

SFP-25GB-DW25-10-I-N3-C

Alcatel-Lucent Nokia® Compatible TAA 25GBase-DWDM 100GHz SFP28 Transceiver (SMF, 1557.36nm, 10km, LC, DOM, -40 to 85C)

Features:

- SFF-8432 and SFF-8472 Compliance
- Duplex LC Connector
- Single-mode Fiber
- Industrial Temperature -40 to 85 Celsius
- Hot Pluggable
- Metal with Lower EMI
- Excellent ESD Protection
- RoHS Compliant and Lead Free



Applications:

- 25x Gigabit Ethernet over DWDM
- Access and Enterprise

Product Description

This Alcatel-Lucent Nokia® SFP28 transceiver provides 25GBase-DWDM throughput up to 10km over single-mode fiber (SMF) using a wavelength of 1557.36nm via an LC connector. It is guaranteed to be 100% compatible with the equivalent Alcatel-Lucent Nokia® transceiver. This easy to install, hot swappable transceiver has been programmed, uniquely serialized and data-traffic and application tested to ensure that it will initialize and perform identically. Digital optical monitoring (DOM) support is also present to allow access to real-time operating parameters. This transceiver is Trade Agreements Act (TAA) compliant. We stand behind the quality of our products and proudly offer a limited lifetime warranty.

ProLabs's transceivers are RoHS compliant and lead-free.

TAA refers to the Trade Agreements Act (19 U.S.C. & 2501-2581), which is intended to foster fair and open international trade. TAA requires that the U.S. Government may acquire only "U.S. – made or designated country end products."



Regulatory Compliance

- ESD to the Electrical PINs: compatible with MIL-STD-883E Method 3015.4
- ESD to the LC Receptacle: compatible with IEC 61000-4-3
- EMI/EMC compatible with FCC Part 15 Subpart B Rules, EN55022:2010
- Laser Eye Safety compatible with FDA 21CFR, EN60950-1& EN (IEC) 60825-1,2
- RoHS compliant with EU RoHS 2.0 directive 2015/863/EU

Wavelength Guide (100GHz ITU Channels)

Channel	Wavelength(nm)	Frequency(THZ)	Channel	Wavelength(nm)	Frequency(THZ)
D21	1560.61	192.1	D41	1544.53	194.1
D22	1559.79	192.2	D42	1543.73	194.2
D23	1558.98	192.3	D43	1542.94	194.3
D24	1558.17	192.4	D44	1542.14	194.4
D25	1557.36	192.5	D45	1541.35	194.5
D26	1556.55	192.6	D46	1540.56	194.6
D27	1555.75	192.7	D47	1539.77	194.7
D28	1554.94	192.8	D48	1538.98	194.8
D29	1554.13	192.9	D49	1538.19	194.9
D30	1553.33	193.0	D50	1537.4	195.0
D31	1552.52	193.1	D51	1536.61	195.1
D32	1551.72	193.2	D52	1535.82	195.2
D33	1550.92	193.3	D53	1535.04	195.3
D34	1550.12	193.4	D54	1534.25	195.4
D35	1549.32	193.5	D55	1533.47	195.5
D36	1548.51	193.6	D56	1532.68	195.6
D37	1547.72	193.7	D57	1531.9	195.7
D38	1546.92	193.8	D58	1531.12	195.8
D39	1546.12	193.9	D59	1530.33	195.9
D40	1545.32	194.0	D60	1529.55	196.0

Absolute Maximum Ratings

Parameter	Symbol	Min.	Typ.	Max.	Unit	Notes
Maximum Supply Voltage	Vcc	-0.3		4.0	V	
Storage Temperature	TS	-40		85	°C	
Operating Case Temperature	Tc	-40		85	°C	
Relative Humidity	RH	0		85	%	
Data Rate	BR	24.33		25.78	Gbps	

Electrical Characteristics

Parameter	Symbol	Min.	Typ.	Max.	Unit	Notes
Supply Voltage	V _{CC}	3.13		3.47		
Power Dissipation	PD			2.0	W	
Transmitter						
Data Input Swing Differential	V _{IN}	190		1000	mV	
Differential line input Impedance	R _{IN}	80	100	120	Ohm	
Transmitter Fault Output-High	V _{FaultH}	2		V _{CC} +0.3	V	
Transmitter Fault Output-Low	V _{FaultL}	V _{EE}		V _{EE} +0.8	V	
Transmitter Disable Voltage-High	V _{DisH}	2		V _{CC} +0.3	V	
Transmitter Disable Voltage- low	V _{DisL}	V _{EE}		V _{EE} +0.8	V	
Receiver						
Differential line Output Impedance	R _{OUT}	80	100	120	Ohm	
Differential Data Output Voltage	V _{DR}	350		850	mVp-p	
LOS Output Voltage-High	V _{LOSH}	2		V _{CC} +0.3	V	
LOS Output Voltage-Low	V _{LOSL}	V _{EE}		V _{EE} +0.8	V	
Others						
Cold-Start time	T _{start-cooled}			35	s	

Optical Characteristics

Parameter	Symbol	Min.	Typ.	Max.	Unit	Notes
Transmitter						
Wavelength	λ	1529.55		1560.61	nm	
Center Wavelength Spacing		100			GHz	
Average Launched Power	P _O	-1		5	dBm	
Extinction Ratio	ER	6			dB	
Average Launched Power (Laser Off)	P _{off}			-30	dBm	
Side-Mode Suppression Ratio	SMSR	30			dB	
Relative Intensity Noise	RIN _{20 OMA}			-130	dB/Hz	
Receiver						
Center Wavelength	λ_{IN}	1260		1620	nm	
Receiver Overload	P _{overload}	2			dBm	
Receiver Sensitivity @5E-5 BOL	P _{sen BOL}			-15	dBm	
Receiver Sensitivity @5E-5 EOL	P _{sen EOL}			-14.5	dBm	1
Receiver Sensitivity @5E-5 EOL after 10km fiber transmission	P _{sen1 EOL}			-9.0	dBm	1
Los Of Signal Assert	PA	-30			dBm	
Los Of Signal De-assert	PD			-16	dBm	
LOS -Hysteresis	P _{Hys}	0.5		6	dB	

Notes:

1. Measured at 5E-5, ER>4dB, PRBS 2³¹ -1

Pin Descriptions

Pin	Symbol	Name/Descriptions	Ref.
1	VEET	Transmitter Ground	1
2	TFAULT	Transmitter Fault	2
3	TDIS	Transmitter Disable. Laser output disabled on high or open.	3
4	SDA	2-wire Serial Interface Data Line	2
5	SCL	2-wire Serial Interface Clock Line	2
6	MOD_ABS	Module Absent. Grounded within the module	2
7	NA	Not Used	
8	RX_LOS	Loss of Signal indication. Logic 0 indicates normal operation.	4
9	NA	No Used	
10	VEER	Receiver Ground	1
11	VEER	Receiver Ground	1
12	RD-	Receiver Inverted DATA out. AC Coupled.	
13	RD+	Receiver Non-inverted DATA out. AC Coupled.	
14	VEER	Receiver Ground	1
15	VCCR	Receiver Power Supply	5
16	VCCT	Transmitter Power Supply	5
17	VEET	Transmitter Ground	1
18	TD+	Transmitter Non-Inverted DATA in. AC Coupled.	
19	TD-	Transmitter Inverted DATA in. AC Coupled.	
20	VEET	Transmitter Ground	1

Notes:

1. Circuit ground is internally isolated from chassis ground.
2. T_{FAULT} is an open collector/drain output, which should be pulled up with a 4.7k – 10k Ohms resistor on the host board if intended for use. Pull up voltage should be between 2.0V to V_{cc} + 0.3V. A high output indicates a transmitter fault caused by either the TX bias current or the TX output power exceeding the preset alarm thresholds. A low output indicates normal operation. In the low state, the output is pulled to <0.8V.
3. Laser output disabled on T_{DIS} >2.0V or open, enabled on T_{DIS} <0.8V.
4. LOS is open collector output. Should be pulled up with 4.7k – 10kΩ on host board to a voltage between 2.0V and 3.6V. Logic 0 indicates normal operation; logic 1 indicates loss of signal.
5. Internally connected



Pin-out of connector Block on Host board

Block Diagram of Transceiver



Recommended Interface Circuit

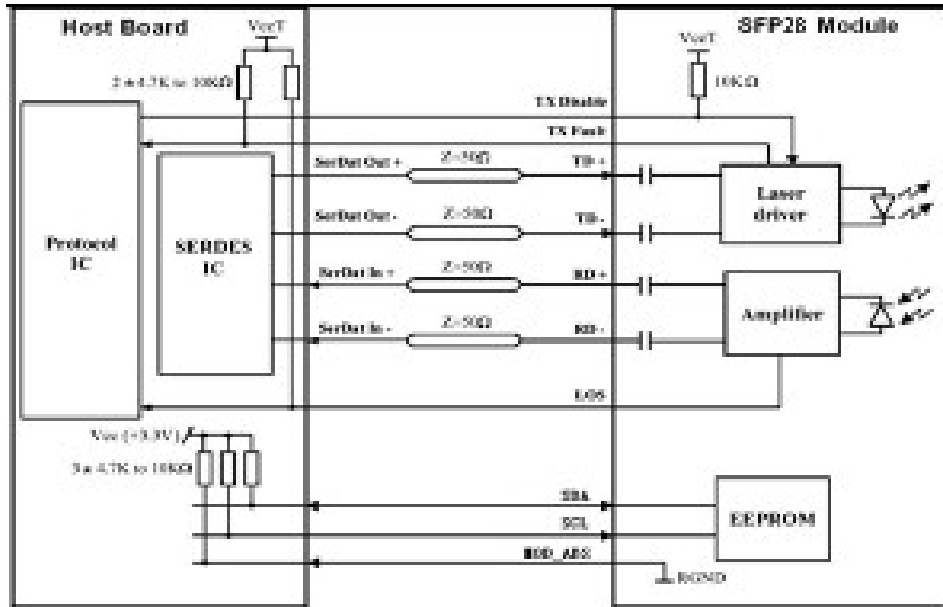

Mechanical Specifications

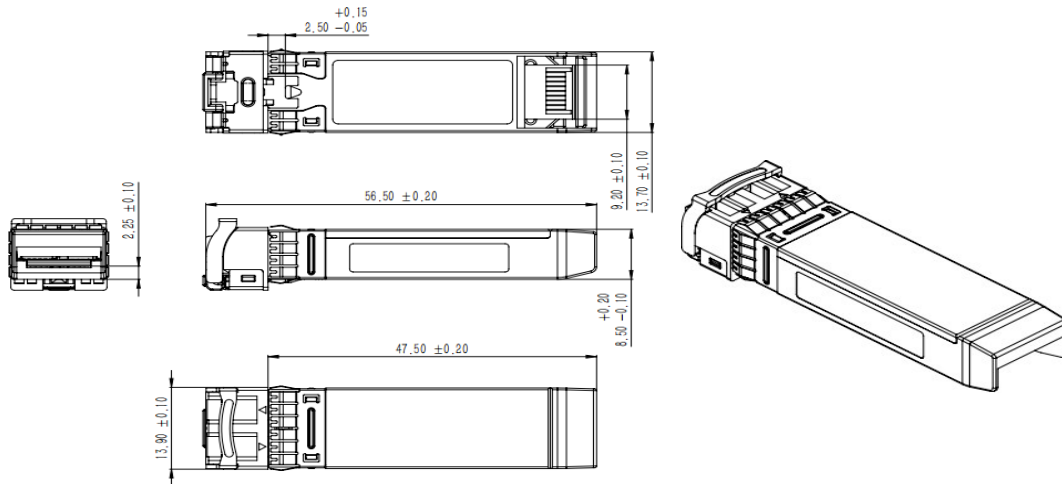

About ProLabs

Our experience comes as standard; for over 15 years ProLabs has delivered optical connectivity solutions that give our customers freedom and choice through our ability to provide seamless interoperability. At the heart of our company is the ability to provide state-of-the-art optical transport and connectivity solutions that are compatible with over 90 optical switching and transport platforms.

Complete Portfolio of Network Solutions

ProLabs is focused on innovations in optical transport and connectivity. The combination of our knowledge of optics and networking equipment enables ProLabs to be your single source for optical transport and connectivity solutions from 100Mb to 400G while providing innovative solutions that increase network efficiency. We provide the optical connectivity expertise that is compatible with and enhances your switching and transport equipment.

Trusted Partner

Customer service is our number one value. ProLabs has invested in people, labs and manufacturing capacity to ensure that you get immediate answers to your questions and compatible product when needed. With Engineering and Manufacturing offices in the U.K. and U.S. augmented by field offices throughout the U.S., U.K. and Asia, ProLabs is able to be our customers best advocate 24 hours a day.

Contact Information

ProLabs US

Email: sales@prolabs.com

Telephone: 952-852-0252

ProLabs UK

Email: salessupport@prolabs.com

Telephone: +44 1285 719 600