

MAX15062AEVKIT# Evaluation Kit

Evaluates: MAX15062A

General Description

The MAX15062AEVKIT# evaluation kit (EV kit) is a fully assembled and tested circuit board that demonstrates the performance of the MAX15062A 60V, 300mA ultra-small, high-efficiency, synchronous step-down converter. The EV kit operates over a wide 4.5V to 60V input voltage range, and provides up to 300mA at the preset 3.3V output. The device features undervoltage lockout, overcurrent protection, and thermal shutdown. The EV kit switches at a fixed frequency of 500kHz, and delivers a peak efficiency of 90% with the supplied components.

The EV kit comes installed with the MAX15062AATA+ in an 8-pin (2mm x 2mm) lead(Pb)-free/RoHS-compliant TDFN package.

Features

- 4.5V to 60V Input Voltage Range (Note 1)
- 3.3V Output, 300mA Continuous Current
- Internal Compensation
- EN/UVLO for On/Off Control and Programmable Input Undervoltage Lockout
- 90% Peak Efficiency
- 500kHz Fixed-Frequency PWM Operation
- PFM or Forced-PWM Mode of Operation
- Hiccup Mode Overcurrent Protection
- Open-Drain $\overline{\text{RESET}}$ Output
- Thermal Shutdown
- Proven PCB Layout
- Fully Assembled and Tested

Ordering Information appears at end of data sheet.

Note 1: In PWM mode, operation at input voltages greater than 51V can cause the converter to reach its minimum controllable ON time ($t_{\text{on-min}}$), resulting in the increased inductor current ripple and output voltage ripple, especially at light load conditions. However, the average output voltage is regulated.

Quick Start

Recommended Equipment

- MAX15062AEVKIT# EV kit
- 60V adjustable, 0.5A DC power supply
- Load capable of sinking 300mA
- Voltmeter

Equipment Setup and Test Procedure

The EV kit is fully assembled and tested. Follow the steps below to verify board operation.

Caution: Do not turn on the power supply until all connections are completed.

- 1) Set the power supply at a voltage between 4.5V and 60V. Then, disable the power supply.
- 2) Connect the positive terminal of the power supply to the VIN PCB pad and the negative terminal to the nearest GND PCB pad. Connect the positive terminal of the 300mA load to the VOUT PCB pad and the negative terminal to the nearest GND PCB pad.
- 3) Connect the Multimeter across the VOUT PCB pad and the nearest GND PCB pad.
- 4) Verify that shunts are installed on jumpers JU1 and JU2 (EN/UVLO).
- 5) Verify that shunt is open on jumpers JU3 for PFM mode of operation.
- 6) Turn on the DC power supply.
- 7) Enable the load.
- 8) Verify that the multimeter displays 3.3V.

Detailed Description

The MAX15062AEVKIT# is a fully assembled and tested circuit board that demonstrates the performance of the MAX15062A 60V, 300mA ultra-small, high-efficiency, synchronous step-down converter. The EV kit operates over a wide 4.5V to 60V input voltage range, and provides up to 300mA at the preset 3.3V output. The device features undervoltage lockout, overcurrent protection, and thermal shutdown. The EV kit switches at a fixed frequency of 500kHz, and delivers a peak efficiency of 90% with the supplied components.

The EV kit includes an EN/UVLO PCB pad and jumpers JU1 and JU2 to enable control of the converter output. Jumper JU3 allows the selection of the mode of operation based on light load-performance requirements. An additional RESET PCB pad is available for monitoring whether the converter output is in regulation or not.

Enable/Undervoltage-Lockout (EN/UVLO) Programming

The MAX15062 offers an Enable and adjustable input undervoltage-lockout feature. In this EV kit, for normal operation, leave EN/UVLO jumpers (JU1 and JU2) with shunts installed. When JU1 and JU2 have shunts installed, the MAX15062 is enabled when the input voltage rises above 4.5V. To disable MAX15062, install a jumper on JU2 and keep JU1 in an open position. See [Table 1](#) for JU1 settings. The EN/UVLO PCB pad on the EV kit supports external Enable/Disable control of the device. Leave JU1 and JU2 open when external Enable/Disable control is desired. A potential divider formed by R1 and R2 sets the input voltage (V_{INU}) above which the converter is enabled when JU1 and JU2 are closed.

Choose R1 to be 2.2M Ω (max) and then calculate R2 as follows:

$$R2 = \frac{R1 \times 1.215}{(V_{INU} - 1.215)}$$

where, V_{INU} = Voltage at which the device is required to turn on, and R1 and R2 are in k Ω .

Refer to the *Enable Input (EN/UVLO) Soft-Start* section in the MAX15062 data sheet for additional information on setting the UVLO threshold voltage.

Active-Low Open-Drain Reset Output (RESET)

The EV kit provides a $\overline{\text{RESET}}$ PCB pad to monitor the status of the $\overline{\text{RESET}}$ output. $\overline{\text{RESET}}$ goes high when VOUT rises above 95% (typ) of its nominal regulated output voltage. When VOUT falls below 92% (typ) of its nominal regulated voltage, $\overline{\text{RESET}}$ is pulled low.

Mode of Operation

The EV kit features fixed frequency PWM mode and PFM mode of operation for higher efficiency at light-load conditions. The mode can be selected by programming the jumper JU3 on the EV kit. Install a shunt on JU3 to operate in PWM mode, leave JU3 in open position for PFM mode of operation. The EV kit is set to PFM mode of operation by default. Refer to the MAX15062 data sheet for more details on the modes of operation.

Hot Plug-In and Long Input Cables

The MAX15062AEVKIT# PCB layout provides an optional electrolytic capacitor ($C1 = 22\mu\text{F}/100\text{V}$). This capacitor limits the peak voltage at the input of the MAX15062 when the DC input source is “Hot-Plugged” to the EV kit input terminals with long input cables. The equivalent series resistance (ESR) of the electrolytic capacitor dampens the oscillations caused by interaction of the inductance of the long input cables, and the ceramic capacitors at the buck converter input.

Table 1. Converter EN/UVLO Jumper (JU1 & JU2) Settings

SHUNT POSITION		EN/UVLO PIN	VOUT OUTPUT
JU1	JU2		
1-2	Open	Connected to VIN	Enabled
Open	1-2	Connected to GND	Disabled
1-2*	1-2	Connected to midpoint of the R1, R2 resistor-divider	Enabled at $V_{IN} \geq 4.5\text{V}$

*Default position.

Table 2. Mode Selection Jumper (JU3) Settings

SHUNT POSITION	MODE PIN	MODE OF OPERATION
1-2	Connected to GND	Forced PWM
Open*	Unconnected	PFM

*Default position.

EV Kit Performance Report

($V_{IN} = 24V$, $V_{OUT} = 3.3V$, $f_{SW} = 500kHz$, unless otherwise noted.)

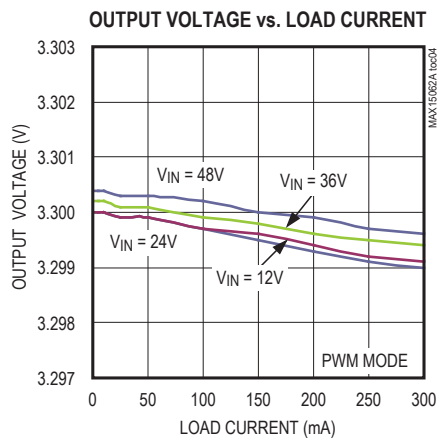
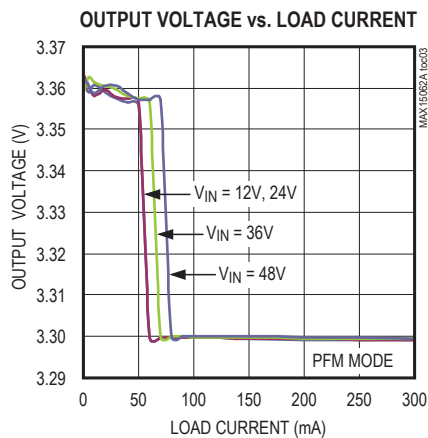
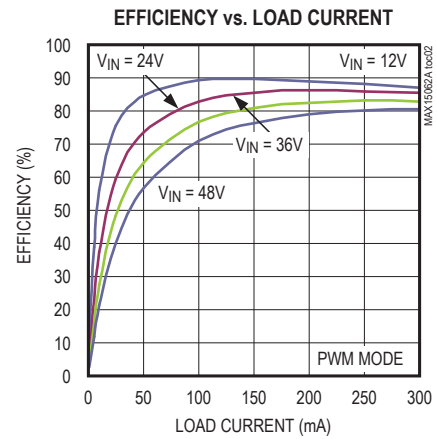
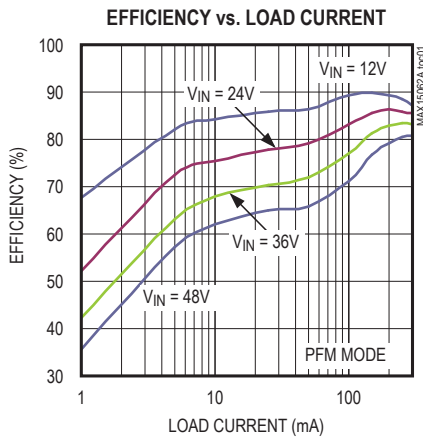

**LOAD TRANSIENT RESPONSE—
PFM MODE (LOAD CURRENT
STEPPED FROM 5mA TO 150mA)**

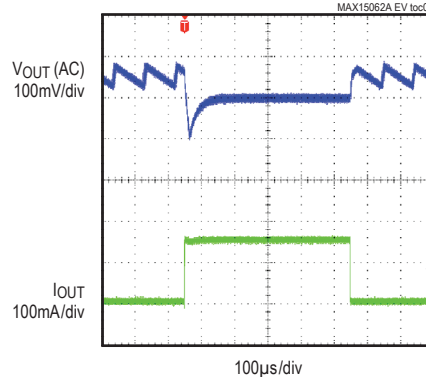

EV Kit Performance Report (continued)

($V_{IN} = 24V$, $V_{OUT} = 3.3V$, $f_{SW} = 500kHz$, unless otherwise noted.)

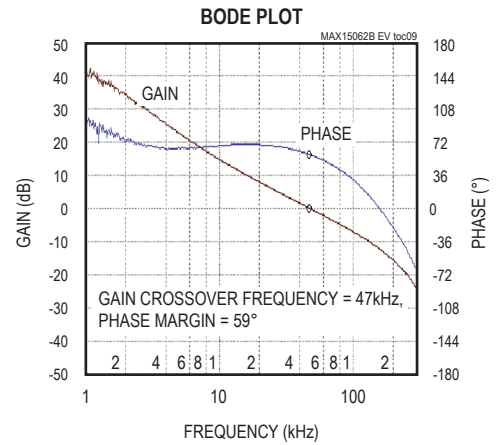
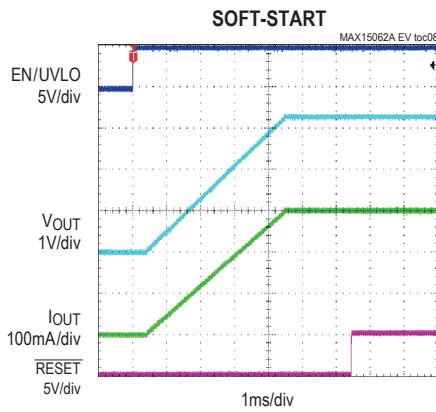
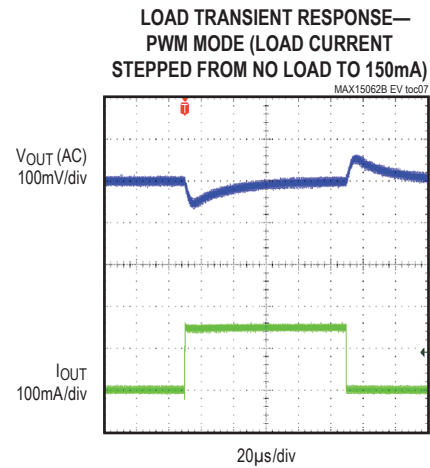
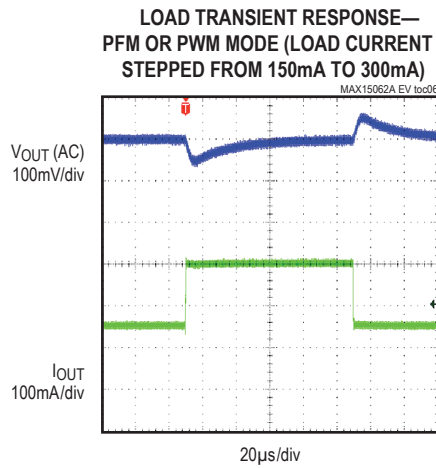

Component Suppliers

SUPPLIER	WEBSITE
Coilcraft, Inc.	www.coilcraft.com
Murata Americas	www.murata.com
Panasonic Corp.	www.panasonic.com
SullinsCorp	www.sullinscorp.com

Note: Indicate that you are using the MAX15062 when contacting these component suppliers.

Ordering Information

PART	TYPE
MAX15062AEVKIT#	EV Kit

#Denotes a RoHS-compliant device that may include lead(Pb) that is exempt under the RoHS requirements.

MAX15062AEVKIT# EV Kit Bill of Materials

S.No	DESIGNATOR	DESCRIPTION	QUANTITY	MANUFACTURER PART NUMBER
1	C1	22µF, 20%, 100V, Electrolytic capacitor	1	PANASONIC EEEHA2A220UP
2	C2	1µF, 10%, 100V, X7R, Ceramic capacitor (1206)	1	MURATA GRM31CR72A105KA
3	C3	1µF, 10%, 6.3V, X7R, Ceramic capacitor (0603)	1	MURATA GRM188R70J105K
4	C4	10µF, 10%, 6.3V, X7R, Ceramic capacitor (1206)	1	MURATA GRM31CR70J106K
5	JU1, JU2, JU3	2-pin header (36-pin header 0.1" centers)	3	SULLINS PEC02SAAN
6	L1	INDUCTOR, 33µH, 0.68A	1	COILCRAFT LPS4018-333ML
7	R1	2.2MΩ, ±1%, 1/10W, resistor (0402)	1	
8	R2	806kΩ, ±1%, 1/10W, resistor (0402)	1	
9	R3	100kΩ, ±1%, 1/10W, resistor (0402)	1	
10	U1	Integrated Step-down Converter, MAX15062A	1	MAXIM MAX15062AATA+

DEFAULT JUMPER TABLE	
JUMPER	SHUNT POSITION
JU1, JU2	Close
JU3	Open

MAX15062AEVKIT# EV Kit Schematic

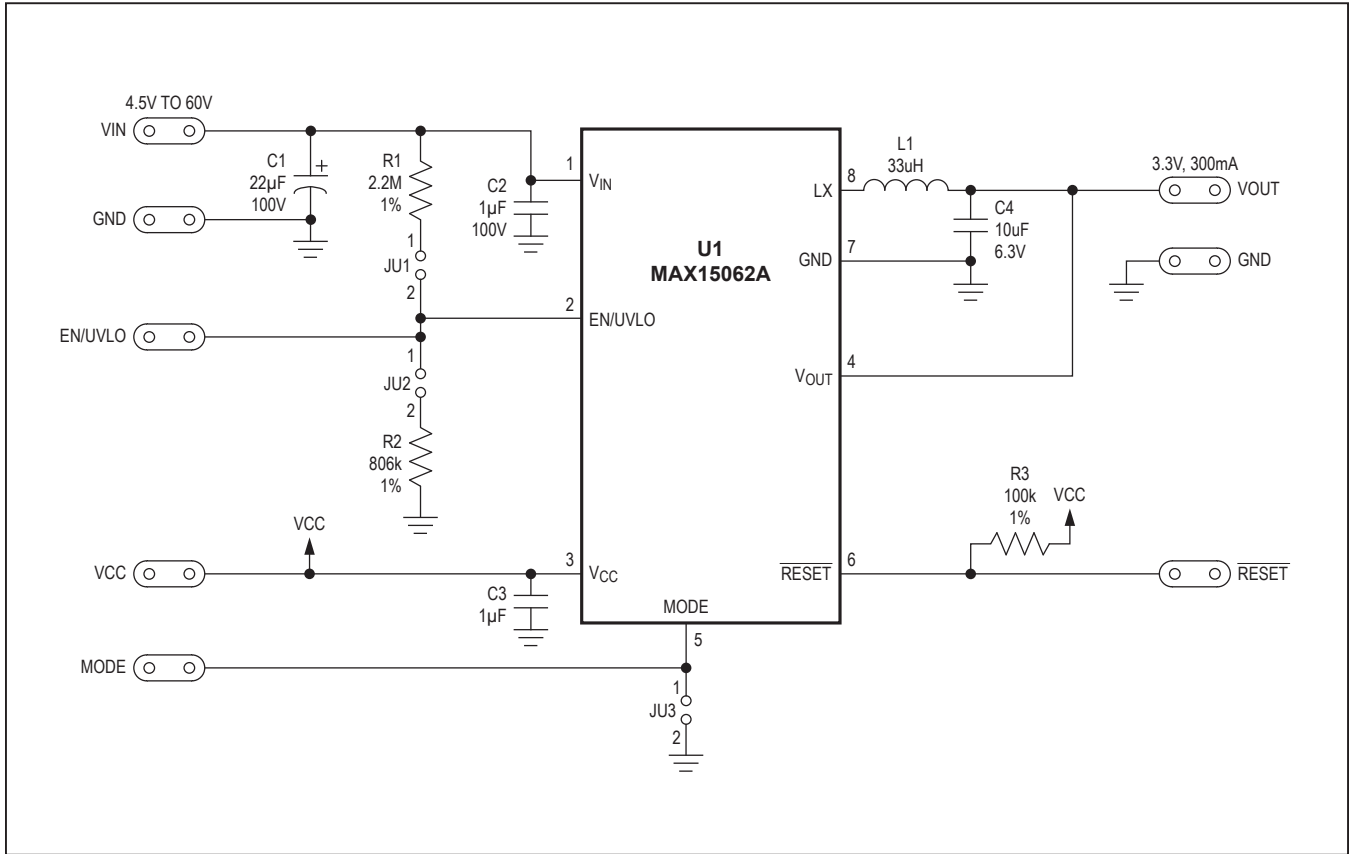

MAX15062AEVKIT# EV Kit PCB Layout

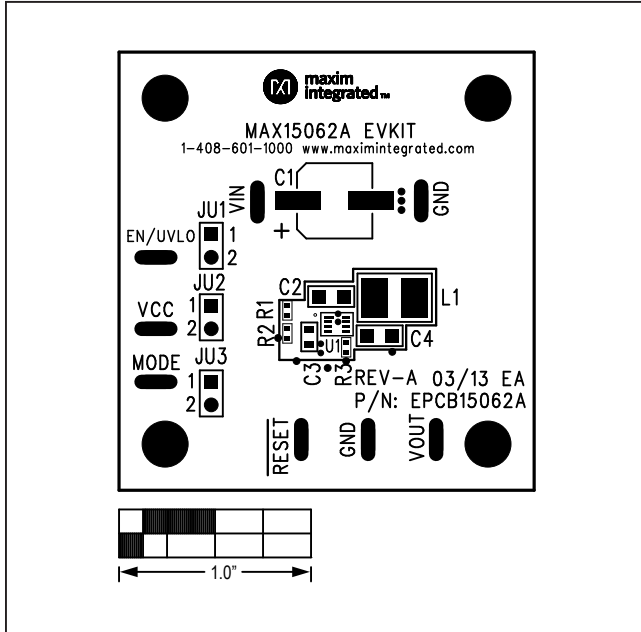

MAX15062AEVKIT# EV Kit—Top Silkscreen

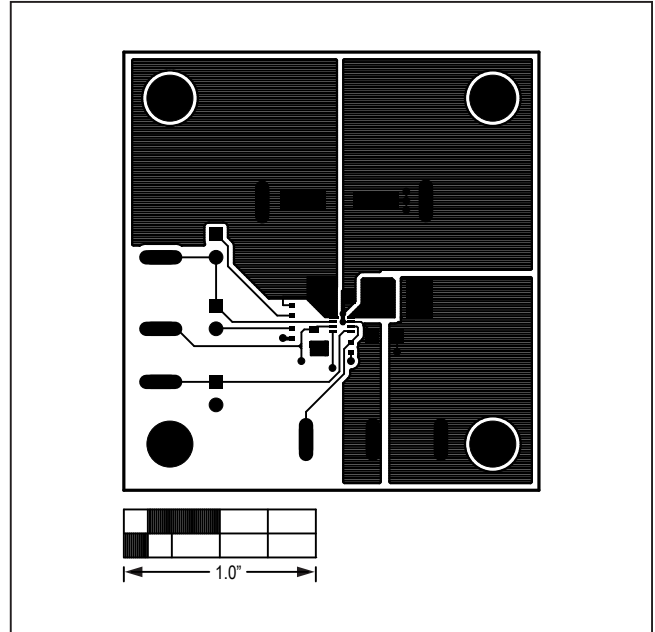

MAX15062AEVKIT# EV Kit—Top Layer

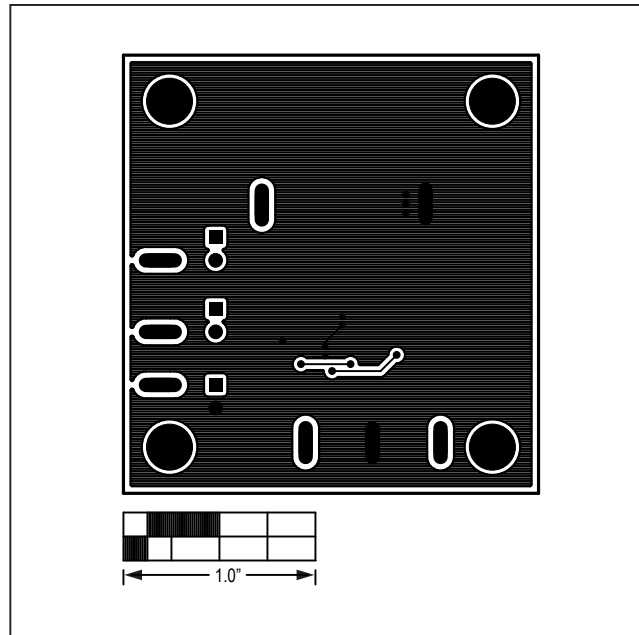

MAX15062AEVKIT# EV Kit—Bottom Layer

Revision History

REVISION NUMBER	REVISION DATE	DESCRIPTION	PAGES CHANGED
0	4/13	Initial release	—
1	5/19	Update the title and <i>Features, Quick Start, Equipment Setup and Test Procedures, Detailed Description, Active-Low Open-Drain Reset Output (\overline{RESET}) and EV Kit Performance Report</i> sections, and TOC09; replaced the <i>Enable/Undervoltage-Lockout (EN/UVLO) Programming, Mode of Operation, Hot Plug-In and Long Input Cables, Component Suppliers, and Bill of Materials</i> sections	1–8

For pricing, delivery, and ordering information, please visit Maxim Integrated's online storefront at <https://www.maximintegrated.com/en/storefront/storefront.html>.

Maxim Integrated cannot assume responsibility for use of any circuitry other than circuitry entirely embodied in a Maxim Integrated product. No circuit patent licenses are implied. Maxim Integrated reserves the right to change the circuitry and specifications without notice at any time.