

ITEM NO.	PART NUMBER	DESCRIPTION	QTY.	COMPONENT NOTES
1	50-00989	Connector, 6 pin M12 A-code plug, 12xL22mm, gold plated, molding style, solder cup, IP67, shielded	1	
2	30-01595	Wire, 6C TS, 24 AWG, UL20387, 300V, 105C, 60C oil, UV, 6.3 mm, shielded, VW-1, PVC, 80A, black	1	
3	24-00349	Overmold, M12 plug and jack, 180°	1	PVC, black
4	Heat shrink	Heat shrink, black	1	covers drain
5	Heat shrink	Heat shrink, black	1	covers end of jacket

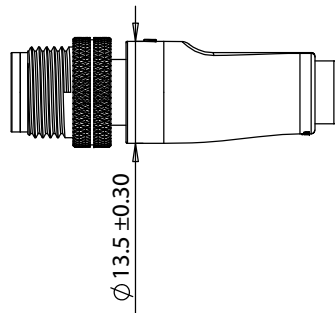
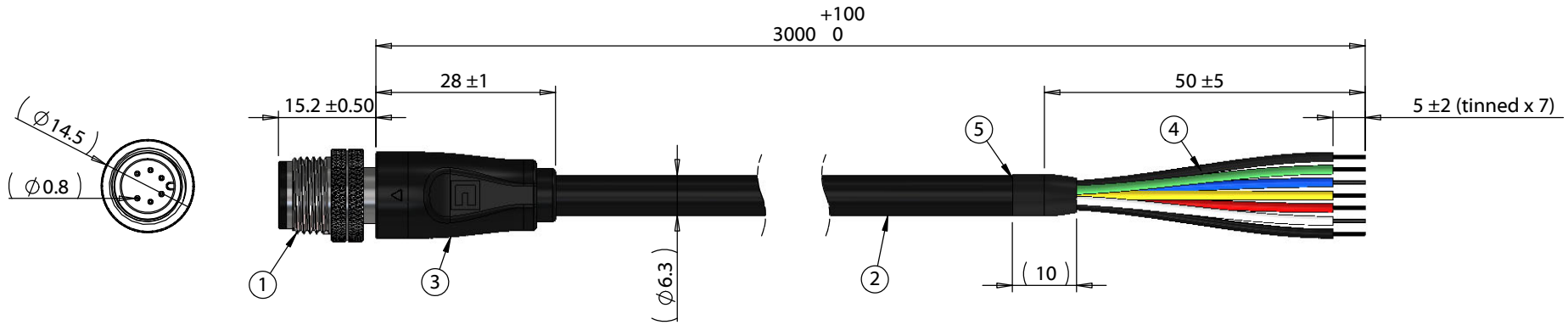

Notes:
 Cable rated for 30 V, 2 A
 Temperature: -40 ~ 105 °C
 Oil resistant up to 60 °C
 Water resistant up to 75 °C
 UV resistant

IP67 waterproof rating when mated with corresponding (IP67) connector

Functionally equivalent components may be substituted

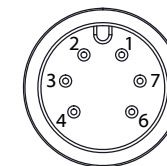

Front View
Not to Scale

Wiring Diagram	
50-00989	wire color
1	red
2	yellow
3	black
4	white
6	blue
7	green
Shell	shield/drain

Revision:	Date:	Description:	Prepared:	Notes:	<h1>TENSILITY</h1> <p>tel 1.541.323.3228 800 877.670.7118 fax 1.541.323.4202 web tensility.com</p>
A	10/15/2020	Initial release	Verified:	RoHS compliant	
			Dimensions are in millimeters. Tolerances: X: ± 0.5 mm X.X: ± 0.3 mm X.XX: ± 0.05 mm	Function test: no open, no short circuit, no intermittent	
				Description: Cable, 3000 mm, 0.8 mm 6C 50-00989 M12 plug to 5 mm tinned, 24 AWG, 30-01595 wire, shielded	
				Size:	Part number:
				A	10-03834
				Scale: 1:1	Sheet 1 of 1

5

4

3

2

1