

## SPECIFICATION

- Part No. : **GW.17.07.0250E**
- Product Name : 2.4GHz 2dBi Click-in Terminal Dipole Antenna  
250mm RG-178 cable IPEX MHFI
- Feature : High radiation performance  
Stable efficiency, gain and radiation patterns on  
different mounting environments and  
ground-planes  
Hinged 90 degrees  
RoHS Compliant



## 1. Introduction

The GW.17 Click-in Terminal Antenna is a high performance robust 2.4GHz dipole antenna designed for quick assembly onto finished products. The specially designed click in plastic head greatly reduces the assembly time and cost compared with most terminal antennas with connector. The standard product comes with 250mm low loss RG-178 cable and IPEX MHFI (U.FL) connector. Having the cable and IPEX connector coming out directly from the housing eliminates the need for a separate costly cable assembly and bulky mating connector on the device.

Many module manufacturers specify peak gain limits for any antennas that are to be connected to that module. Those peak gain limits are based on free-space conditions. In practice, the peak gain of an antenna tested in free-space can degrade by at least 1 or 2dBi when put inside a device. So ideally you should go for a slightly higher peak gain antenna than mentioned on the module specification to compensate for this effect, giving you better performance.

Upon testing of any of our antennas with your device and a selection of appropriate layout, integration technique, or cable, Taoglas can make sure any of our antennas' peak gain will be below the peak gain limits. Taoglas can then issue a specification and/or report for the selected antenna in your device that will clearly show it complying with the peak gain limits, so you can be assured you are meeting regulatory requirements for that module.

For example, a module manufacturer may state that the antenna must have less than 2dBi peak gain, but you don't need to select an embedded antenna that has a peak gain of less than 2dBi in free-space. This will give you a less

optimized solution. It is better to go for a slightly higher free-space peak gain of 3dBi or more if available. Once that antenna gets integrated into your device, performance will degrade below this 2dBi peak gain due to the effects of GND plane, surrounding components, and device housing. If you want to be absolutely sure, contact Taoglas and we will test. Choosing a Taoglas antenna with a higher peak gain than what is specified by the module manufacturer and enlisting our help will ensure you are getting the best performance possible without exceeding the peak gain limits.

The GW.17 has excellent stable radiation properties in all mounting conditions, mounted with and without a ground-plane, in bent 90 degrees or straight position.

Cable length and connector type

## 2. Specification

ELECTRICAL	
Frequency	2.4 ~ 2.5GHz,
Peak Gain (straight)	2.7dBi
Peak Gain (bend)	1.6dBi
Average Gain (straight)	-1.3dBi
Average Gain (bend)	-1.3dBi
Efficiency (straight)	74%
Efficiency (bend)	74%
Polarization	Linear
Impedance	50 Ohms
Radiation Pattern	Omni
Input Power	2W max.
MECHANICAL	
Antenna Length	112.6mm
Antenna Diameter	9.3mm
Antenna Body Material	TPU
ENVIRONMENTAL	
Temperature Range	-40°C to 85°C
Humidity	Non-condensing 65°C 95% RH

### 3. Antenna S11 Property

#### 3.1. Return Loss

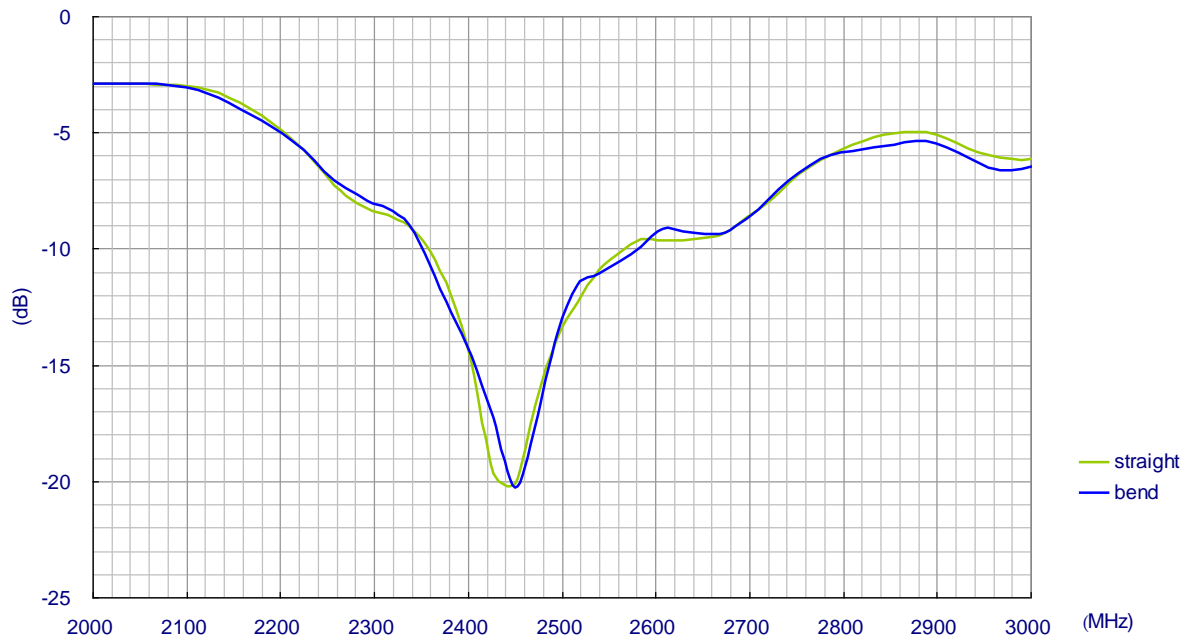

#### 3.2. VSWR

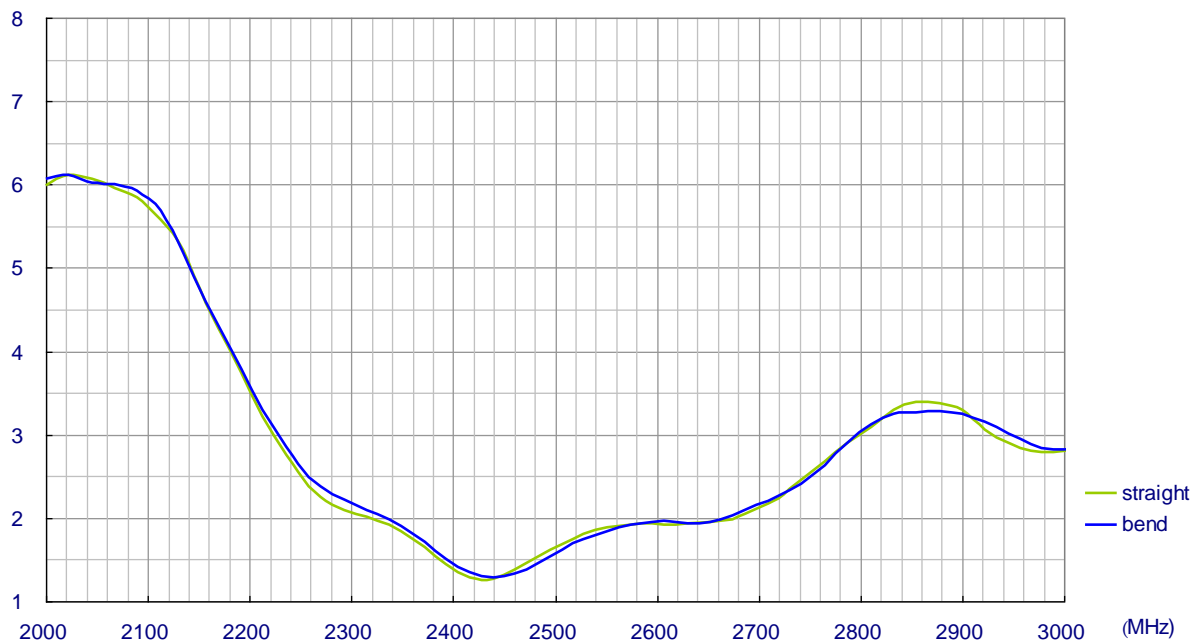

## 4. 3D Radiation Property

### 4.1. Radiation Efficiency

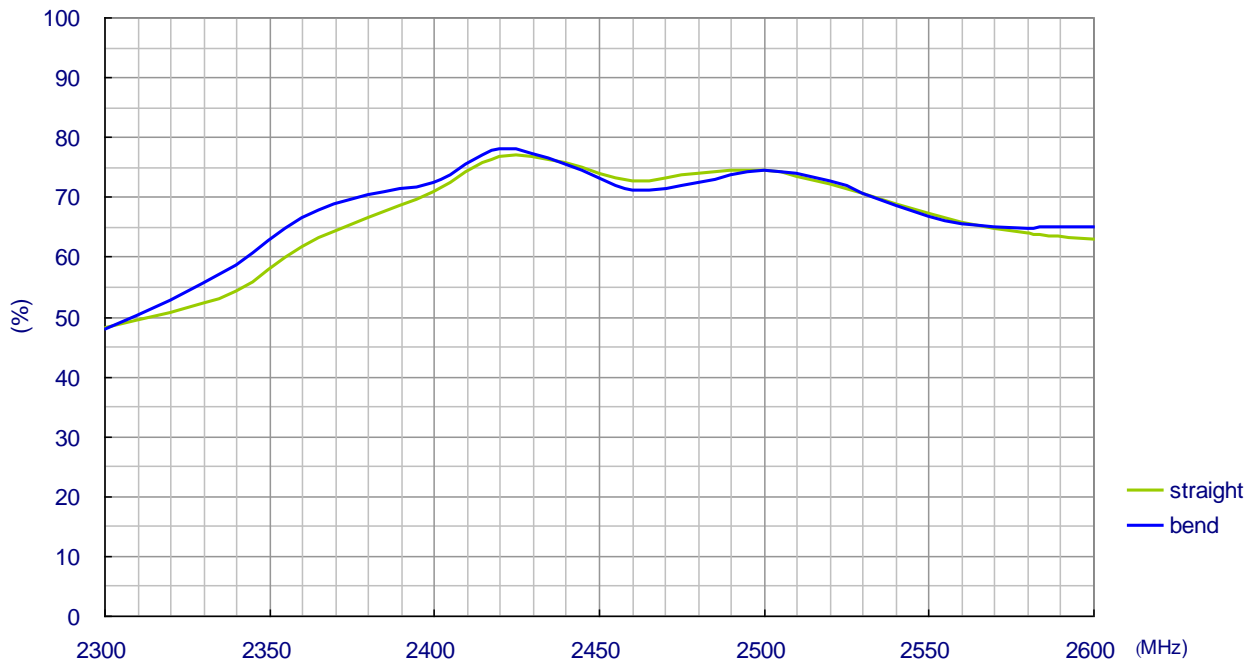

### 4.2. Peak Gain

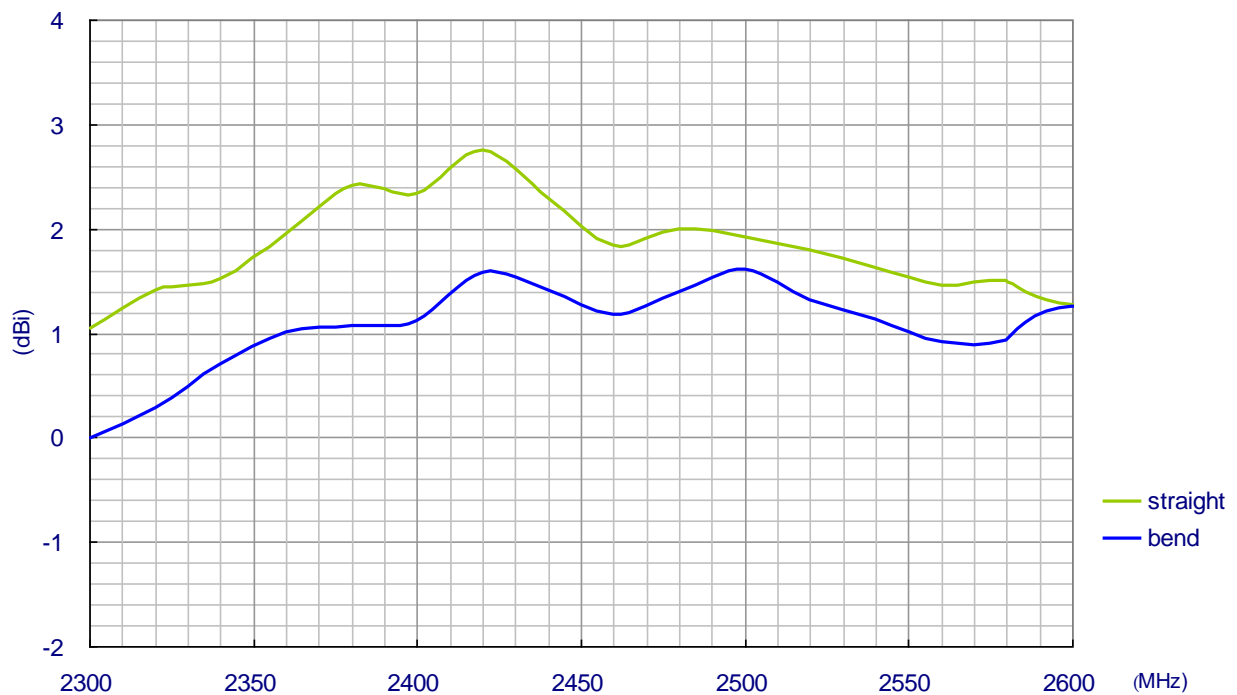

### 4.3. Average Gain

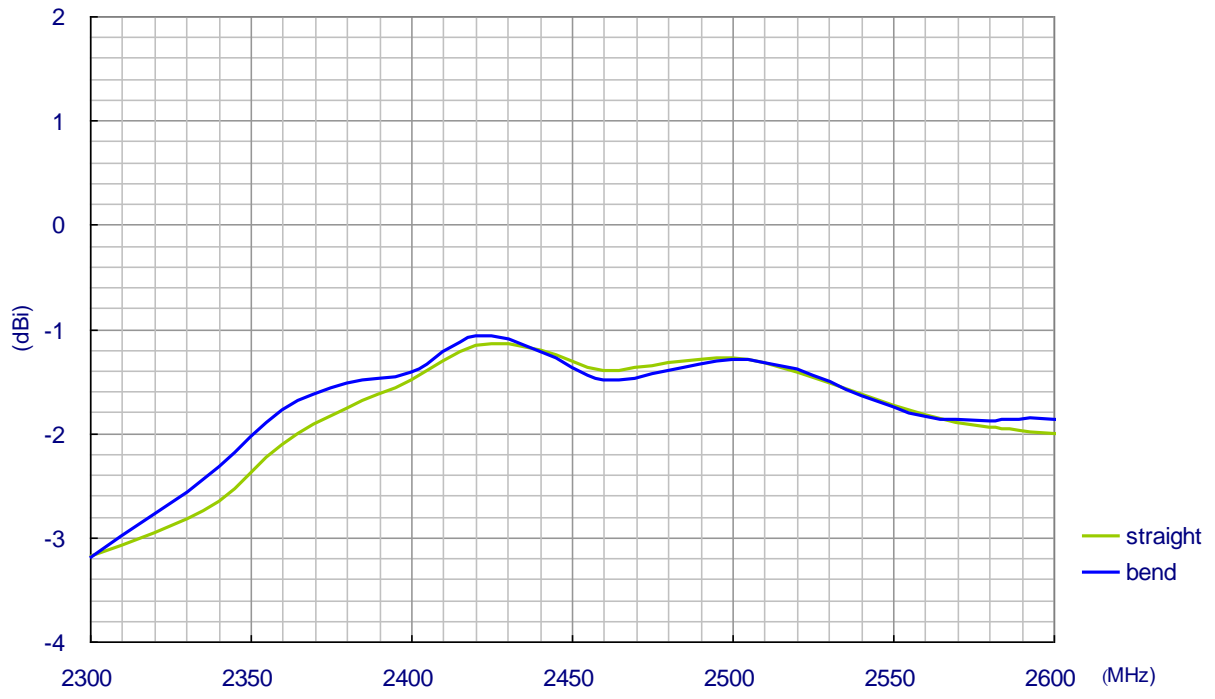

## 4.4. Radiation Pattern

### E-Plane Radiation of Straight Position

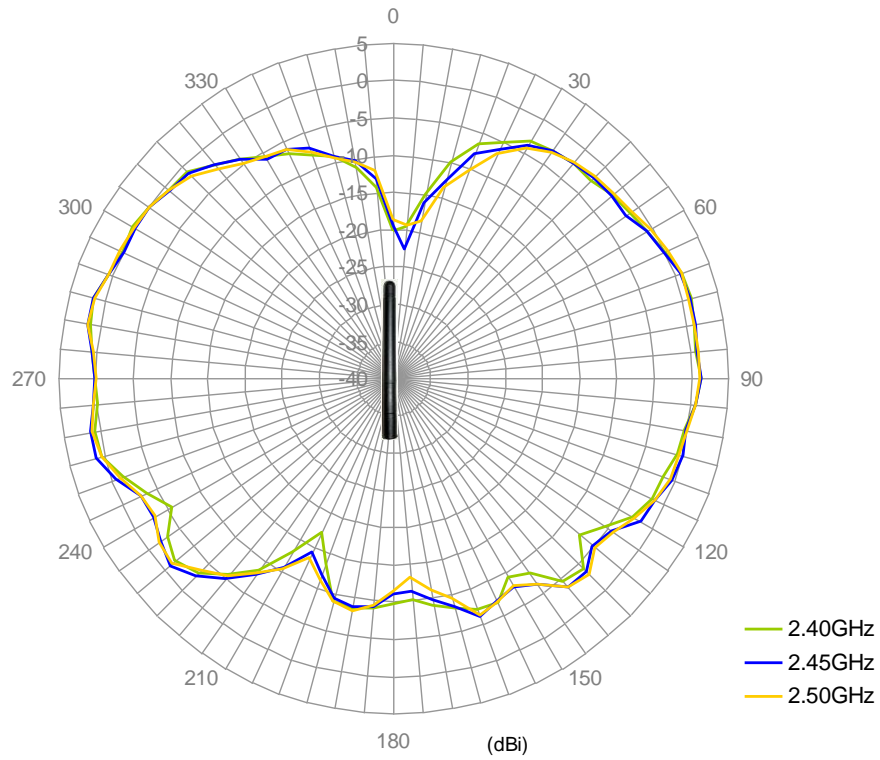



## H-Plane Radiation of Straight Position

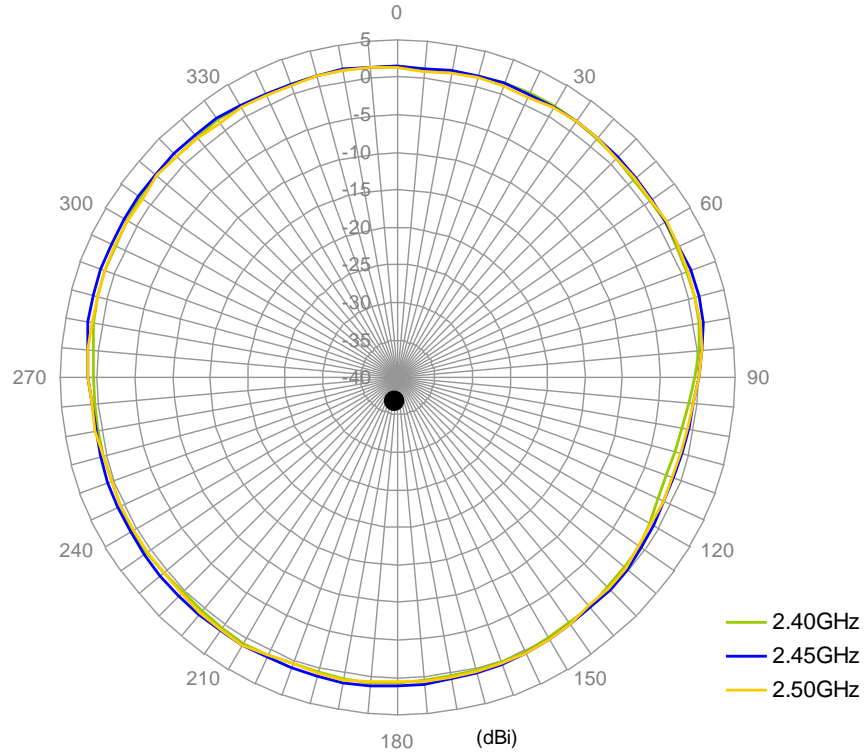

## E-Plane Radiation of Bend Position

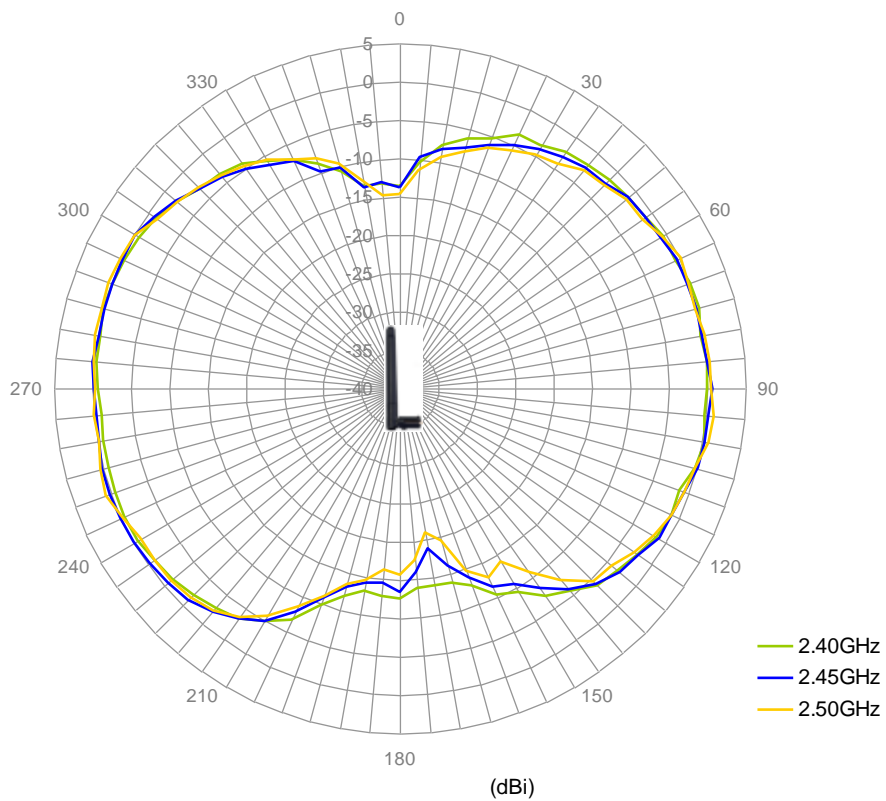

## H-Plane Radiation of Bend Position

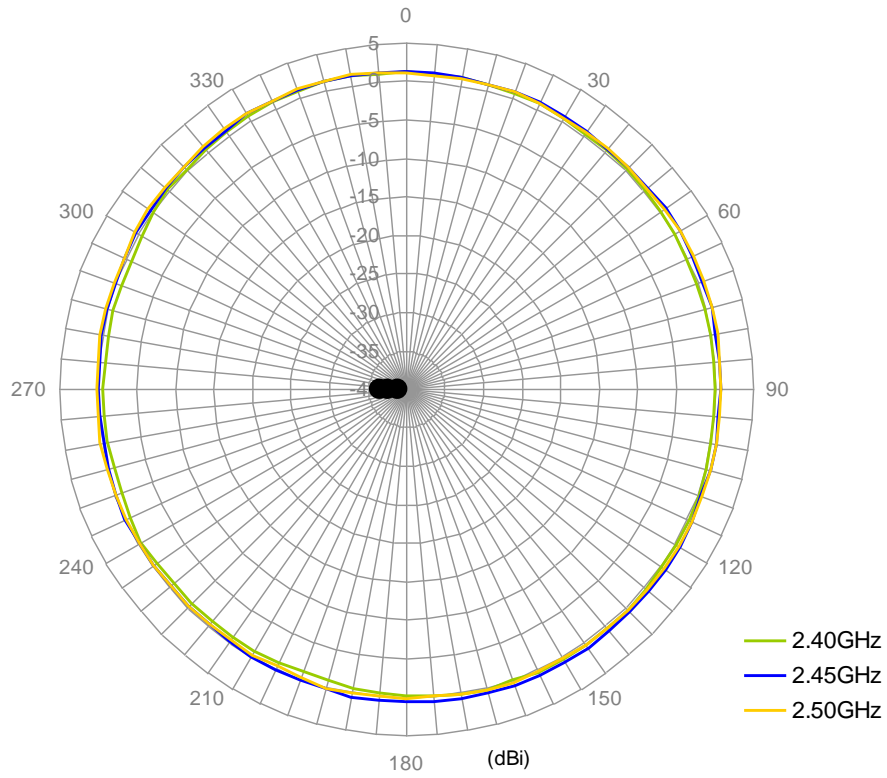

## 5. Ground Plane Effect

Three ground setups are used to see the affect of positioning GW.17 close to ground -

1. Small Ground (15 x 9cm) – common size of CPE devices. GW.17 is mounted at the longer edge for testing.
2. Big Ground Edge (45 x 30cm) – simulate the effect of mounting antenna on a base station device. GW.17 is mounted at the centre of the longer edge.
3. Big Ground Centre (45 x 30cm) – simulate the effect of mounting antenna in a centre of a big ground plane, such as vehicle top.

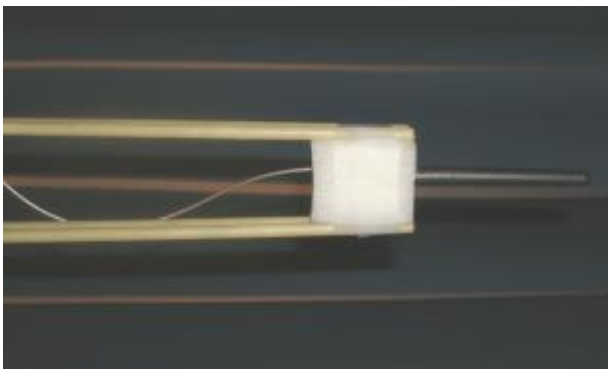

Free space

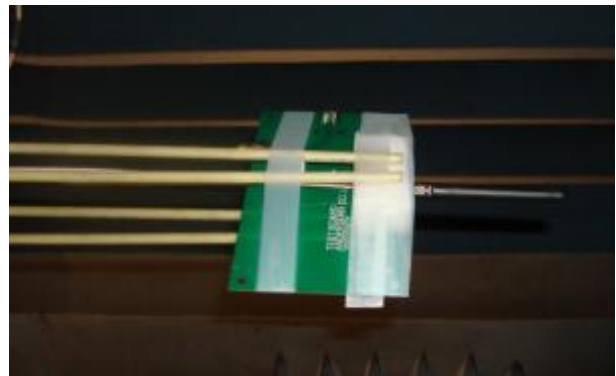

Small ground edge

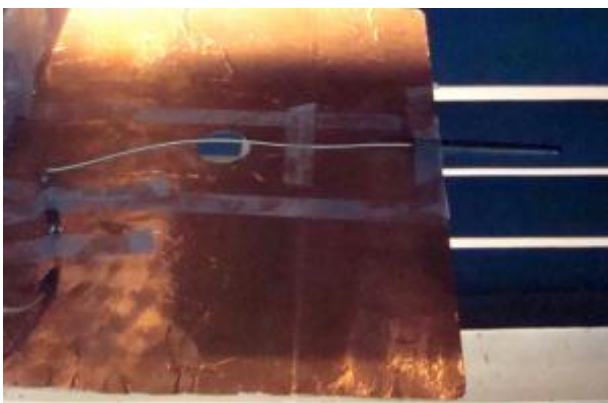

Big ground edge



Big ground center

## 6. Radiation Property of GW.17 Different Ground

### 6.1. Radiation Efficiency of Straight GW.17

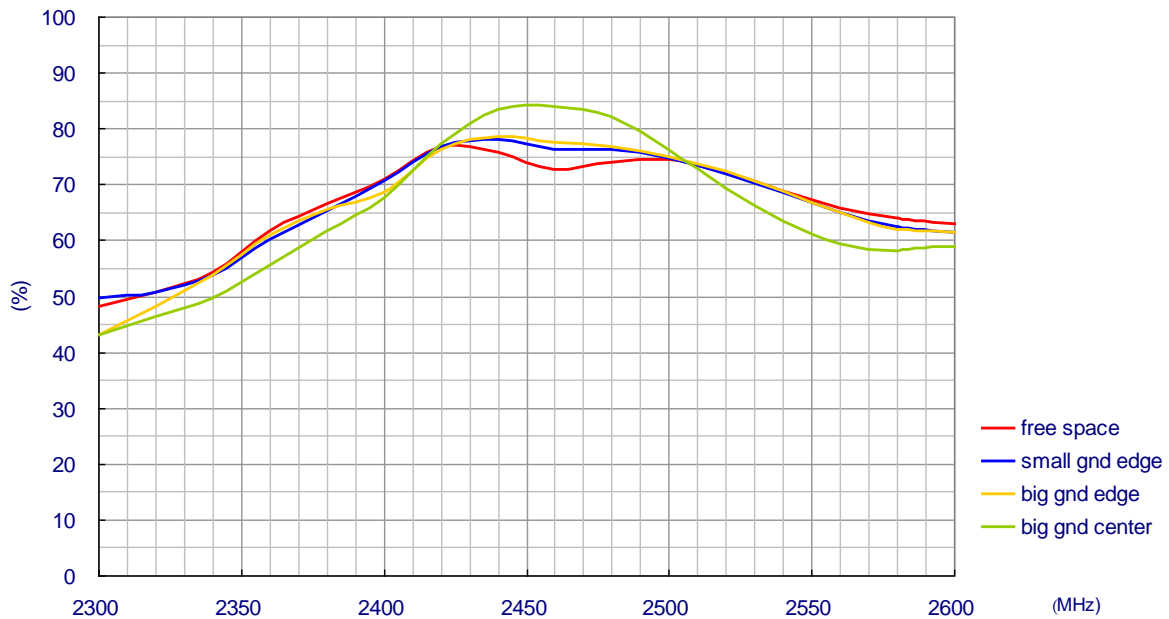

### 6.2. Radiation Efficiency of Bend GW.17

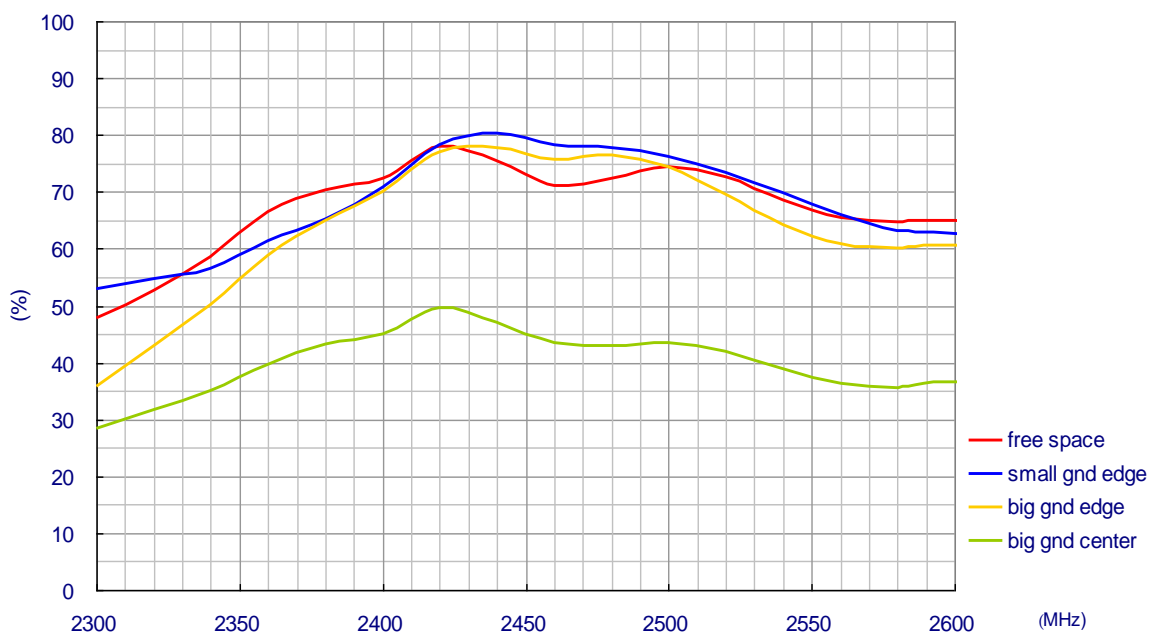

### 6.3. Peak Gain of Straight GW.17

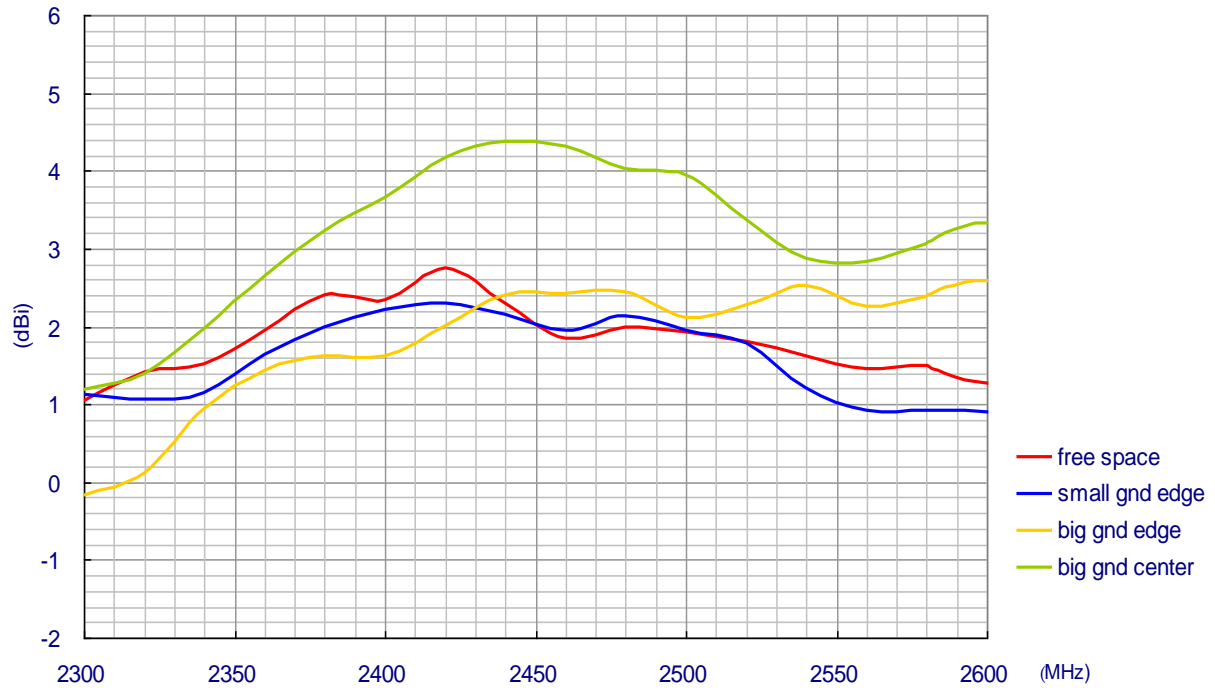

### 6.4. Peak Gain of Bend GW.17

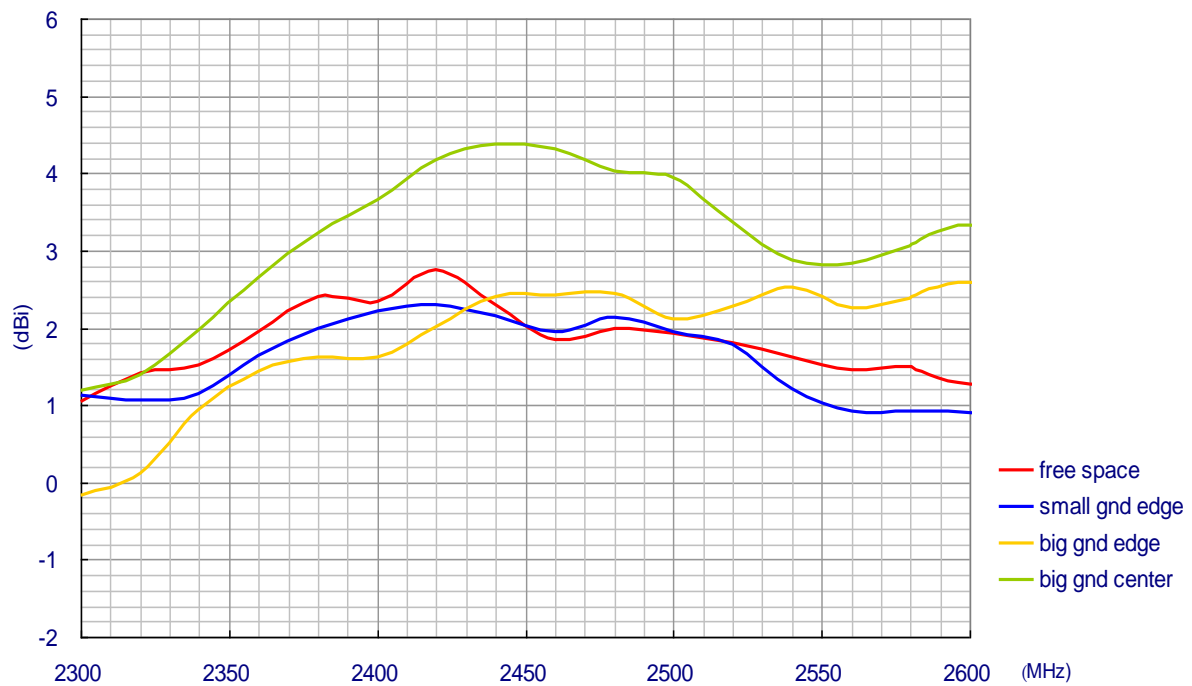

### 6.5. Average Gain of Straight GW.17

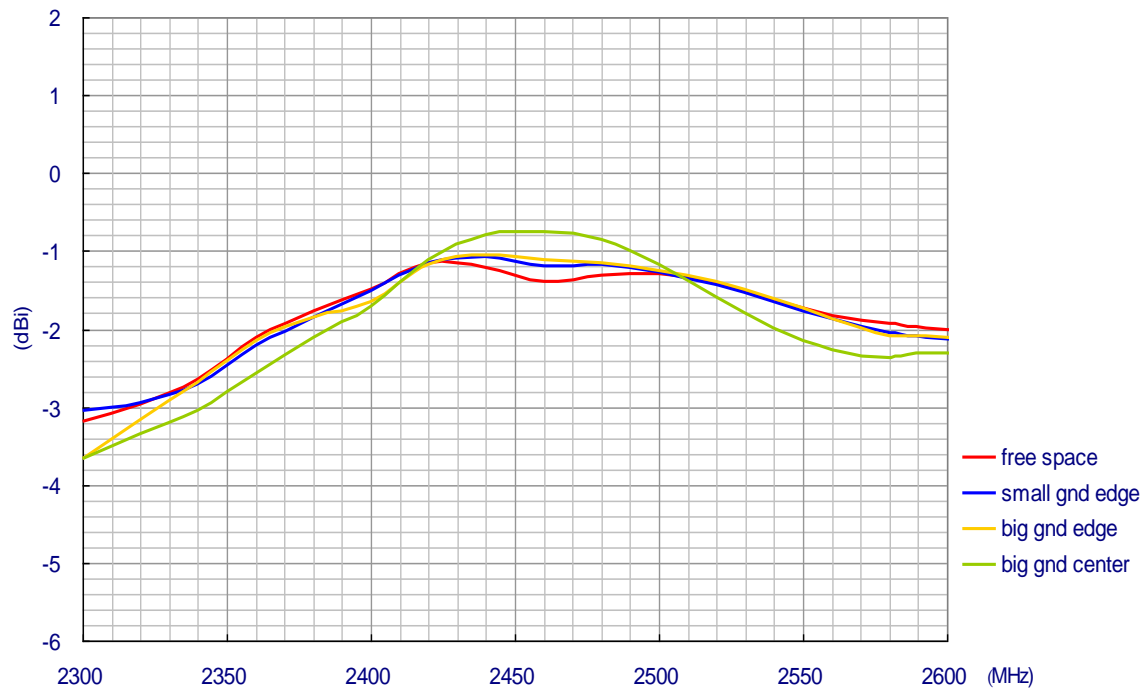

### 6.6. Average Gain of Bend GW.17

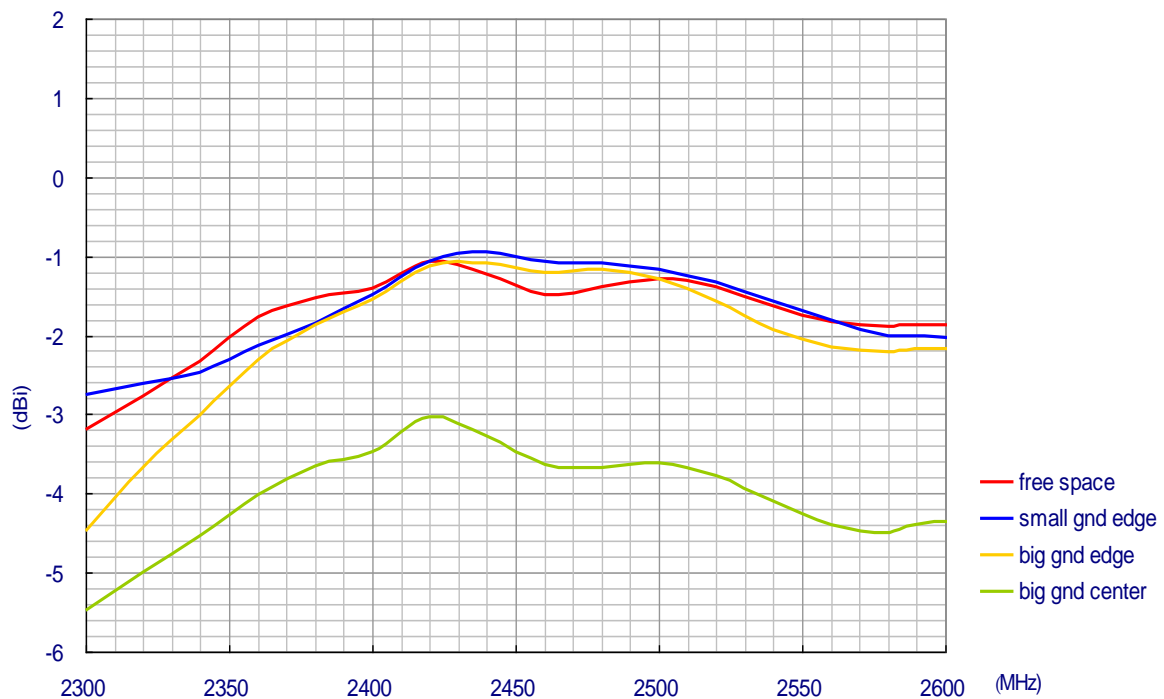

## 6.7. Radiation Pattern of Straight GW.17 at 2.40GHz E-Plane Radiation

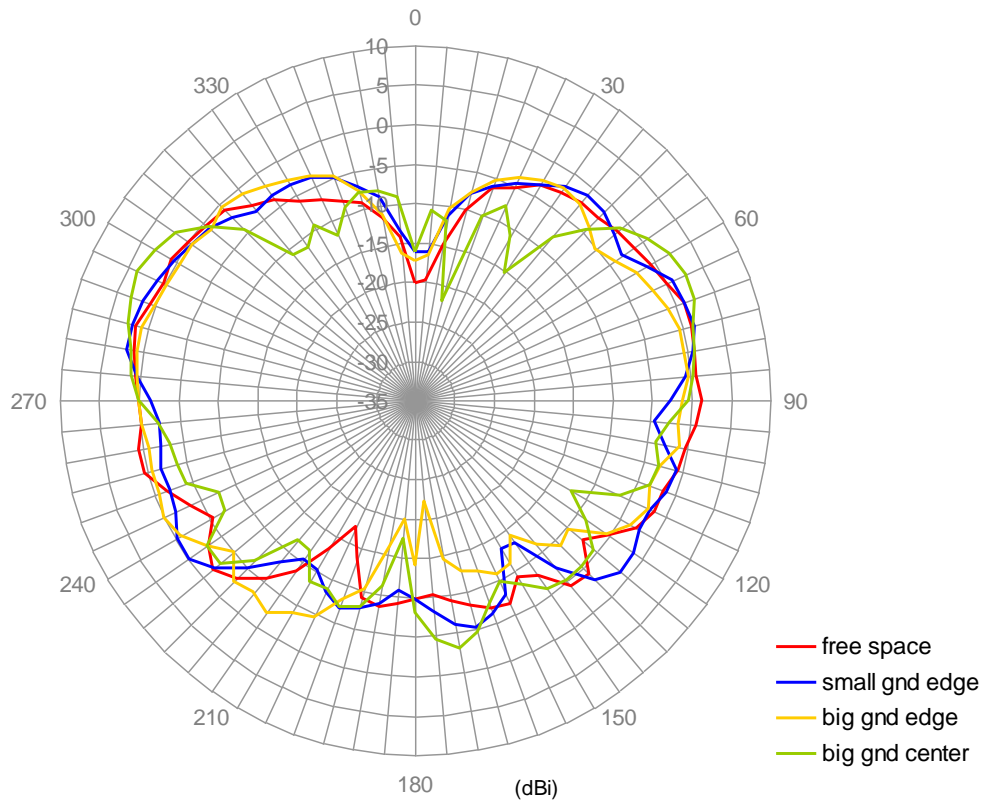

## H-Plane Radiation

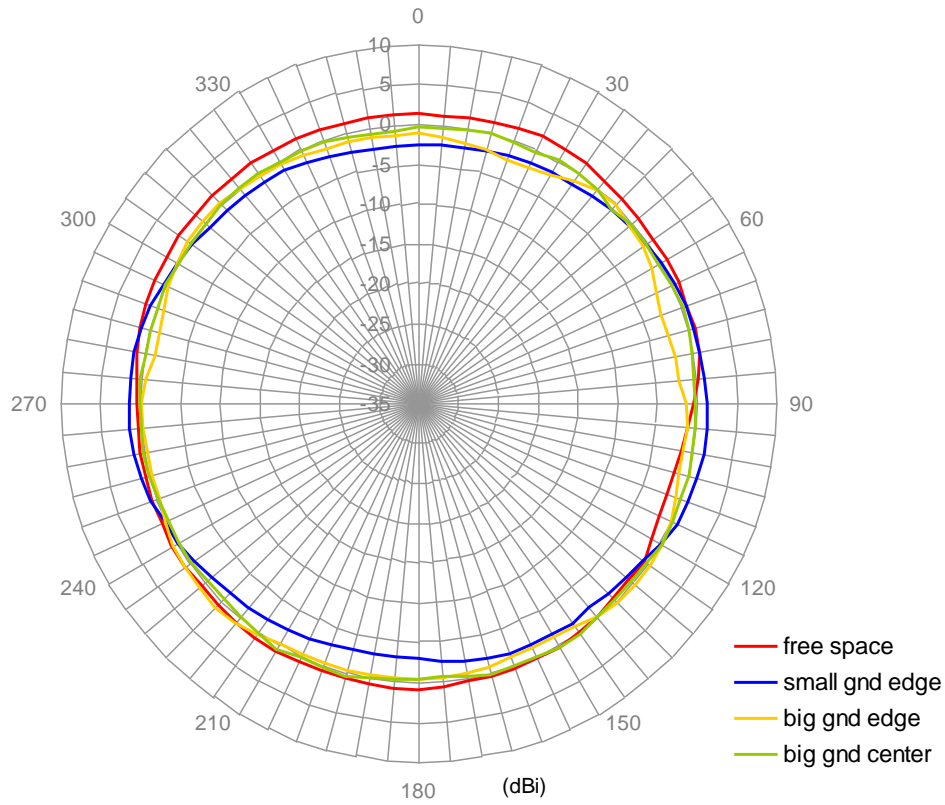



## 6.8. Radiation Pattern of Bend GW.17 at 2.40GHz

### E-Plane Radiation

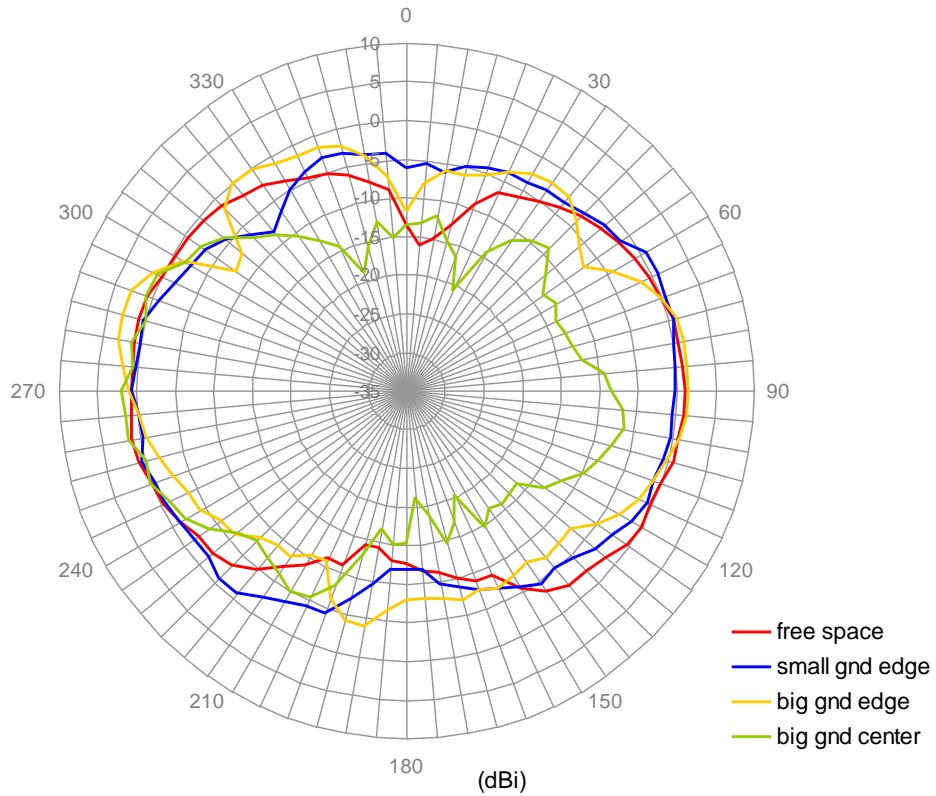

## H-Plane Radiation

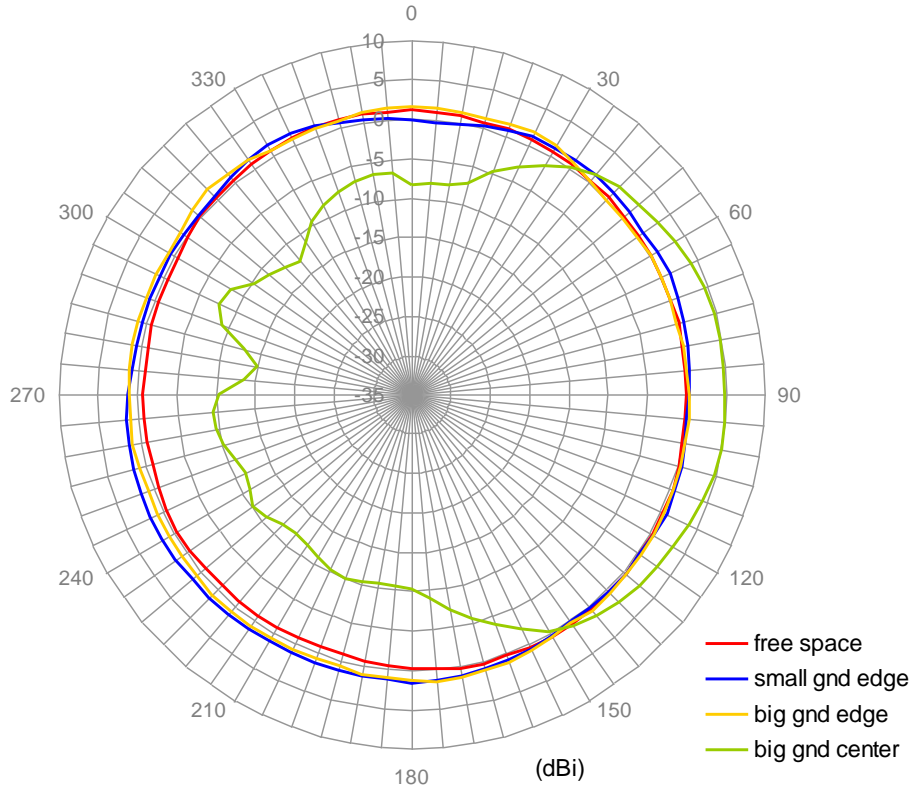

## 6.9. Radiation Pattern of Straight GW.17 at 2.45GHz E-Plane Radiation

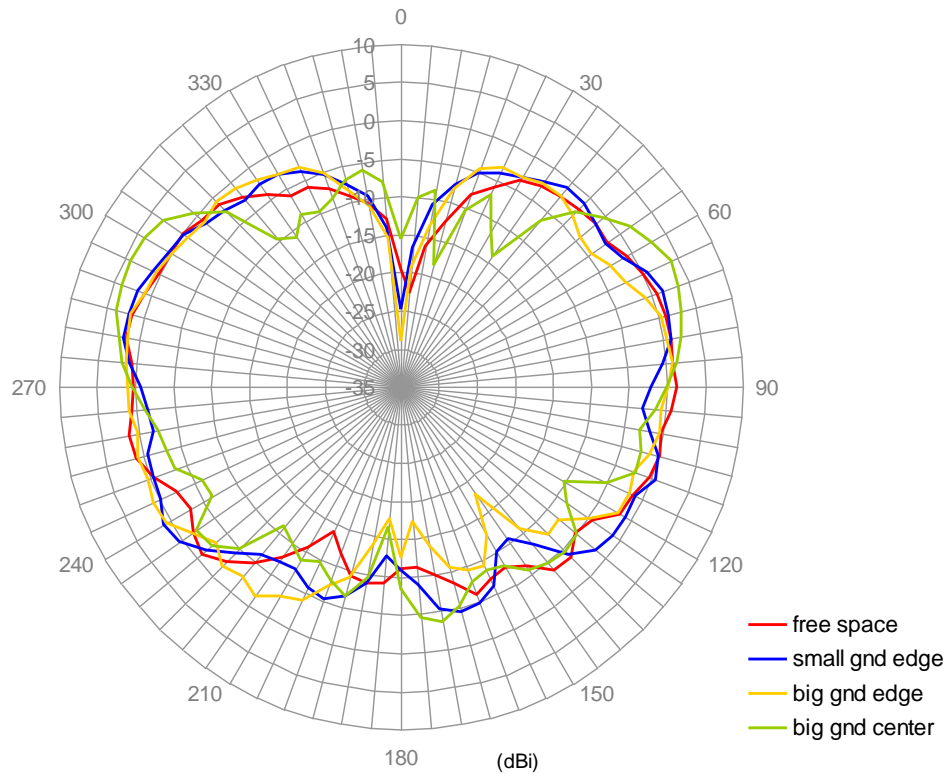

## H-Plane Radiation

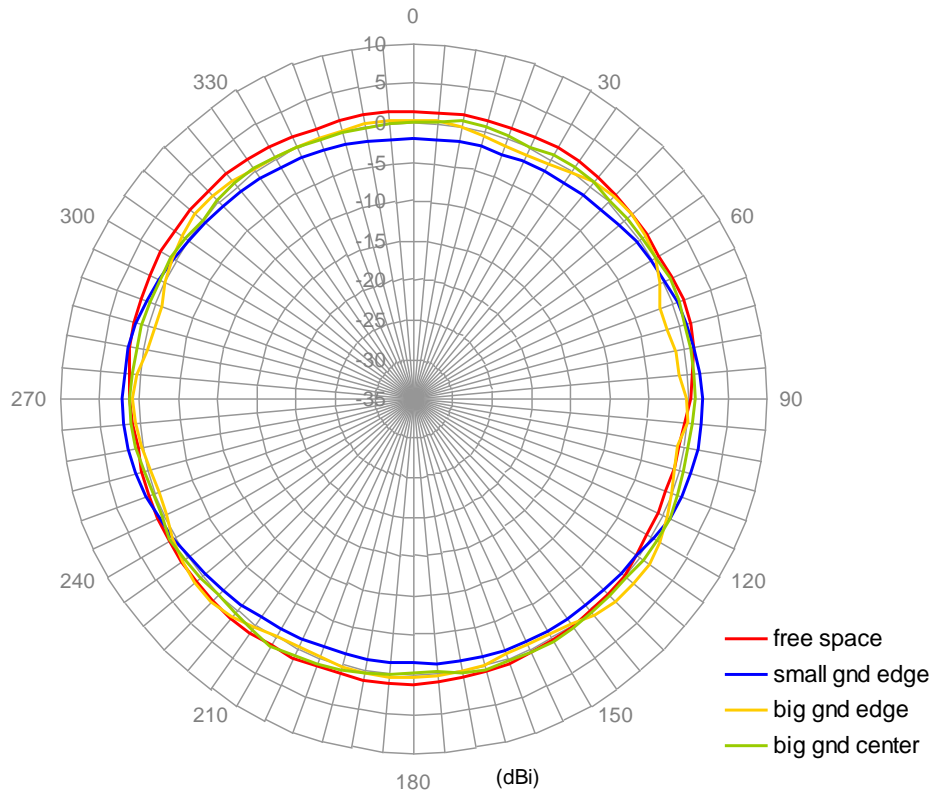

## 6.10. Radiation Pattern of Bend GW.17 at 2.45GHz E-Plane Radiation

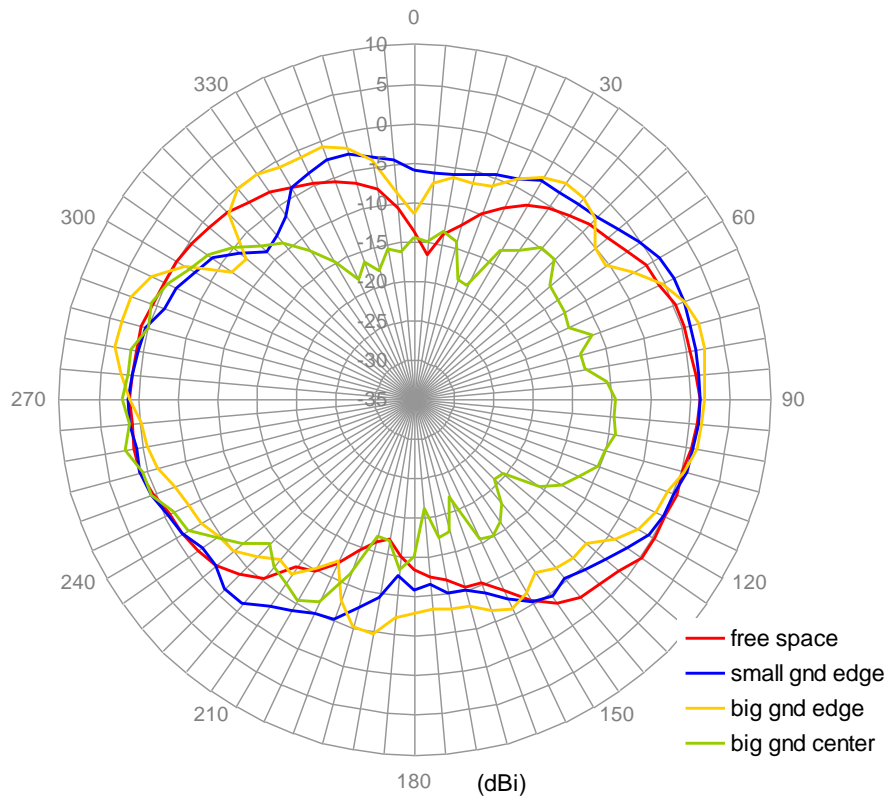

## H-Plane Radiation

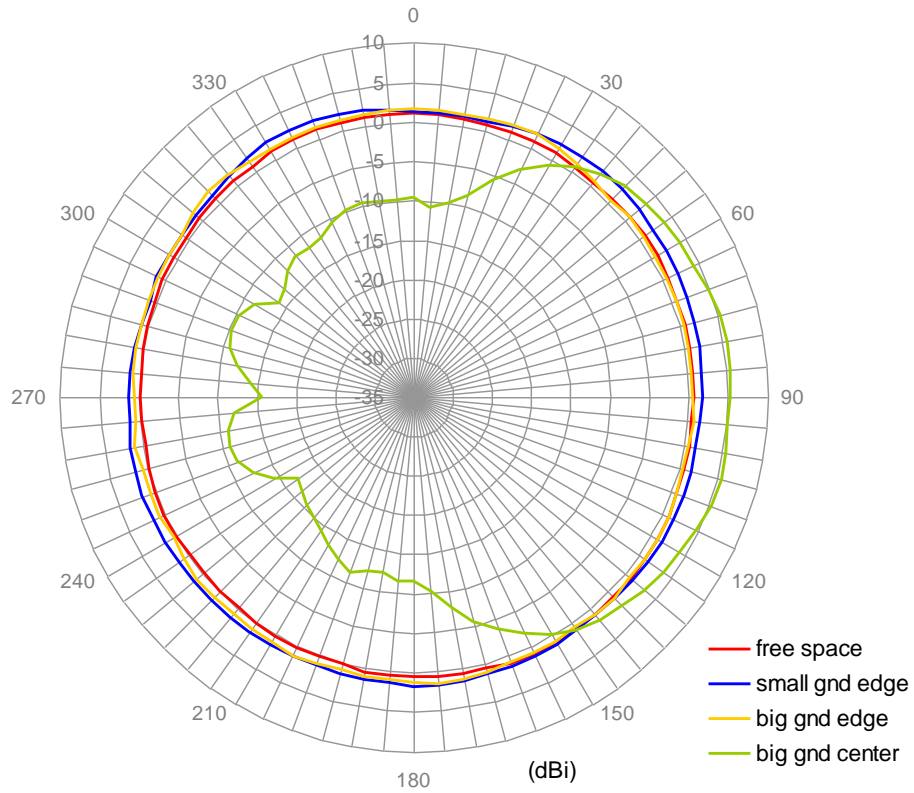

## 6.11. Radiation Pattern of Straight GW.17 at 2.50GHz E-Plane Radiation

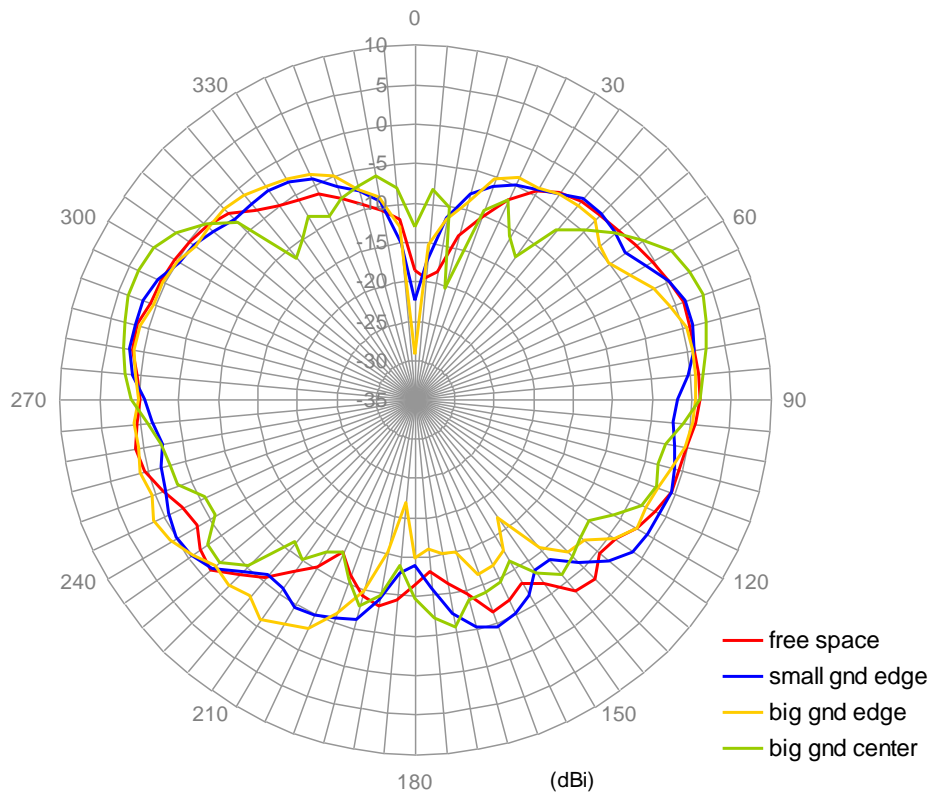

## H-Plane Radiation

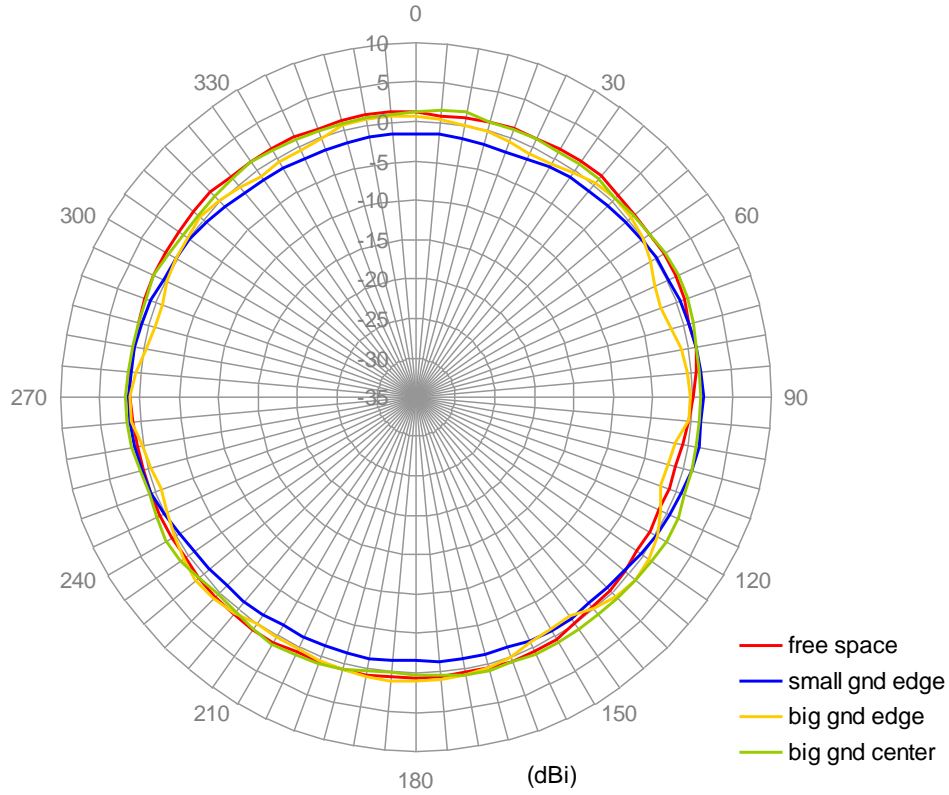



## 6.12. Radiation Pattern of Bend GW.17 at 2.50GHz

### E-Plane Radiation

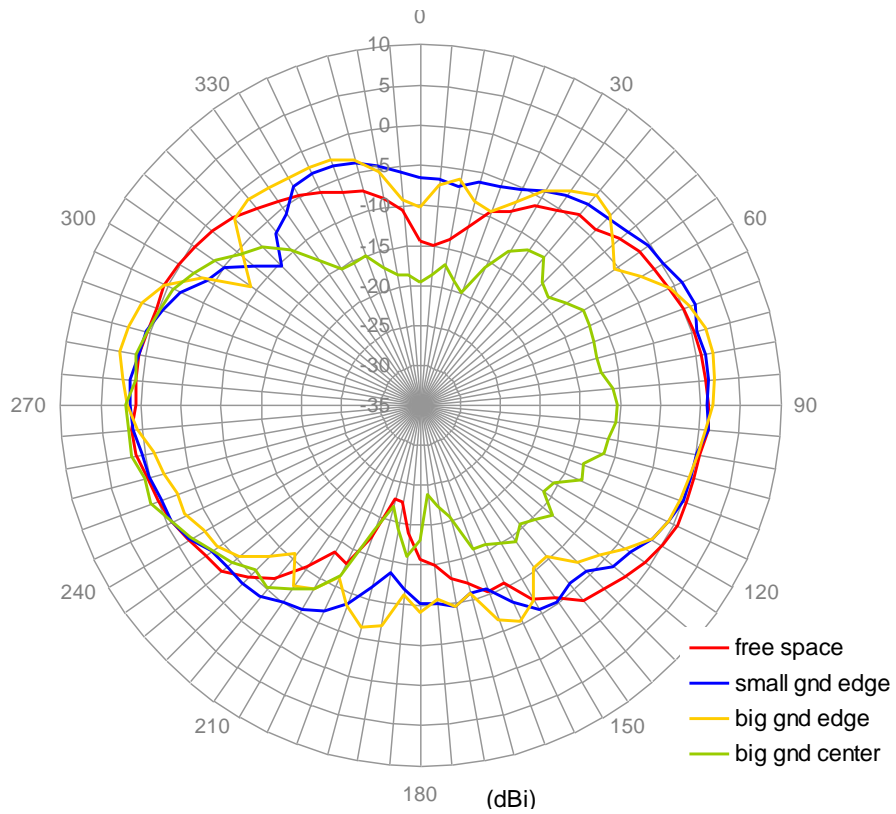

## H-Plane Radiation

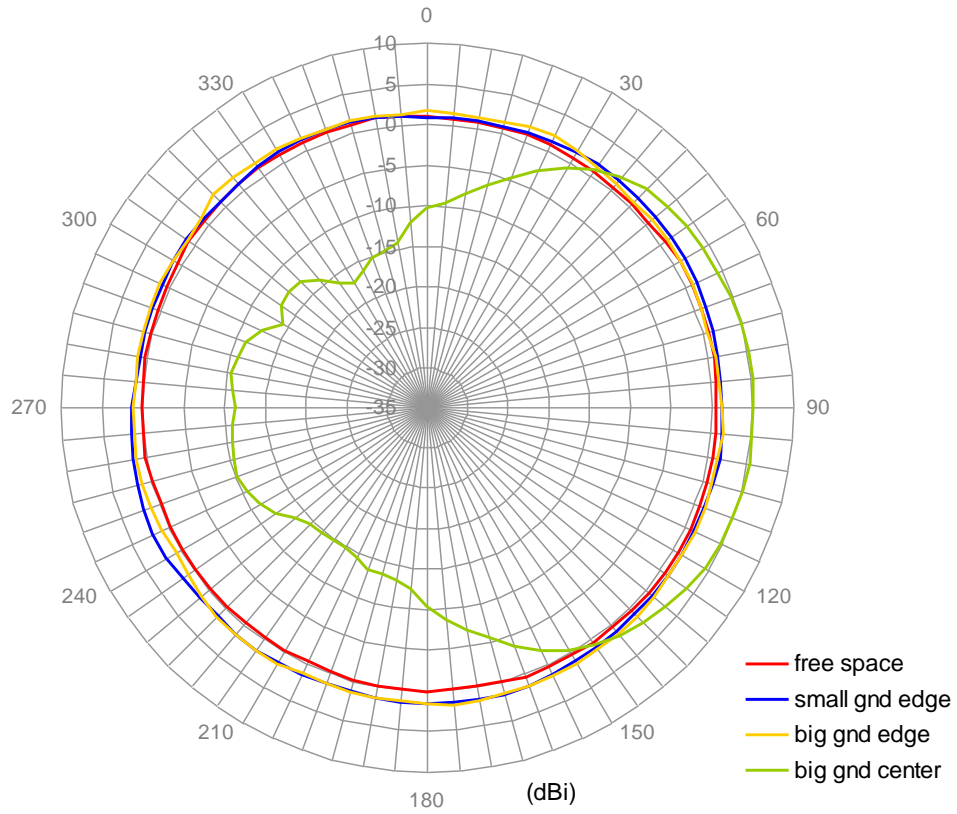

## 7. Antenna Drawing

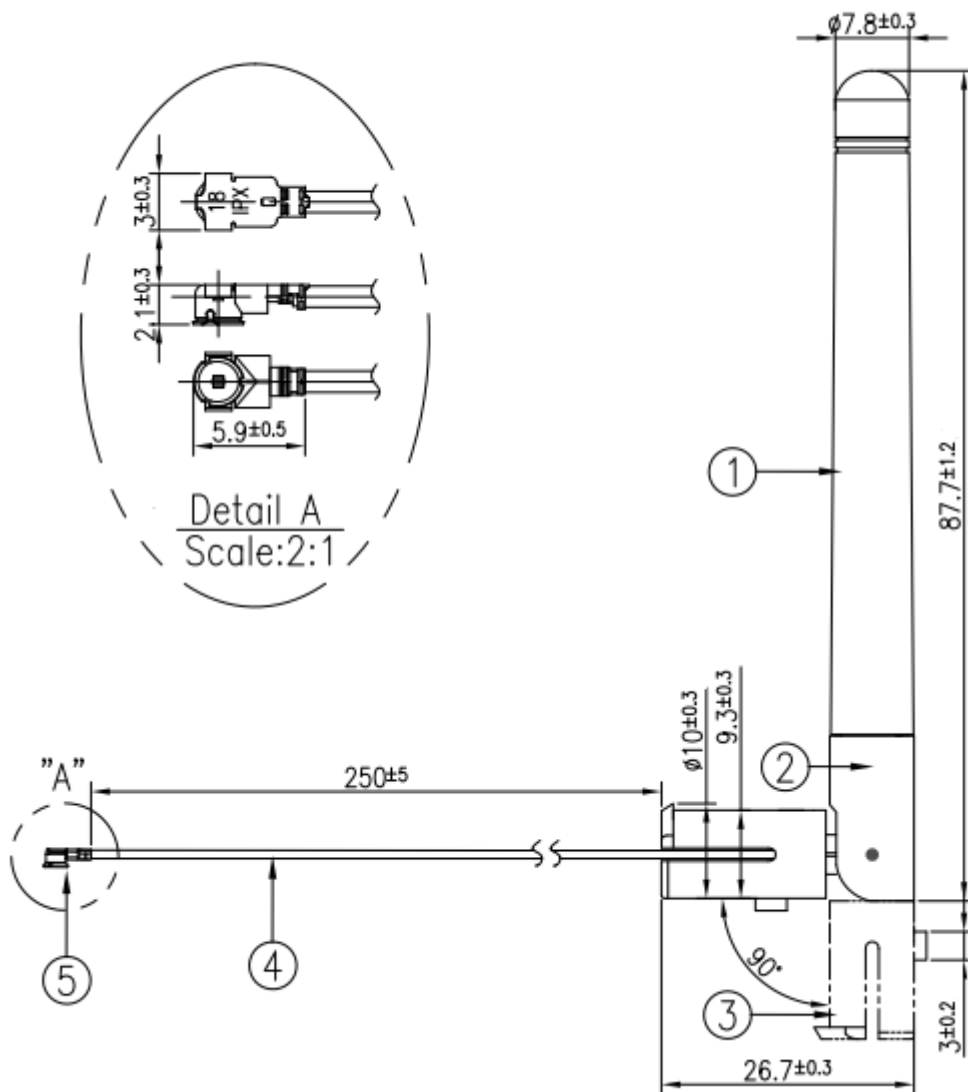

	Name	P/N	Material	Finish	QTY
1	GW17 Housing	000111J030002A	TPEE	Black	1
2	GW17 Base 1	000111J040002A	PC+PBT	Black	1
3	GW17 Base 2	000111J050002A	PC+PBT	Black	1
4	RG178 Coaxial Cable	301115C010000A	FEP	Brown	1
5	IPEX MHF1	204112E000002A	Brass	Au Plated	1

## 8. Antenna Socket Design

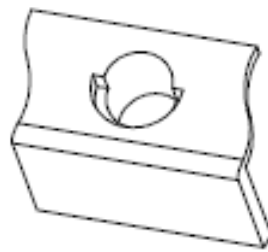

3D View

Top View

Front View

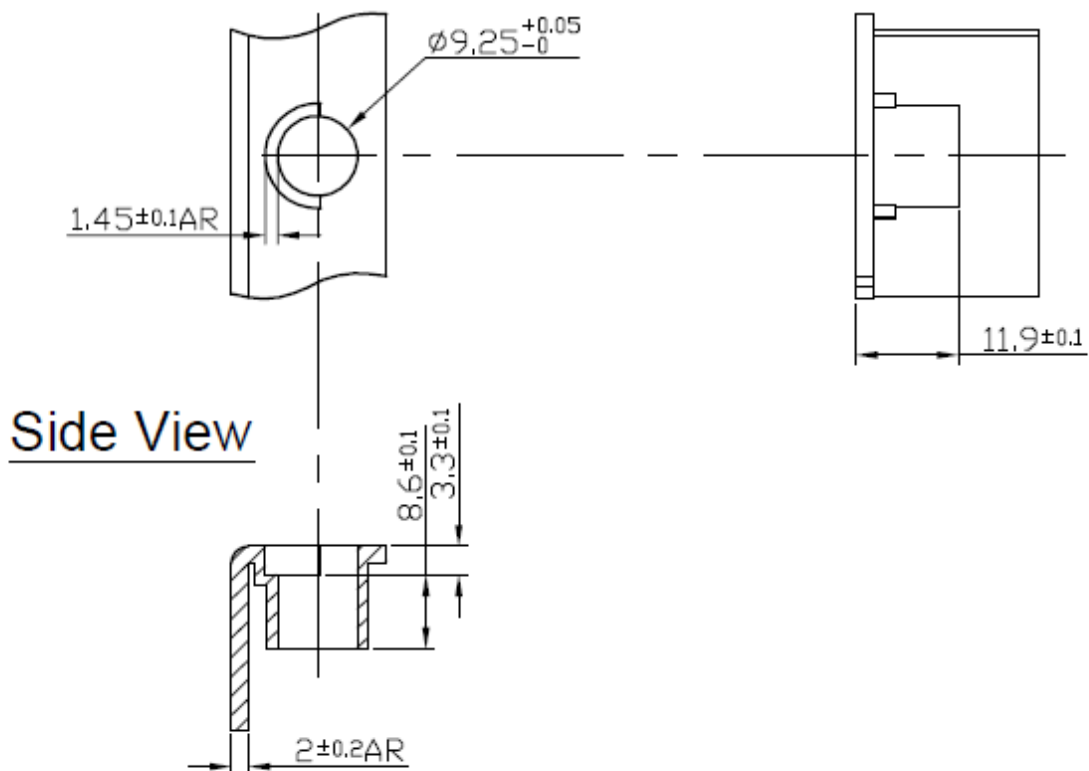

## 9. Antenna Insertion Mechanism

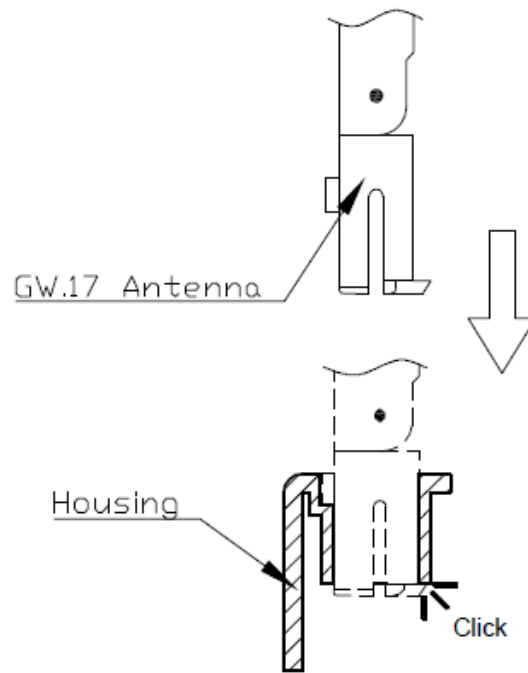

## 10. Packaging

