

### Product Summary

$V_{(BR)DSS}$	$R_{DS(on)MAX}$	$I_D@25^{\circ}C$
1200V	34mΩ@20V	90A

### Feature

- High Blocking Voltage With Low On-Resistance
- High Speed Switching With Low Capacitance
- Easy to Parallel and Simple to Drive
- Avalanche Ruggedness

### Application

- Solar Inverters
- Switch Mode Power Supplies
- High Voltage DC/DC Converters
- Motor Drivers
- Pulsed Power Applications

### Package

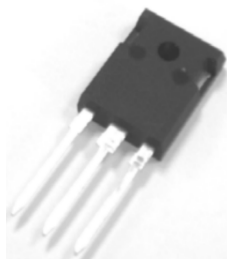

TO-247-3

### Marking



### Circuit diagram

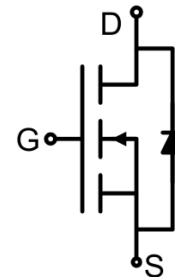

### Absolute maximum ratings ( $T_C=25^{\circ}C$ unless otherwise noted)

Parameter	Symbol	Test Condition	Value	Unit
Drain-Source Voltage	$V_{DSmax}$	$V_{GS} = 0V, I_{DS} = 100\mu A$	1200	V
Gate-Source Voltage	$V_{GSmax}$	Absolute maximum values	-10/+25	V
Gate-Source Voltage	$V_{GSOP}$	Recommended operational values	-5/+20	V
Continuous Drain Current	$I_D$	$V_{GS} = 20V, T_C = 25^{\circ}C$	90	A
	$I_D$	$V_{GS} = 20V, T_C = 100^{\circ}C$	60	A
Pulsed Drain Current	$I_{DM}$	Pulse width $t_p$ limited by $T_{jmax}$	250	A
Power Dissipation	$P_D$	$T_C = 25^{\circ}C, T_J = 150^{\circ}C$	463	W
Thermal Resistance	$R_{\theta JC}$	Junction-to-Case	0.28	$^{\circ}C/W$
Junction Temperature	$T_J$		-55 ~ +150	$^{\circ}C$
Storage Temperature	$T_{STG}$		-55 ~ +150	$^{\circ}C$

### Electrical characteristics (T<sub>c</sub>=25 °C, unless otherwise noted)

Parameter	Symbol	Test Condition	Min.	Typ.	Max.	Unit
<b>Static Characteristics</b>						
Drain-source breakdown voltage	V <sub>(BR)DSS</sub>	V <sub>GS</sub> = 0V, I <sub>DS</sub> = 100μA	1200			V
Zero gate voltage drain current	I <sub>DSS</sub>	V <sub>DS</sub> = 1200V, V <sub>GS</sub> = 0V			100	μA
Gate-Source leakage current	I <sub>GSS</sub>	V <sub>GS</sub> = 20V, V <sub>DS</sub> = 0V			250	nA
Gate threshold voltage	V <sub>GS(th)</sub>	V <sub>DS</sub> = V <sub>GS</sub> , I <sub>DS</sub> = 15mA	2.0		4.0	V
		V <sub>DS</sub> = V <sub>GS</sub> , I <sub>DS</sub> = 15mA, T <sub>J</sub> = 150°C		1.8		
Drain-source on-resistance	R <sub>DS(on)</sub>	V <sub>GS</sub> = 20V, I <sub>D</sub> = 50A		25	34	mΩ
		V <sub>GS</sub> = 20V, I <sub>D</sub> = 50A, T <sub>J</sub> = 150°C		43		
Transconductance	g <sub>fs</sub>	V <sub>DS</sub> = 20V, I <sub>D</sub> = 50A		22.8		S
		V <sub>DS</sub> = 20V, I <sub>D</sub> = 50A, T <sub>J</sub> = 150°C		21.2		
<b>Dynamic characteristics</b>						
Input Capacitance	C <sub>iss</sub>	V <sub>DS</sub> = 1000V, V <sub>GS</sub> = 0V, f = 1MHz V <sub>AC</sub> = 25mV		3600		pF
Output Capacitance	C <sub>oss</sub>			240		
Reverse Transfer Capacitance	C <sub>rss</sub>			16		
C <sub>oss</sub> Stored Energy	E <sub>oss</sub>			122		
Turn-on Switching Energy	E <sub>on</sub>	V <sub>DS</sub> = 800V, V <sub>GS</sub> = -5V/20V, I <sub>D</sub> = 30A, R <sub>g</sub> = 2.5Ω, L = 200μH		1.8		μJ
Turn-off Switching Energy	E <sub>off</sub>			1.5		
Total Gate Charge	Q <sub>g</sub>	V <sub>DS</sub> = 800V, V <sub>GS</sub> = -5V/20V, I <sub>D</sub> = 30A		195		nC
Gate-Source Charge	Q <sub>gs</sub>			54		
Gate-Drain Charge	Q <sub>gd</sub>			29		
Turn-on delay time	t <sub>d(on)</sub>	V <sub>DS</sub> = 800V, V <sub>GS</sub> = -5V/20V, I <sub>D</sub> = 30A, R <sub>g</sub> = 2.5Ω, R <sub>L</sub> = 2.5Ω		16		nS
Turn-on rise time	t <sub>r</sub>			16.2		
Turn-off delay time	t <sub>d(off)</sub>			33		
Turn-off fall time	t <sub>f</sub>			7.8		
Internal Gate Resistance	R <sub>G</sub>	f = 1MHz open drain		2.0		Ω
<b>Source-Drain Diode characteristics</b>						
Diode Forward Current	I <sub>S</sub>	T <sub>C</sub> = 25°C			90	A
Diode Forward voltage	V <sub>DS</sub>	V <sub>GS</sub> = -5V, I <sub>F</sub> = 25A		3.6		V
		V <sub>GS</sub> = -5V, I <sub>F</sub> = 25A, T <sub>J</sub> = 150°C		3.3		
Reverse Recovery Time	t <sub>rr</sub>	V <sub>GS</sub> = -5V, I <sub>SD</sub> = 25A, V <sub>R</sub> = 800V		55		nS
Reverse Recovery Charge	Q <sub>rr</sub>			320		nC
Peak Reverse Recovery Current	I <sub>rrm</sub>			10.7		A

## Typical Characteristics

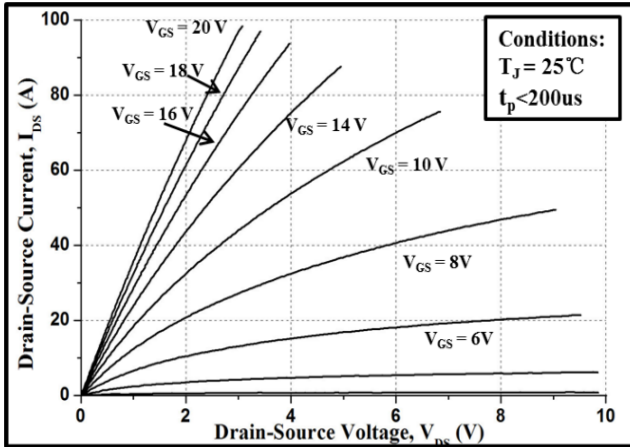

Figure 1. Typical Output Characteristics  $T_J=25^\circ\text{C}$

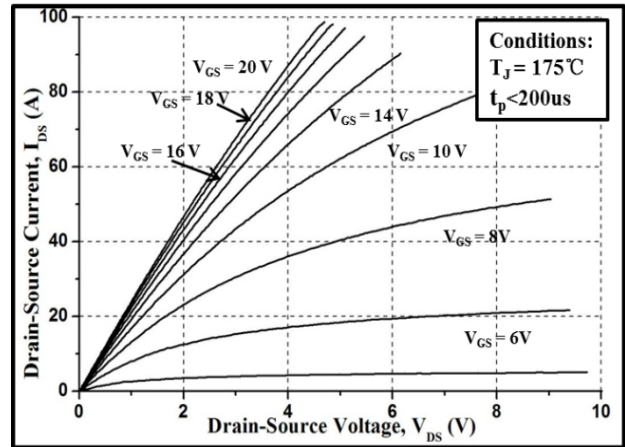

Figure 2. Typical Output Characteristics  $T_J=175^\circ\text{C}$

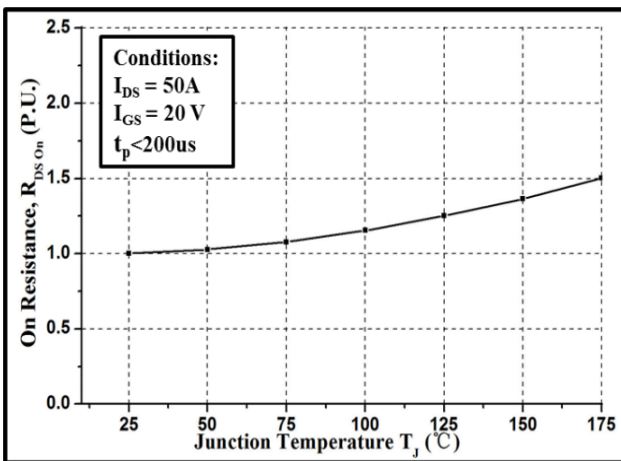

Figure 3. Normalized On-Resistance vs. Temperature

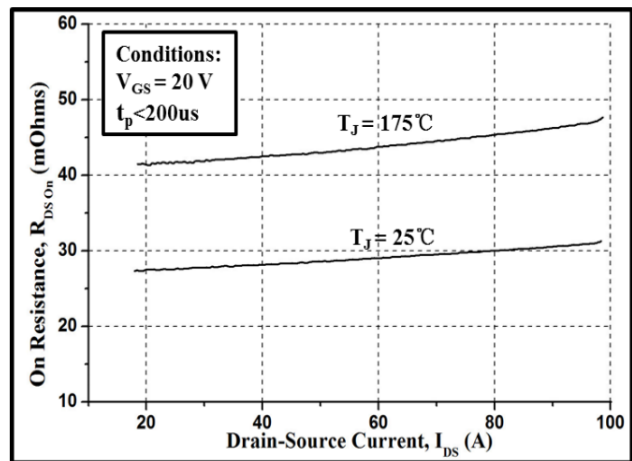

Figure 4. On-Resistance vs. Drain Current

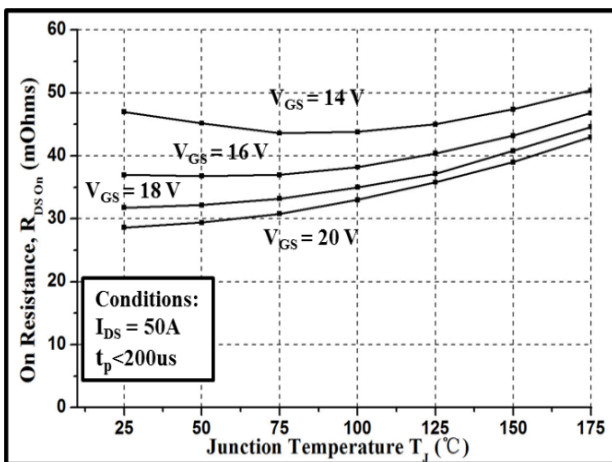

Figure 5. On-Resistance vs. Temperature

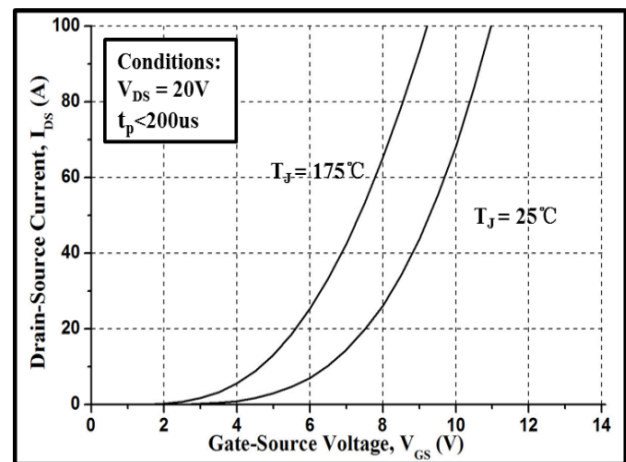

Figure 6. Typical Transfer Characteristics

## Typical Characteristics

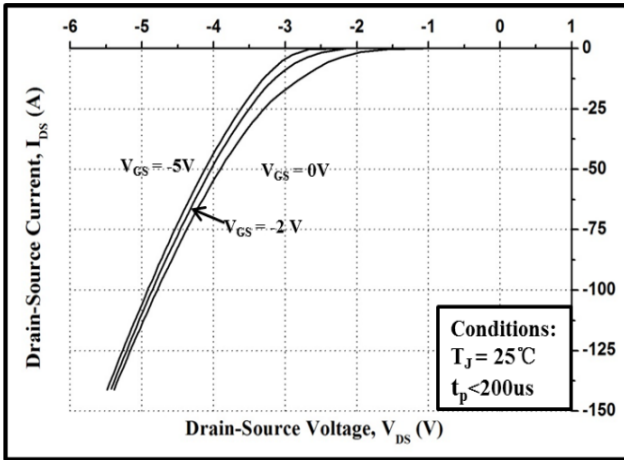

Figure 7. Body Diode Characteristics at 25°C

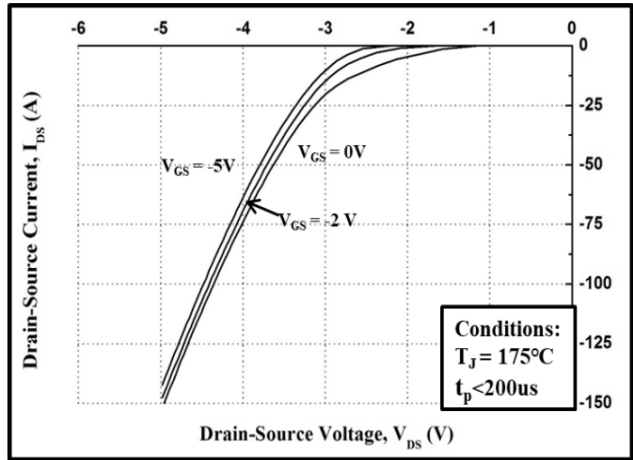

Figure 8. Body Diode Characteristics at 175°C

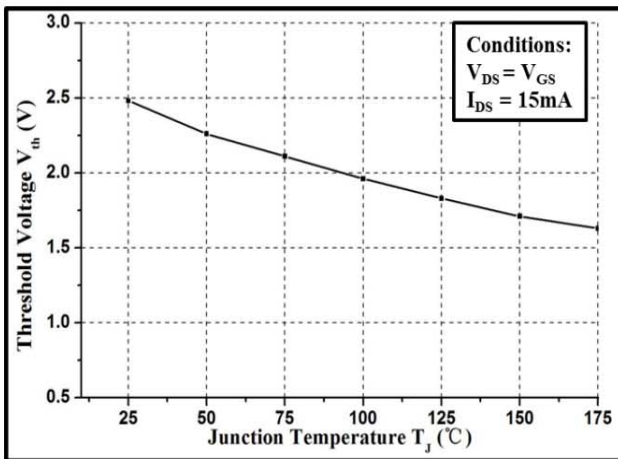

Figure 9. Gate Threshold Voltage vs. Temperature

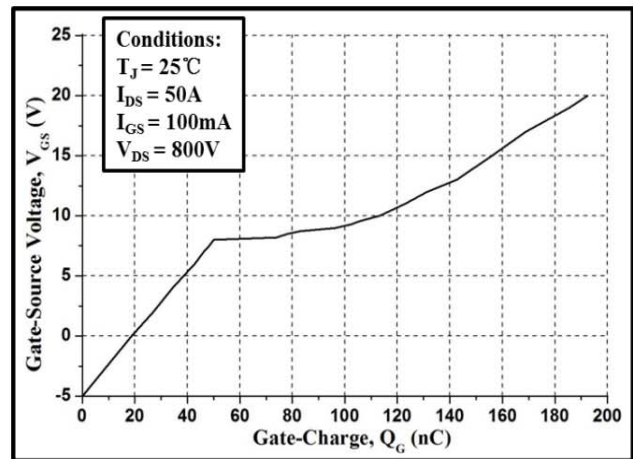

Figure 10. Gate Charge Characteristic

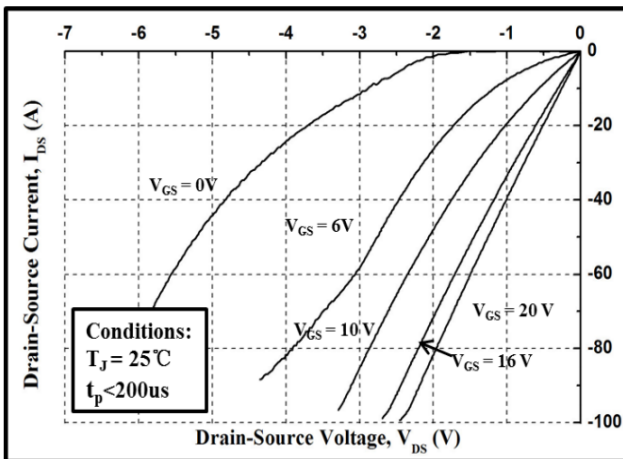

Figure 11. 3<sup>rd</sup> Quadrant Characteristics at 25° C

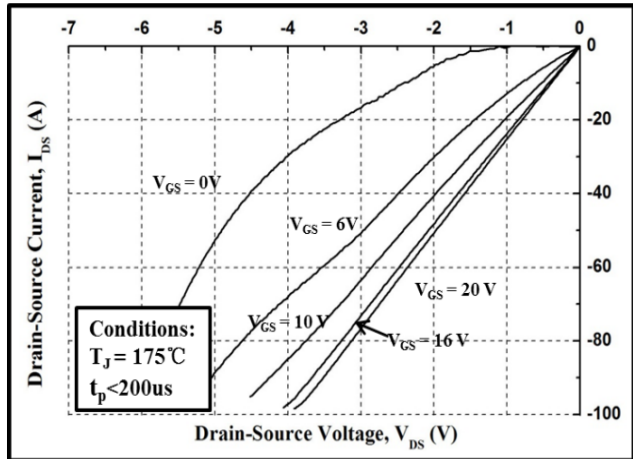

Figure 12. 3<sup>rd</sup> Quadrant Characteristics at 175° C

## Typical Characteristics

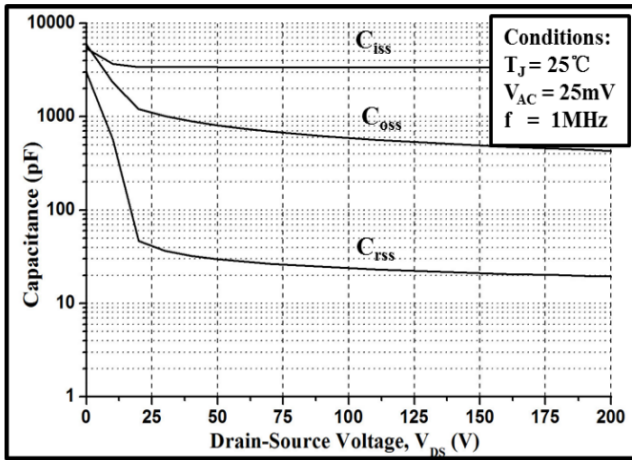

Figure 13. Capacitances vs. Drain-Source Voltage

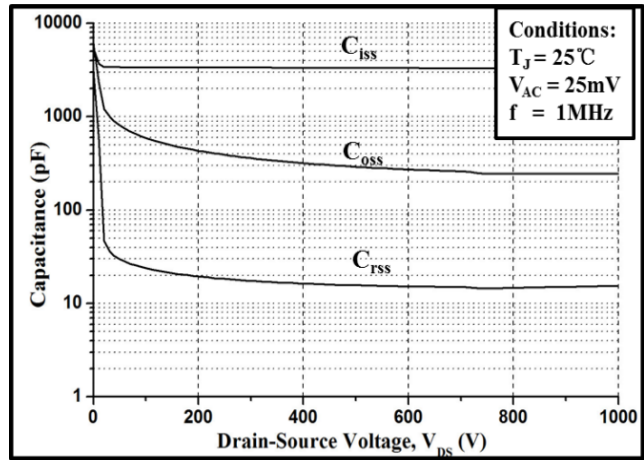

Figure 14. Capacitances vs. Drain-Source Voltage

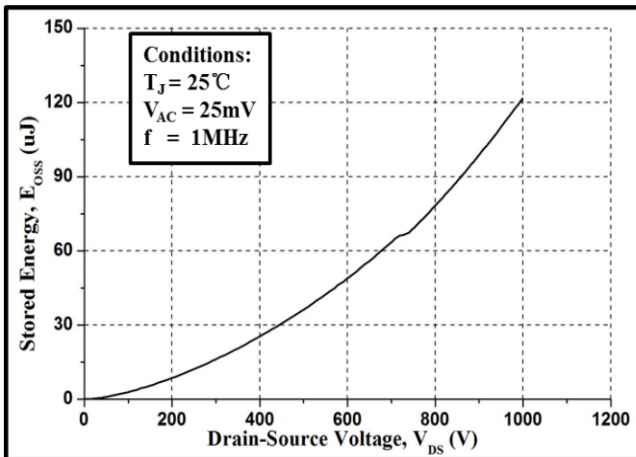
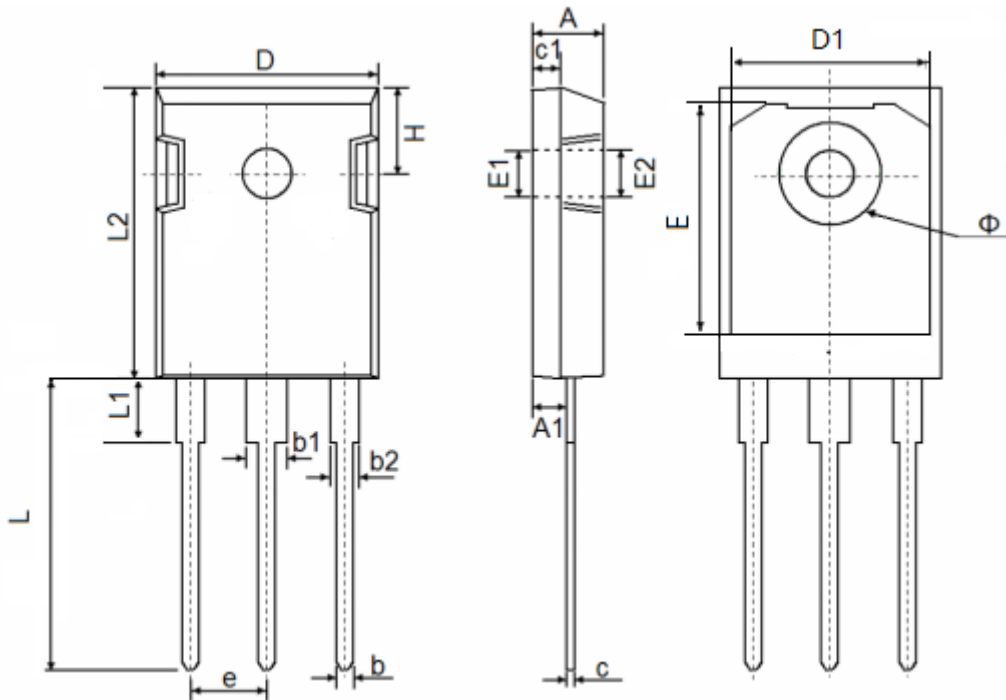

Figure 15. Output Capacitor Stored Energy

### TO-247-3 Package Information



Symbol	Dimensions In Millimeters		Dimensions In Inches	
	Min.	Max.	Min.	Max.
A	4.800	5.250	0.189	0.207
A1	2.250	2.550	0.089	0.100
b	1.050	1.350	0.041	0.053
b1	2.850	3.400	0.112	0.134
b2	1.900	2.420	0.075	0.095
c	0.550	0.700	0.022	0.028
c1	1.900	2.200	0.075	0.087
D	15.700	16.200	0.618	0.638
D1	13.000	14.200	0.512	0.559
E	16.250	17.650	0.640	0.695
E1	3.650	5.200	0.144	0.205
E2	3.650	5.200	0.144	0.205
L	19.800	20.350	0.780	0.801
L1	4.000	4.500	0.157	0.177
L2	20.800	21.200	0.819	0.835
φ	7.180 BSC		0.283 BSC	
e	5.440 BSC		0.214 BSC	
H	6.000	6.300	0.236	0.248