

**Style**

M12 Socket  
6 pin  
A-coding

**Ratings**

Voltage: 30 V  
Current: 2 A

**Operating Temperature Range**

-40 ~ 105 °C

**Materials**

- ① Insulator: Polyamide 66 (PA66), UL94 HB, black
- ② Pin: C3604 brass, gold plated
- ③ Shell: C3604 brass, nickel plated
- ④ O-ring: Nitrile rubber, green

**Electrical Requirements**

Dielectric strength: 1 min @ 500 Vac  
Insulation resistance: 100 MΩ @ 500 Vdc  
Contact resistance: 10 mΩ or less

**Mechanical Requirements**

Life cycle: 500 mating cycles minimum

**Environmental Requirements**

Salt spray test: 35 °C, relative humidity 90-95%, 5% NaCl mist for 48 hrs. Wash parts after test. Maintain mechanical requirements and a contact resistance of less than 10 mΩ.  
Waterproof: IP67

**Assembly Info**

Wire gauge: 24 AWG max

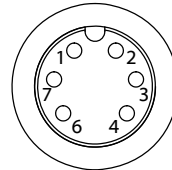

Front View  
Not to Scale

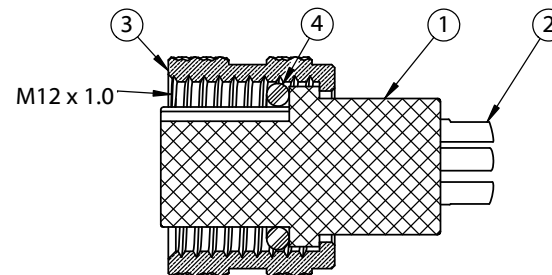
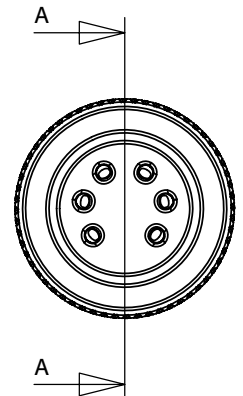
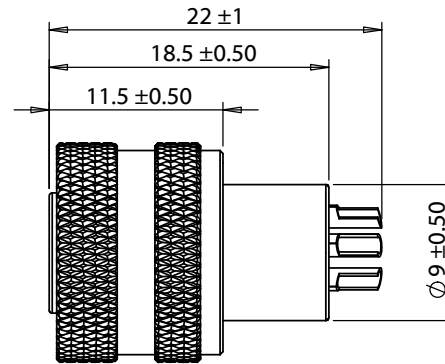
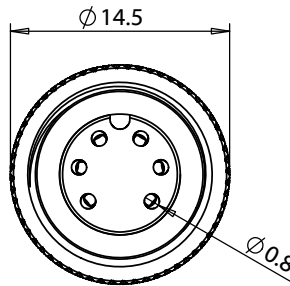

SECTION A-A

Revision:	Date:	Description:	Prepared:	Notes:	<b>TENSILITY</b> tel 1.541.323.3228 800 877.670.7118 fax 1.541.323.4202 web tensility.com
A	8/3/2020	Initial release	Verified:	RoHS compliant Function test: no open, no short circuit, no intermittent	
			Dimensions are in millimeters. Tolerances: X: ± 0.3 mm X.X: ± 0.1 mm X.XX: ± 0.05 mm	Description: Connector, 6 pin M12 A-code socket, 12xL22mm, gold plated, molding style, solder cup, IP67	Size: Part number: A 50-00954
					Scale: 2:1  Sheet 1 of 1