

Si4836 DEMO BOARD USER'S GUIDE

1. Features

- ATAD (analog tune and analog display) AM/FM/SW radio
- Worldwide FM band support from 64–109 MHz with 5 bands, see Table 1
- Worldwide AM band support from 504–1750 kHz with 5 bands, see Table 1
- Worldwide SW band support 2.3–28.5 MHz with 18 wide bands or 18 narrow bands, see Table 1
- Twelve positions band switch for selecting different band according to the target market
- Two AAA battery operations with working voltage down to 2.0 V
- Economical potentiometer for frequency tuning replaces more expensive variable capacitor (PVC)
- Potentiometer volume control
- Push button Bass/Treble control
- FM 50 μ s or 75 μ s de-emphasis
- SW Wideband/Narrow-band selection via a slide switch

Table 1. Si4836 Band Sequence Definition

Band Name	Band Frequency Range	De-emphasis (FM) Channel Space (AM)	Note
FM1	87–108 MHz	50 μ s	
FM2	87–108 MHz	50 μ s	
FM3	87–108 MHz	75 μ s	Demo Board Default
FM4	87–108 MHz	75 μ s	
FM5	86.5–109 MHz	50 μ s	
FM6	86.5–109 MHz	50 μ s	
FM7	87.3–108.25 MHz	50 μ s	
FM8	87.3–108.25 MHz	50 μ s	
FM9	87.3–108.25 MHz	75 μ s	
FM10	87.3–108.25 MHz	75 μ s	
FM11	76–90 MHz	50 μ s	
FM12	76–90 MHz	50 μ s	
FM13	64–87 MHz	50 μ s	
FM14	64–87 MHz	50 μ s	
FM15	76–108 MHz	50 μ s	
FM16	76–108 MHz	50 μ s	
FM17	64–108 MHz	50 μ s	Demo Board Default
FM18	64–108 MHz	50 μ s	
AM1	520–1710 kHz	10k	Demo Board Default

Si4836-DEMO

Table 1. Si4836 Band Sequence Definition

Band Name	Band Frequency Range		De-emphasis (FM) Channel Space (AM)	Note
AM2	522–1620 kHz		9k	Demo Board Default
AM3	504–1665 kHz		9k	
AM4	522–1728 kHz / 520–1730 kHz		9k / 10k	
AM5	510–1750 kHz		10k	
SW1	SW Wide Band	SW Narrow Band		
	2.3–10.0 MHz	2.30–2.49 MHz		
SW2	3.2–7.6 MHz	3.20–3.40 MHz		Demo Board Default
SW3	3.2–10.0 MHz	3.90–4.00 MHz		Demo Board Default
SW4	3.7–12.5 MHz	4.75–5.06 MHz		
SW5	3.9–7.5 MHz	5.6–6.4 MHz		
SW6	5.6–22 MHz	5.95–6.2 MHz		
SW7	5.8–12.1 MHz	6.8–7.6 MHz		
SW8	5.9–9.50 MHz	7.1–7.6 MHz		
SW9	5.9–18.0 MHz	9.2–10 MHz		Demo Board Default
SW10	7.0–16.0 MHz	11.45–12.25 MHz		Demo Board Default
SW11	7.0–23.0 MHz	11.6 –12.2 MHz		Demo Board Default
SW12	9.0–16.0 MHz	13.4–14.2 MHz		
SW13	9.0–22.0 MHz	13.57–13.87 MHz		Demo Board Default
SW14	9.5–18.0 MHz	15–15.9 MHz		Demo Board Default
SW15	10.0–16.0 MHz	17.1–18 MHz		
SW16	10.0–22.0 MHz	17.48–17.9 MHz		Demo Board Default
SW17	13.0–18.0 MHz	21.2–22 MHz		
SW18	18.0–28.5 MHz	21.45 –21.85 MHz		

2. Overview

This user's guide describes the operation of the Silicon Labs Si4836-DEMO board rev1.1, Nov 20, 2012. The Silicon Laboratories Si4836-DEMO board is designed with the 16-pin SOIC packaged Si4836 chip, the revolutionary single chip AM/FM/SW receiver that integrates everything from antenna input to audio output and allows use of common and economical potentiometers to do the frequency tuning. It provides a complete portable analog tune analog display AM/FM/SW radio design. The Si4836-DEMO is designed with 1-layer PCB, allowing the lowest cost without sacrificing the RF performance. The demo board works with two AAA batteries and working voltage down to 2.0 V.

3. Description

Figure 1 and Figure 2 shows the physical layout of the board with key components indicated.

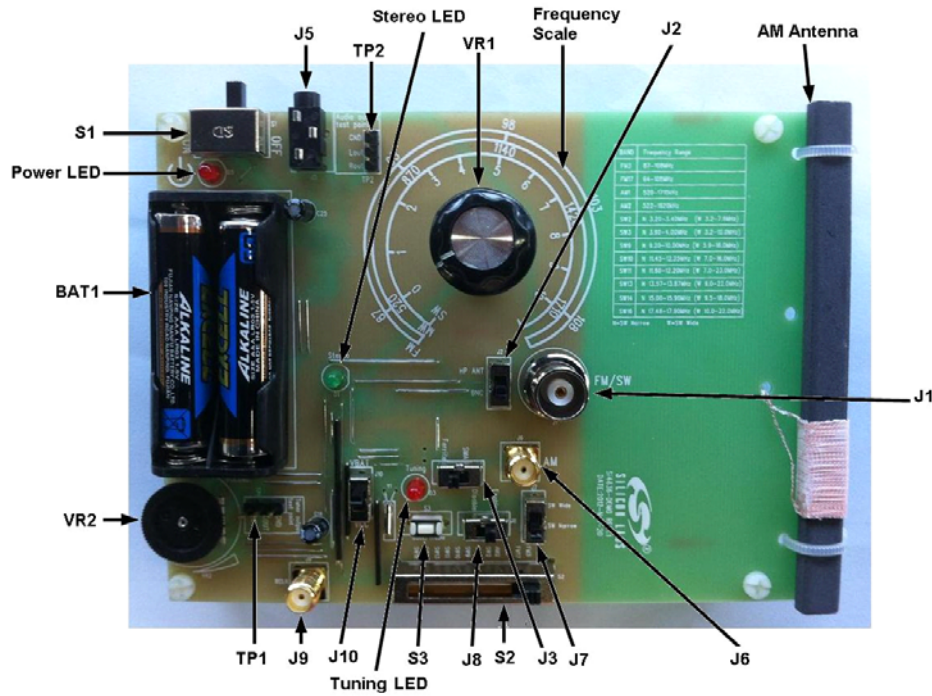

Figure 1. Si4836-DEMO Board Top Side

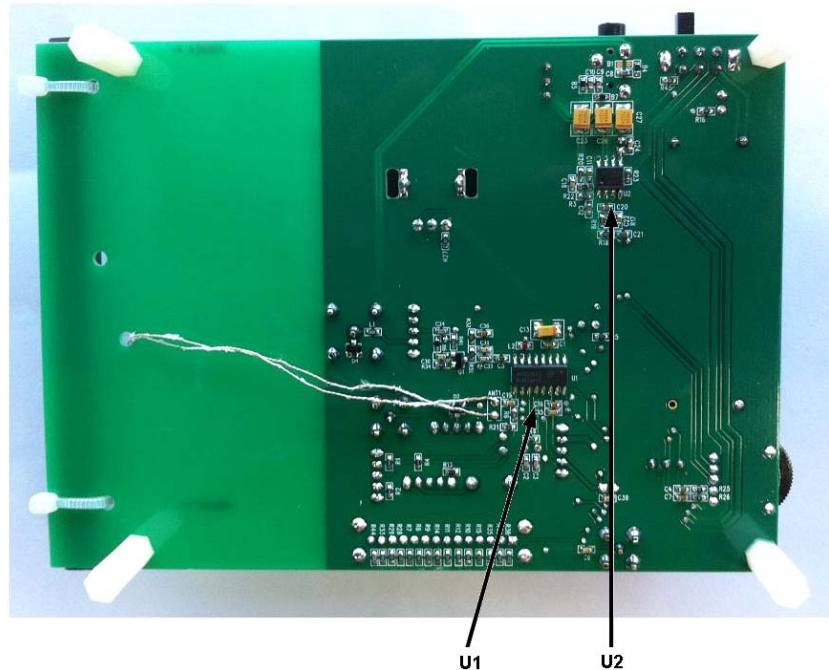

Figure 2. Si4836-DEMO Board Bottom Side

Si4836-DEMO

Power:

BAT1: 2 cells AAA battery holder

S1: Power on / off

Audio Connectors:

J5: Stereo audio headphone output

Antenna Selections:

AM antenna: Ferrite stick antenna for AM

J1: BNC connector for FM/ SW conductive testing or FM whip antenna

J2: FM antenna selector

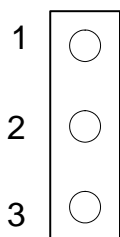

1-2: HP ANT (J5)

2-3: BNC (J1)

J6: SMA connector for AM conductive testing

J3: AM antenna selector

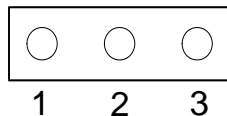

1-2: AM Ferrite Antenna

2-3: SMA (J6)

Audio Output Test Point:

For the general specification test, TP2 is the recommended audio signal test point. The audio test instrument should be connected to TP2 to get more accurate test results. J5 can also be used as an audio test point, but the test results may not be entirely accurate under some circumstances.

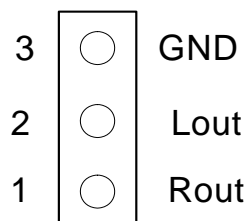

Tuner Output Test Point:

For the tuner specification test, TP1 is the recommended tuner output test point. The audio test instrument should be connected to TP1 to get accurate test results.

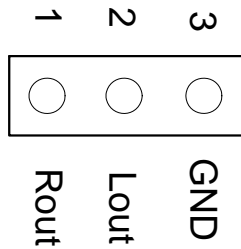

Main Components:

U1: Silicon Laboratories Si4836 AM/FM/SW ATAD receiver

U2: Audio amplifier

Frequency scale: The analog display for tuning frequency

Control Interface:

VR1: Frequency tuning wheel.

VR2: Volume control wheel

J9: SMA connector for external RCLK

S3: The push button for bass/treble control

J8: The bass/treble function enable/disable selector

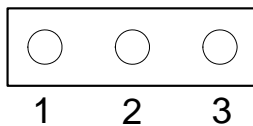

1-2: Disable

2-3: Enable

J7: SW Wideband/Narrow-band selector

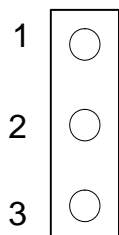

1-2: SW Wideband

2-3: SW Narrow-band

Si4836-DEMO

J10: Tuner VDD connector (connect tuner Pin14 VDD to VBAT or VCC)

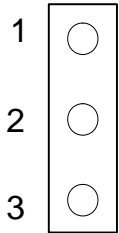

1-2: VBAT
2-3: VCC

S2: Band switch for FM, AM, and SW

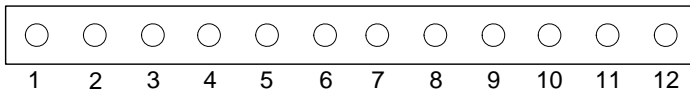

- 1: FM3 (87–108 MHz)
- 2: FM17 (64–108 MHz)
- 3: AM1 (520–1710 kHz)
- 4: AM2 (522–1620 kHz)
- 5: SW2 (N 3.2–3.4 MHz) (W 3.2–7.6 MHz)
- 6: SW3 (N 3.9–4.0 MHz) (W 3.2–10.0 MHz)
- 7: SW9 (N 9.2–10.0 MHz) (W 5.9–18.0 MHz)
- 8: SW10 (N 11.45–12.25 MHz) (W 7.0–16.0 MHz)
- 9: SW11 (N 11.6 –12.2 MHz) (W 7.0–23.0 MHz)
- 10: SW13 (N 13.57–13.87 MHz) (W 9.0–22.0 MHz)
- 11: SW14 (N 15.0–15.9 MHz) (W 9.5–18.0 MHz)
- 12: SW16 (N 17.48 –17.9 MHz) (W 10.0–22.0 MHz)

Note: N = SW Narrow-band, W = SW Wideband

4. Operation

S4836-DEMO board, a complete analog tune and analog display radio, is very easy to operate:

1. Switch the SW Wideband/Narrow-band selector J7 to the desired SW Wideband or Narrow-band.
2. Switch the tuner VDD connector J10 to the desired VABT or VCC.
3. Switch the bass/treble function enable/disable selector J8 to the desired Disable or Enable.
4. Put two AAA batteries into the battery compartment.
5. Switch the power switch S1 to the ON position. The board will power up to a radio band according to the position of the band switch.
6. Change the band switch S2 to the desired band.
7. Rotate the tuning wheel VR1 and find the desired frequency.
8. Rotate the volume control wheel VR2 to get a comfortable volume.

Note: For FM listening, the earphone cable must be connected to the board when J2 is set to "HP ANT" or an external antenna must be connected to the BNC connector when J2 is set to "BNC".

For AM listening, the ferrite antenna must be connected to the board and the J3 is set to "Ferrite" before Turning on the radio or band switching to AM.

Si4836-DEMO

5. Bill of Materials

- ATAD AM/FM/SW receiver IC Si4836 with external 32.768 kHz crystal oscillator support
- LM4910 Audio amplifier IC
- See Table 2 for details

Table 2. Si4836-DEMO Board rev1.1 Bill of Materials

Item	Qty	Reference	Description	Value
1	6	C1 C6 C16 C19 C24 C39	CAP,SM,0603,X7R	0.1 μ
2	3	C23 C26 C27	CAP,SM,1210,X7R	220 μ
3	1	C13	CAP,SM,1210,X7R	47 μ
4	2	C14 C25	Electrolytic capacitor	100 μ /4 V
5	2	C2 C3	CAP,SM,0603,X7R	22p
6	2	C30 C31	CAP,SM,0603,X7R	33n
7	1	C33	CAP,SM,0603,X7R	10p
8	1	C34	CAP,SM,0603,X7R	33p
9	4	C4 C7 C12 C21	CAP,SM,0603,X7R	10u
10	1	C15	CAP,SM,0603,X7R	4.7 μ
11	2	C5 C36	CAP,SM,0603,X7R	0.47 μ
12	2	C8 C10	CAP,SM,0603,X7R	100p
13	2	C11 C20	CAP,SM,0603,X7R	150p
14	2	C18 C22	CAP,SM,0603,X7R	330p
15	2	R25 R26	RES,SM,0603	0R
16	2	R17 R22	RES,SM,0603	12k
17	1	R27	RES,SM,0603	100R
18	1	R31	RES,SM,0603	1k
19	1	R32	RES,SM,0603	10R
20	1	R41	RES,SM,0603	120k
21	2	R3 R18	RES,SM,0603	2.2k
22	4	R5 R16 R21 R45	RES,SM,0603	200R
23	3	R6 R23 R34	RES,SM,0603	100k
24	2	R19 R20	RES,SM,0603	6.8k
25	4	R1 R2 R4 R13	RES,SM,0603	56k
26	1	R46	RES,SM,0603	4.7M
27	1	R36	RES,SM,0603,Tolerance \pm 1%	33k
28	1	R29	RES,SM,0603,Tolerance \pm 1%	140k
29	1	R43	RES,SM,0603,Tolerance \pm 1%	40k

Table 2. Si4836-DEMO Board rev1.1 Bill of Materials (Continued)

Item	Qty	Reference	Description	Value
30	1	R44	RES,SM,0603,Tolerance $\pm 1\%$	47k
31	5	R7 R9 R11 R12 R15	RES,SM,0603,Tolerance $\pm 1\%$	10k
32	1	R8	RES,SM,0603,Tolerance $\pm 1\%$	50k
33	4	R10 R28 R33 R35	RES,SM,0603,Tolerance $\pm 1\%$	20k
34	1	R14	RES,SM,0603,Tolerance $\pm 1\%$	60k
35	1	L1	RES,SM,0603	0R
36	1	L2	Inductor 270nH	270 nH
37	4	B4 B5 B6 B7	FERRITE BEAD,SM,0603	2.5k/100M
38	1	B1	FERRITE BEAD,SM,0603	NP
39	1	VR1	100k, $\pm 10\%$,Variable resistor(POT)	100k
40	1	VR2	10k, $\pm 20\%$,Variable resistor(POT)	10k
41	1	U1	Si4836,SOIC16	Si4836
42	1	U2	LM4910MA,SO8	LM4910MA
43	3	D1 D3 D5	LED	LED
44	2	D2 D4	DIODE,SM,ESD,SOT23	BAV99
45	1	Q1	TRANSISTOR NPN SOT23	2SC9018
46	1	Y1	CRYSTAL	32.768 kHz
47	1	J1	BNC VERTICAL	BNC For FM/SW testing
48	2	J6 J9	SMA VERTICAL	
49	5	J2 J3 J7 J8 J10	Single pole two throw switch	
50	1	J5	earphone jack	
51	1	S1	Two pole two throw switch	
52	1	S2	Single pole twelve throw switch	
53	1	S3	Push button	
54	1	ANT1	AW ferrite stick antenna	220 μ H
55	1	BAT1	BATTERY BOX,AAA*2 SIZE	
56	2	TP1 TP2	CONN,TH,1x3,HDR	CONN,TH,1x3,HDR

Si4836-DEMO

6. Schematic and Gerber

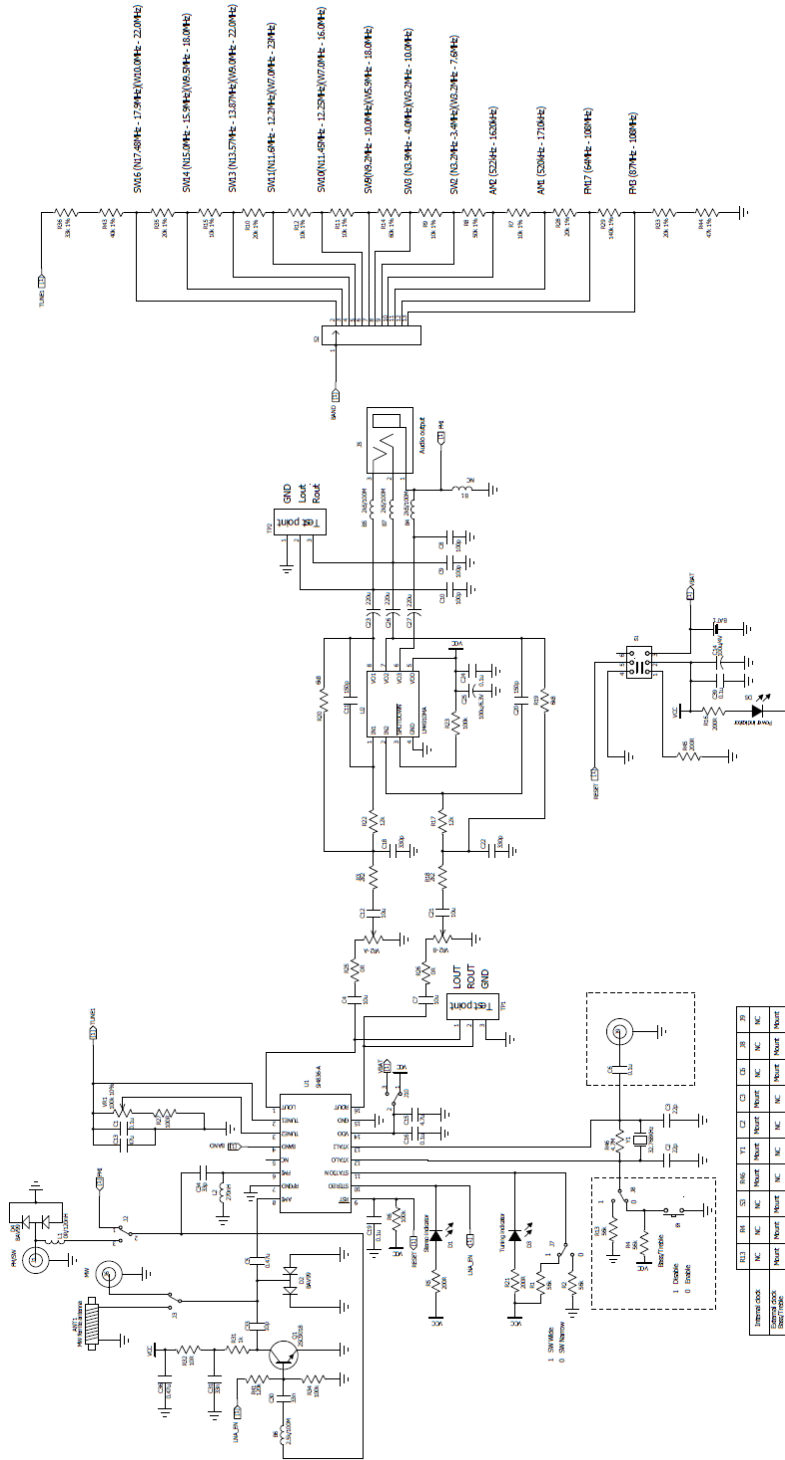

Figure 3. Si4836-DEMO Board Rev 1.1 Schematic

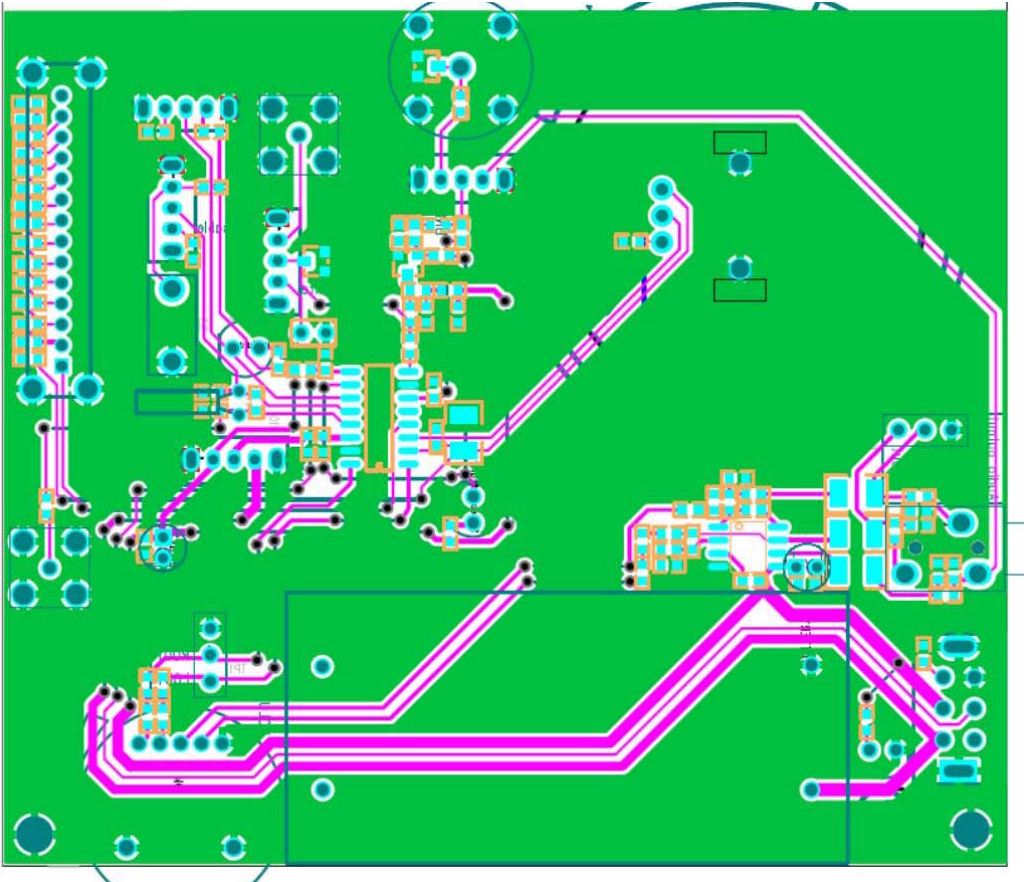

Figure 4. Si4836-DEMO Board Gerber Rev 1.1



Smart.
Connected.
Energy-Friendly



Products
www.silabs.com/products



Quality
www.silabs.com/quality



Support and Community
community.silabs.com

Disclaimer

Silicon Laboratories intends to provide customers with the latest, accurate, and in-depth documentation of all peripherals and modules available for system and software implementers using or intending to use the Silicon Laboratories products. Characterization data, available modules and peripherals, memory sizes and memory addresses refer to each specific device, and "Typical" parameters provided can and do vary in different applications. Application examples described herein are for illustrative purposes only. Silicon Laboratories reserves the right to make changes without further notice and limitation to product information, specifications, and descriptions herein, and does not give warranties as to the accuracy or completeness of the included information. Silicon Laboratories shall have no liability for the consequences of use of the information supplied herein. This document does not imply or express copyright licenses granted hereunder to design or fabricate any integrated circuits. The products must not be used within any Life Support System without the specific written consent of Silicon Laboratories. A "Life Support System" is any product or system intended to support or sustain life and/or health, which, if it fails, can be reasonably expected to result in significant personal injury or death. Silicon Laboratories products are generally not intended for military applications. Silicon Laboratories products shall under no circumstances be used in weapons of mass destruction including (but not limited to) nuclear, biological or chemical weapons, or missiles capable of delivering such weapons.

Trademark Information

Silicon Laboratories Inc., Silicon Laboratories, Silicon Labs, SiLabs and the Silicon Labs logo, CMEMS®, EFM, EFM32, EFR, Energy Micro, Energy Micro logo and combinations thereof, "the world's most energy friendly microcontrollers", Ember®, EZLink®, EZMac®, EZRadio®, EZRadioPRO®, DSPLL®, ISOmodem®, Precision32®, ProSLIC®, SiPHY®, USBXpress® and others are trademarks or registered trademarks of Silicon Laboratories Inc. ARM, CORTEX, Cortex-M3 and THUMB are trademarks or registered trademarks of ARM Holdings. Keil is a registered trademark of ARM Limited. All other products or brand names mentioned herein are trademarks of their respective holders.



Silicon Laboratories Inc.
400 West Cesar Chavez
Austin, TX 78701
USA

<http://www.silabs.com>