

SHP Series: Heavy Duty Modular Power Supplies

The SolaHD SHP Series high power, intelligent modular power supplies, range from 1500 through 4920 watts and were designed for optimum flexibility. The modular design makes these units easy to customize for unusual voltage and power combinations, and the intelligent modules allow the use of I²C or CANBUS/RS485 communication to monitor and control many attributes of the power supply.

All units have power factor corrected inputs, an end mounted fan for cooling and a variety of built-in signals and controls. High reliability and a flexible design make these power supplies an excellent choice for process control and semiconductor fabrication applications.





Applications

- Process Controls
- Semi-Conductor Fabrication
- Automated Service Equipment

Features

- Available in intelligent and non-intelligent models
- Single, dual and triple output modules configurable in combinations up to 24 different outputs
- Single phase and three phase inputs
- I²C control in intelligent modules
- End mounted intelligent fan (speed control/fault status)
- Voltage adjustment on all outputs (manual or I²C)
- CANBUS and RS-485 optional interface
- Overload protection on all outputs
- Power factor correction (.99 typ.)
- Configurable output UP/DOWN sequencing
- Modular Construction
- Configurable input and output OK signals and indicators
- Programmable voltage, current limit, inhibit/enable through I²C
- Three year limited warranty

Certifications and Compliances

-  UL Recognized Component, ITE, E137632
- UL 60950-1/CSA C22.2 No. 60950-1, 2nd Edition
-  - Low Voltage Directive
- IEC/EN 60950-1, 2nd Edition
- RoHS Compliant

Related Products

- Surge Protective Devices
- SCD DC to DC Converters
- Active Tracking® Filters

Standard Offering Selection Table

Catalog Number	Output Voltage	Output Current	Watts
SH30-4LS-0Z	12 V	125 A	1500
SH30-4NS-0Z	15 V	100 A	1500
SH30-4QS-0Z	24 V	62 A	1500
SH30-4RS-0Z	28 V	53 A	1500
SH30-4WS-0Z	48 V	31 A	1500
SH45-4QS-3QS-4Z	24 V	92 A	2000

Accessories Table

Catalog Number	Description
73-769-001	USB to I ² C adapter
70-841-004	Mating Connector Kit for Control & Signals (J1 Connector)
70-841-023	Mating Connector Kit for I ² C Interface (J2 Connector)

Specifications

Description	SH30	SH45	S3H3	S3H5
Input				
Input voltage range	90–264 Vac; 120–300 Vdc; Single phase		170–264 Vac; Three phase	
Frequency	47–63 Hz			
Inrush current	40 A peak maximum (soft start)			
Efficiency	Up to 85% at full load			
Power factor	0.99 typical			
Turn–on time	AC on 1.5 s typical, inhibit/enable 150 ms typical, configurable through I ² C; 50 ms internal turn-on delay (dual output only)			
Hold–up time	10 ms minimum			
AC OK	>5 ms early warning before outputs lose regulation, full cycle ride through at 50 Hz, configurable through I ² C			
Output				
Output voltage range	±10% minimum for all outputs, user-adjustable pot, full adjustment range using I ² C			
Factory set point accuracy	0.01			
I ² C output program accuracy	±5%			
Margining	±4–6% nominal analog (single output module only)			
Line/load regulation	0.4% or 20 mV maximum (1% maximum for 1500 W module)			
Ripple	RMS: 0.1% or 10 mV maximum; Pk-Pk: 1.0% or 50 mV maximum; bandwidth limited to 20 MHz			
Dynamic response	<2% or 100 mv with 25% load step			
Recovery time	Within 1% in <300 μs			
Overcurrent protection	Single output module and main output of the dual output module 105–120% of rated output current. Aux output of dual output module 105–140% of rated output current. Special programmable OCP delay on 1500 W module from 100 ms to 25.5 s with shutdown features. Configurable through I ² C with load calibration required (except for 1500 W module).			
Short–circuit protection	Protected for continuous short-circuit; recovery is automatic upon removal of short. Shutdown mode available on the 1500 W module.			
Overvoltage protection	Single output module: 2–5.5 V, 122–134%; 6–60 V, 110–120%; Dual output module: 2–6 V, 122–134%; 8–28 V, 110–120% Triple output module: No overvoltage protection provided; Configurable through I ² C			
Thermal protection	All outputs are disabled when the internal temperature exceeds the safe operating range; configurable through I ² C			
Remote sense	Up to 0.5 V drop (not available on triple output module)			
Single wire parallel	Current share to within 2% of total rated current			
DC OK	±5% of nominal; configurable through I ² C			
Minimum load	Not required			
Housekeeping bias voltage	5 V dc @ 1.0 A maximum present whenever ac input is applied			
Module inhibit	Configured and controlled through I ² C			
Output/output isolation	>1 MΩ, 500 V			
Global inhibit/enable	TTL, Logic “1” and Logic “0”; configurable through I ² C			
Environmental				
Operating temperature	–40°C to +70°C ambient; derate each output 2.5% per degree from 50°C to 70°C			
Storage temperature	–40°C to +85°C			
Humidity	10% to 95% RH, non-condensing			
Vibration	IEC68-2-6 to the levels of IEC721-3-2			
MTBF demonstrated	>550,000 hr. @ full load, 220 V ac, 25°C ambient			
Safety				
Electromagnetic susceptibility	EN61000-4-2, EN61000-4-4, EN61000-4-5 Level 3			
EMI filter	CISPR 22/EN55022 Level B when installed in a properly grounded and shielded metal enclosure			
Radiated EMI	CISPR 22/EN55022 Level B when installed in a properly grounded and shielded metal enclosure			
General				
Case dimensions H x W x D – in (mm)	5 x 5 x 11 (127.0 x 127.0 x 279.4)	5 x 8 x 11 (127.0 x 203.2 x 279.4)	5 x 5 x 11 (127.0 x 127.0 x 279.4)	5 x 8 x 11 (127.0 x 203.2 x 279.4)
Case weight – lbs (kg)	6.2 (2.81)	9.0 (4.08)	6.2 (2.81)	9.0 (4.08)
Slots available per case	9	14	9	14
Limited warranty	3 years			

Output Module Specification Overview

Intelligent Module Code	1	2	3	4	5		6
Module Type	Single	Single	Single	Single	Dual		Triple
Max output power ¹	210 W	360 W	750 W	1500 W	144 W		36 W
Max output current ²	35 A	60 A	150 A	140 A	10 A		2 A
Output voltages available	2-60 V	2-60 V	2-60 V	6-60 V	8-15, 24-28; 8-15, 8-15; 8-15, 2-6; 2-6, 2-6; 24-28, 24-28; 24-28, 2-6		8-15, 8-15, 2-6; 8-15, 8-15; 8-15, 8-15, 18-28; 8-15, 18-28, 2-6
Standard voltage increments	25	25	25	18	16		18
Remote sense	Yes	Yes	Yes	Yes	Yes	Yes	No
Remote margin	Yes	Yes	Yes	Yes	No	No	No
V-Program – I ² C control	Yes	Yes	Yes	Yes	Yes	Yes	No
Active current share	Yes	Yes	Yes	Yes	Yes	No	No
Module inhibit – I ² C control	Yes	Yes	Yes	Yes	Yes	Yes	Yes
Module inhibit – Analog	Yes	Yes	Yes	Yes	No	No	No
Overvoltage/Overcurrent protection	Yes	Yes	Yes	Yes	Yes	Yes	Yes
Minimum load required	No	No	No	No	No	No	No
Slots occupied in any SHP case	1	2	3	4	1		1
Weight – lbs (kg)	0.6 (0.27)	1.0 (0.45)	1.6 (0.73)	2.0 (0.91)	0.6 (0.27)		0.5 (0.23)

Non-Intelligent Module Code	1	2	3	-	5		6
Module Type	Single	Single	Single	-	Dual		Triple
Max output power	210 W	360 W	600 W	-	144 W		36 W
Max output current	35 A	60 A	120 A	-	10 A		2 A
Output voltages available	2-60 V	2-60 V	2-60 V	-	2-28 V		2-28 V
Standard voltage increments	25	25	25	-	19		18
Remote sense	Yes	Yes	Yes	-	Yes	Yes	No
Remote margin/V-Program	Yes	Yes	Yes	-	No	No	No
Module inhibit – isolated	Yes	Yes	Yes	-	-	-	-
Single wire active current share	Yes	Yes	Yes	-	Yes	No	-
Overvoltage/Overcurrent protection	Yes	Yes	Yes	-	Yes	Yes	Overcurrent
Minimum load required	No	No	No	-	Yes (10% of load)	No	No
Slots occupied in any SHP case	1	2	3	-	1		1
Weight ³ – lbs (kg)	0.6 (0.27)	1.0 (0.45)	2.0 (0.91)	-	0.6 (0.27)		0.5 (0.23)

Notes:

- 1) For dual & triple output modules: the max output power is the total amount of power for the module.
- 2) For dual & triple output modules: the max output current is the total max current for each output.
- 3) To calculate the total weight of the power supply: sum up the weight for each module and add it to the weight of the case given under the Specifications Table.

Catalog Numbering Selection

Intelligent Model







Example: 4500 W case with: a 1500 W module set at 24 V @ 62.5 A and a 750 W module set at 24 V @ 30 A connected in parallel for a total of 24 V @ 92.5 A single output.

SH45-4QS-3QS-4Z

Case Size	Module Codes	Case Options
<p>Single Phase Input SH30 = 1500 W - 3210 W, 9 Slots SH45 = 1800 W - 4500 W, 14 Slots</p> <p>Three Phase Input S3H3 = 3120 W, 9 Slots S3H5 = 4920 W, 14 Slots</p>	<p>1 = 210 W single O/P (1 slot) 2 = 360 W single O/P (2 slot) 3 = 750 W single O/P (3 slot) 4 = 1500 W single O/P (4 Slot) 5 = 144 W dual O/P (1 slot) 6 = 36 W triple O/P (1 slot) X = Extra 30mS hold-up (1 slot) ¹</p> <p>Output Voltage Codes See Output Module Voltage/Current Table for Intelligent Modules</p> <p>Module Option Codes S = Standard T = Module enable U = Constant current V = T & U combined W = Shutdown mode for 1500 W Y = T & W combined</p>	<p>Paralleling Options 0 = No Parallel Option 1-19 = See Parallel Code Table</p> <p>Special Options Z = No Options R = Reverse air N = Not used G = Global enable F = Fan Idle w/inhibit H = Opt R + Opt G I = Opt R + Opt F J = Opt G + Opt F K = Opt R + G + F C = CANBUS/RS485 (73-544-001) B = USB (73-546-001)</p>

Output Voltage/Current Table for Intelligent Modules ²

Voltage	Voltage Code	Single Output			Dual Output ³		Triple Output			I ² C Adjustment Ranges ⁴	
		1	2	3	4	5	6	6	6		
Module Code											
2 V	A	35 A	60 A	150 A	-	10 A	10 A	-	-	2 A	1.8 - 2.2 V
2.2 V	B	35 A	60 A	150 A	-	10 A	10 A	-	-	2 A	2.0 - 2.4 V
3 V	C	35 A	60 A	150 A	-	10 A	10 A	-	-	2 A	2.7 - 3.3 V
3.3 V	D	35 A	60 A	150 A	-	10 A	10 A	-	-	2 A	3.0 - 3.6 V
5 V	E	35 A	60 A	150 A	-	10 A	10 A	-	-	2 A	4.5 - 5.5 V
5.2 V	F	35 A	60 A	144 A	-	10 A	10 A	-	-	2 A	4.7 - 5.7 V
5.5 V	G	34 A	58 A	136 A	-	10 A	10 A	-	-	2 A	5.0 - 6.1 V
6.0 V	H	23 A	42 A	97.5 A	140 A	10 A	10 A	-	-	2 A	5.4 - 6.6 V
8.0 V	I	20 A	36 A	84.4 A	140 A	10 A	4 A	1 A	1 A	1 A	7.2 - 8.8 V
10 V	J	18 A	32 A	75 A	140 A	10 A	4 A	1 A	1 A	1 A	9.0 - 11.0 V
11 V	K	17 A	31 A	68 A	136.3 A	10 A	4 A	1 A	1 A	1 A	9.9 - 12.1 V
12 V	L	17 A	30 A	62.5 A	125 A	10 A	4 A	1 A	1 A	1 A	10.8 - 13.2 V
14 V	M	14 A	21 A	53.5 A	107 A	9 A	4 A	1 A	1 A	1 A	12.6 - 15.4 V
15 V	N	14 A	20 A	50 A	100 A	8 A	4 A	1 A	1 A	1 A	13.5 - 16.5 V
18 V	O	11 A	19 A	41.6 A	83.3 A	-	-	-	0.5 A	0.5 A	16.2 - 19.8 V
20 V	P	10.5 A	18 A	37.5 A	75 A	-	-	-	0.5 A	0.5 A	18.0 - 22.0 V
24 V	Q	8.5 A	15 A	30 A	62.5 A	4 A	2 A	-	0.5 A	0.5 A	21.6 - 26.4 V
28 V	R	6.7 A	11 A	26.8 A	53.5 A	3 A	2 A	-	0.5 A	0.5 A	25.2 - 30.8 V
30 V	S	6.5 A	11 A	25 A	50 A	-	-	-	-	-	27.0 - 33.0 V
33 V	T	6.2 A	10.9 A	22.7 A	35.8 A	-	-	-	-	-	29.7 - 36.3 V
36 V	U	5.8 A	10 A	20.8 A	35.8 A	-	-	-	-	-	32.4 - 39.6 V
42 V	V	4.2 A	7.5 A	16 A	35.7 A	-	-	-	-	-	37.8 - 46.2 V
48 V	W	4.0 A	7.5 A	15.6 A	31.2 A	-	-	-	-	-	43.2 - 52.8 V
54 V	X	3.7 A	6.0 A	13.9 A	27.7 A	-	-	-	-	-	48.6 - 59.4 V
60 V	Y	3.5 A	6.0 A	12.5 A	25 A	-	-	-	-	-	54.0 - 66.0 V

SHP Series: Intelligent Modules	
Single	
 210 W	 750 W
 360 W	 1500 W
Dual	
 144 W	 36 W

- Notes:
- 1) Certifications pending.
 - 2) Increments of current not shown can be achieved by paralleling modules. See Parallel Code Table.
 - 3) Total output power on dual and triple modules must not exceed the max output power rating for the module.
 - 4) I²C Adjustment Ranges apply to single output modules only.

Catalog Numbering Selection





Non-Intelligent Model

Example: 3210 W case with: a 36 W triple output module set at 11 V @ 1A, 24 V @ 0.5 A, 5 V @ 2 A and a 600 W module set at 24 V @ 23.5 A.

SH30-6KQE-3Q-0Z

Case Size	Module Codes	Case Options
<p>Single Phase Input SH30 = 1500 W - 3210 W, 9 Slots SH45 = 1800 W - 4500 W, 14 Slots</p> <p>Three Phase Input S3H3 = 3120 W, 9 Slots S3H5 = 4920 W, 14 Slots</p>	<p>1 = 210 W single O/P (1 slot) 2 = 360 W single O/P (2 slot) 3 = 600 W single O/P (3 slot) 5 = 144 W dual O/P (1 slot) 6 = 36 W triple O/P (1 slot) X = Extra 30mS hold-up (1 slot) ¹</p> <p>Output Voltage Codes See Output Module Voltage/Current Tables for Standard Modules</p>	<p>Paralleling Options 0 = No Parallel Option 1-19 = See Parallel Code Table</p> <p>Special Options Z = No Options R = Reverse air N = Not used G = Global enable F = Fan Idle w/inhibit H = Opt R + Opt G I = Opt R + Opt F J = Opt G + Opt F K = Opt R + G + F C = CANBUS/RS485 (73-544-001) ² B = USB (73-546-001) ²</p>

SHP Series: Non-Intelligent Modules

Single	
 210 W	 360 W
 600 W	
Dual	Triple
 144 W	 36 W

Output Voltage/Current Table for Non-Intelligent Modules ³

Voltage	Voltage Code	Single Output			Dual Output ⁴		Triple Output		
Module Code									
Module Code		1	2	3	5	5	6	6	6
2 V	A	35 A	60 A	120 A	-	10 A	-	-	2 A
2.2 V	B	35 A	60 A	120 A	-	10 A	-	-	2 A
3 V	C	35 A	60 A	120 A	-	10 A	-	-	2 A
3.3 V	D	35 A	60 A	120 A	-	10 A	-	-	2 A
5 V	E	35 A	60 A	120 A	10 A	10 A	-	-	2 A
5.2 V	F	35 A	60 A	115 A	-	10 A	-	-	2 A
5.5 V	G	34 A	58 A	109 A	-	10 A	-	-	2 A
6.0 V	H	23 A	42 A	78 A	-	10 A	-	-	2 A
8.0 V	I	20 A	36 A	68 A	-	-	1 A	1 A	1 A
10 V	J	18 A	32 A	60 A	-	-	1 A	1 A	1 A
11 V	K	17 A	31 A	54.5 A	-	-	1 A	1 A	1 A
12 V	L	17 A	30 A	50 A	10 A	4 A	1 A	1 A	1 A
14 V	M	14 A	21 A	40.5 A	9 A	4 A	1 A	1 A	1 A
15 V	N	14 A	20 A	39 A	8 A	4 A	1 A	1 A	1 A
18 V	O	11 A	19 A	33.3 A	-	-	-	0.5 A	0.5 A
20 V	P	10.5 A	18 A	30 A	-	-	-	0.5 A	0.5 A
24 V	Q	8.5 A	15 A	23.5 A	4 A	2 A	-	0.5 A	0.5 A
28 V	R	6.7 A	12.8 A	21.4 A	3 A	2 A	-	0.5 A	0.5 A
30 V	S	6.5 A	12 A	20 A	-	-	-	-	-
33 V	T	6.2 A	10.9 A	18.2 A	-	-	-	-	-
36 V	U	5.8 A	10 A	16.6 A	-	-	-	-	-
42 V	V	4.2 A	7.5 A	12.5 A	-	-	-	-	-
48 V	W	4.0 A	7.5 A	12.5 A	-	-	-	-	-
54 V	X	3.7 A	6.0 A	11 A	-	-	-	-	-
60 V	Y	3.5 A	6.0 A	10 A	-	-	-	-	-

Notes:

- 1) Certifications pending.
- 2) Only the input parameters will have communications capabilities with these options. Non-intelligent modules do not provide communication capabilities on the output side.
- 3) Increments of current not shown can be achieved by paralleling modules. See Parallel Code Table.
- 4) Total output power on dual and triple modules must not exceed the max output power rating for the module.

Parallel Code Table

Parallel Code		SH30 & S3H3		SH45 & S3H5																											
	Slot No.	Possible Configurations (Modules in Watts)		Slot No.	Possible Configurations (Modules in Watts)																										
1	1 & 2	<table border="1"><tr><td>AC</td><td>9</td><td>8</td><td>7</td><td>6</td></tr><tr><td>5</td><td>4</td><td>3</td><td>2</td><td>1</td></tr></table>	AC	9	8	7	6	5	4	3	2	1	210-210; 210-144; 144-144	1 & 2	<table border="1"><tr><td>AC</td><td>14</td><td>13</td><td>12</td><td>11</td><td>10</td><td>9</td></tr><tr><td>8</td><td>7</td><td>6</td><td>5</td><td>4</td><td>3</td><td>2</td><td>1</td></tr></table>	AC	14	13	12	11	10	9	8	7	6	5	4	3	2	1	210-210; 210-144; 144-144
AC	9	8	7	6																											
5	4	3	2	1																											
AC	14	13	12	11	10	9																									
8	7	6	5	4	3	2	1																								
2	2 & 3	<table border="1"><tr><td>AC</td><td>9</td><td>8</td><td>7</td><td>6</td></tr><tr><td>5</td><td>4</td><td>3</td><td>2</td><td>1</td></tr></table>	AC	9	8	7	6	5	4	3	2	1	360-360; 360-210; 360-144; + above	2 & 3	<table border="1"><tr><td>AC</td><td>14</td><td>13</td><td>12</td><td>11</td><td>10</td><td>9</td></tr><tr><td>8</td><td>7</td><td>6</td><td>5</td><td>4</td><td>3</td><td>2</td><td>1</td></tr></table>	AC	14	13	12	11	10	9	8	7	6	5	4	3	2	1	360-360; 360-210; 360-144; + above
AC	9	8	7	6																											
5	4	3	2	1																											
AC	14	13	12	11	10	9																									
8	7	6	5	4	3	2	1																								
3	3 & 4	<table border="1"><tr><td>AC</td><td>9</td><td>8</td><td>7</td><td>6</td></tr><tr><td>5</td><td>4</td><td>3</td><td>2</td><td>1</td></tr></table>	AC	9	8	7	6	5	4	3	2	1	750-360; 750-210; 750-144; 210-210; 210-144; 144-144	3 & 4	<table border="1"><tr><td>AC</td><td>14</td><td>13</td><td>12</td><td>11</td><td>10</td><td>9</td></tr><tr><td>8</td><td>7</td><td>6</td><td>5</td><td>4</td><td>3</td><td>2</td><td>1</td></tr></table>	AC	14	13	12	11	10	9	8	7	6	5	4	3	2	1	750-750; 750-360; 750-210; 750-144; 210-210; 210-144; 144-144
AC	9	8	7	6																											
5	4	3	2	1																											
AC	14	13	12	11	10	9																									
8	7	6	5	4	3	2	1																								
4	4 & 5	<table border="1"><tr><td>AC</td><td>9</td><td>8</td><td>7</td><td>6</td></tr><tr><td>5</td><td>4</td><td>3</td><td>2</td><td>1</td></tr></table>	AC	9	8	7	6	5	4	3	2	1	1500-210; 1500-144; 210-210; 210-144; 144-144; 360-210; 360-144	4 & 5	<table border="1"><tr><td>AC</td><td>14</td><td>13</td><td>12</td><td>11</td><td>10</td><td>9</td></tr><tr><td>8</td><td>7</td><td>6</td><td>5</td><td>4</td><td>3</td><td>2</td><td>1</td></tr></table>	AC	14	13	12	11	10	9	8	7	6	5	4	3	2	1	1500-1500; 1500-750; 1500-360; 1500-210; 1500-144; 210-210; 210-144; 144-144; 360-360; 360-210; 360-144
AC	9	8	7	6																											
5	4	3	2	1																											
AC	14	13	12	11	10	9																									
8	7	6	5	4	3	2	1																								
5	3, 4, & 5	<table border="1"><tr><td>AC</td><td>9</td><td>8</td><td>7</td><td>6</td></tr><tr><td>5</td><td>4</td><td>3</td><td>2</td><td>1</td></tr></table>	AC	9	8	7	6	5	4	3	2	1	750-210-210; 750-210-144; 750-144-144	3, 4, & 5	<table border="1"><tr><td>AC</td><td>14</td><td>13</td><td>12</td><td>11</td><td>10</td><td>9</td></tr><tr><td>8</td><td>7</td><td>6</td><td>5</td><td>4</td><td>3</td><td>2</td><td>1</td></tr></table>	AC	14	13	12	11	10	9	8	7	6	5	4	3	2	1	750-210-210; 750-210-144; 750-144-144
AC	9	8	7	6																											
5	4	3	2	1																											
AC	14	13	12	11	10	9																									
8	7	6	5	4	3	2	1																								
6	4 & 6	<table border="1"><tr><td>AC</td><td>9</td><td>8</td><td>7</td><td>6</td></tr><tr><td>5</td><td>4</td><td>3</td><td>2</td><td>1</td></tr></table>	AC	9	8	7	6	5	4	3	2	1	1500-1500; 1500-750	—	—	—															
AC	9	8	7	6																											
5	4	3	2	1																											
7	4, 5, & 6	<table border="1"><tr><td>AC</td><td>9</td><td>8</td><td>7</td><td>6</td></tr><tr><td>5</td><td>4</td><td>3</td><td>2</td><td>1</td></tr></table>	AC	9	8	7	6	5	4	3	2	1	1500-210-210; 1500-210-144; 1500-144-144	4, 5, & 6	<table border="1"><tr><td>AC</td><td>14</td><td>13</td><td>12</td><td>11</td><td>10</td><td>9</td></tr><tr><td>8</td><td>7</td><td>6</td><td>5</td><td>4</td><td>3</td><td>2</td><td>1</td></tr></table>	AC	14	13	12	11	10	9	8	7	6	5	4	3	2	1	1500-210-210; 1500-210-144; 1500-144-144
AC	9	8	7	6																											
5	4	3	2	1																											
AC	14	13	12	11	10	9																									
8	7	6	5	4	3	2	1																								
8	3 & 6	<table border="1"><tr><td>AC</td><td>9</td><td>8</td><td>7</td><td>6</td></tr><tr><td>5</td><td>4</td><td>3</td><td>2</td><td>1</td></tr></table>	AC	9	8	7	6	5	4	3	2	1	750-750	4, 5, & 9	<table border="1"><tr><td>AC</td><td>14</td><td>13</td><td>12</td><td>11</td><td>10</td><td>9</td></tr><tr><td>8</td><td>7</td><td>6</td><td>5</td><td>4</td><td>3</td><td>2</td><td>1</td></tr></table>	AC	14	13	12	11	10	9	8	7	6	5	4	3	2	1	1500-1500-1500; 1500-1500-750; 1500-1500-360; 1500-1500-210; 1500-1500-144
AC	9	8	7	6																											
5	4	3	2	1																											
AC	14	13	12	11	10	9																									
8	7	6	5	4	3	2	1																								
9	1 & 6	<table border="1"><tr><td>AC</td><td>9</td><td>8</td><td>7</td><td>6</td></tr><tr><td>5</td><td>4</td><td>3</td><td>2</td><td>1</td></tr></table>	AC	9	8	7	6	5	4	3	2	1	1500-1500; 1500-360; 1500-144	4, 5 & 9; 12 & 13	<table border="1"><tr><td>AC</td><td>14</td><td>13</td><td>12</td><td>11</td><td>10</td><td>9</td></tr><tr><td>8</td><td>7</td><td>6</td><td>5</td><td>4</td><td>3</td><td>2</td><td>1</td></tr></table>	AC	14	13	12	11	10	9	8	7	6	5	4	3	2	1	1500-1500-1500-360; 1500-1500-1500-210; 1500-1500-1500-144
AC	9	8	7	6																											
5	4	3	2	1																											
AC	14	13	12	11	10	9																									
8	7	6	5	4	3	2	1																								
10	3 & 4; 8 & 9	<table border="1"><tr><td>AC</td><td>9</td><td>8</td><td>7</td><td>6</td></tr><tr><td>5</td><td>4</td><td>3</td><td>2</td><td>1</td></tr></table>	AC	9	8	7	6	5	4	3	2	1	750-210 & 750-210	4 & 5; 11 & 12	<table border="1"><tr><td>AC</td><td>14</td><td>13</td><td>12</td><td>11</td><td>10</td><td>9</td></tr><tr><td>8</td><td>7</td><td>6</td><td>5</td><td>4</td><td>3</td><td>2</td><td>1</td></tr></table>	AC	14	13	12	11	10	9	8	7	6	5	4	3	2	1	1500-1500 & 750-750
AC	9	8	7	6																											
5	4	3	2	1																											
AC	14	13	12	11	10	9																									
8	7	6	5	4	3	2	1																								
11	3, 4 & 6	<table border="1"><tr><td>AC</td><td>9</td><td>8</td><td>7</td><td>6</td></tr><tr><td>5</td><td>4</td><td>3</td><td>2</td><td>1</td></tr></table>	AC	9	8	7	6	5	4	3	2	1	750-360-750	6 & 7; 3, 4, 11 & 12	<table border="1"><tr><td>AC</td><td>14</td><td>13</td><td>12</td><td>11</td><td>10</td><td>9</td></tr><tr><td>8</td><td>7</td><td>6</td><td>5</td><td>4</td><td>3</td><td>2</td><td>1</td></tr></table>	AC	14	13	12	11	10	9	8	7	6	5	4	3	2	1	750, 750, 360, 750, 750
AC	9	8	7	6																											
5	4	3	2	1																											
AC	14	13	12	11	10	9																									
8	7	6	5	4	3	2	1																								
12	3, 4, 6; 8 & 9	<table border="1"><tr><td>AC</td><td>9</td><td>8</td><td>7</td><td>6</td></tr><tr><td>5</td><td>4</td><td>3</td><td>2</td><td>1</td></tr></table>	AC	9	8	7	6	5	4	3	2	1	750, 360, 750, 210	3, 4, 11, & 12	<table border="1"><tr><td>AC</td><td>14</td><td>13</td><td>12</td><td>11</td><td>10</td><td>9</td></tr><tr><td>8</td><td>7</td><td>6</td><td>5</td><td>4</td><td>3</td><td>2</td><td>1</td></tr></table>	AC	14	13	12	11	10	9	8	7	6	5	4	3	2	1	750, 750, 750, 750
AC	9	8	7	6																											
5	4	3	2	1																											
AC	14	13	12	11	10	9																									
8	7	6	5	4	3	2	1																								
13	7 & 8	<table border="1"><tr><td>AC</td><td>9</td><td>8</td><td>7</td><td>6</td></tr><tr><td>5</td><td>4</td><td>3</td><td>2</td><td>1</td></tr></table>	AC	9	8	7	6	5	4	3	2	1	360-360	3 & 4; 11 & 12	<table border="1"><tr><td>AC</td><td>14</td><td>13</td><td>12</td><td>11</td><td>10</td><td>9</td></tr><tr><td>8</td><td>7</td><td>6</td><td>5</td><td>4</td><td>3</td><td>2</td><td>1</td></tr></table>	AC	14	13	12	11	10	9	8	7	6	5	4	3	2	1	750-360 & 750-210; 750-750 & 750-750
AC	9	8	7	6																											
5	4	3	2	1																											
AC	14	13	12	11	10	9																									
8	7	6	5	4	3	2	1																								
14	—	—	—	3, 4 & 9	<table border="1"><tr><td>AC</td><td>14</td><td>13</td><td>12</td><td>11</td><td>10</td><td>9</td></tr><tr><td>8</td><td>7</td><td>6</td><td>5</td><td>4</td><td>3</td><td>2</td><td>1</td></tr></table>	AC	14	13	12	11	10	9	8	7	6	5	4	3	2	1	750-750-750										
AC	14	13	12	11	10	9																									
8	7	6	5	4	3	2	1																								
15	—	—	—	11 & 12	<table border="1"><tr><td>AC</td><td>14</td><td>13</td><td>12</td><td>11</td><td>10</td><td>9</td></tr><tr><td>8</td><td>7</td><td>6</td><td>5</td><td>4</td><td>3</td><td>2</td><td>1</td></tr></table>	AC	14	13	12	11	10	9	8	7	6	5	4	3	2	1	750-750										
AC	14	13	12	11	10	9																									
8	7	6	5	4	3	2	1																								
16	—	—	—	4 & 5; 9 & 10	<table border="1"><tr><td>AC</td><td>14</td><td>13</td><td>12</td><td>11</td><td>10</td><td>9</td></tr><tr><td>8</td><td>7</td><td>6</td><td>5</td><td>4</td><td>3</td><td>2</td><td>1</td></tr></table>	AC	14	13	12	11	10	9	8	7	6	5	4	3	2	1	1500-210 & 210-1500										
AC	14	13	12	11	10	9																									
8	7	6	5	4	3	2	1																								
17	—	—	—	1 & 9; 5 & 12	<table border="1"><tr><td>AC</td><td>14</td><td>13</td><td>12</td><td>11</td><td>10</td><td>9</td></tr><tr><td>8</td><td>7</td><td>6</td><td>5</td><td>4</td><td>3</td><td>2</td><td>1</td></tr></table>	AC	14	13	12	11	10	9	8	7	6	5	4	3	2	1	1500-750 & 1500-750										
AC	14	13	12	11	10	9																									
8	7	6	5	4	3	2	1																								
18	—	—	—	3 & 4; 7 & 8; 9 & 10	<table border="1"><tr><td>AC</td><td>14</td><td>13</td><td>12</td><td>11</td><td>10</td><td>9</td></tr><tr><td>8</td><td>7</td><td>6</td><td>5</td><td>4</td><td>3</td><td>2</td><td>1</td></tr></table>	AC	14	13	12	11	10	9	8	7	6	5	4	3	2	1	750-210 & 750-210 & 210-1500										
AC	14	13	12	11	10	9																									
8	7	6	5	4	3	2	1																								
19	—	—	—	3, 4 & 9; 6 & 7	<table border="1"><tr><td>AC</td><td>14</td><td>13</td><td>12</td><td>11</td><td>10</td><td>9</td></tr><tr><td>8</td><td>7</td><td>6</td><td>5</td><td>4</td><td>3</td><td>2</td><td>1</td></tr></table>	AC	14	13	12	11	10	9	8	7	6	5	4	3	2	1	750, 750, 360, 750										
AC	14	13	12	11	10	9																									
8	7	6	5	4	3	2	1																								

Connector Tables

Table 1: AC Input			
PIN #	FUNCTION		FUNCTION
	SH30 & SH45	S3H3 & S3H5	
1	AC neutral (DC -)	L1	L1
2	AC line (DC +)	L2	L2
3	Chassis (earth) ground	L3	L3
4	—	Chassis (earth) ground	⊕

BARRIER TYPE
 SH30: THREE #6-32 BH SCREWS, 6 in.-lbs. (0.67 N-m) TORQUE
 SH45: THREE M4 SCREWS, 7 in.-lbs. (0.79 N-m) TORQUE
 S3H3: FOUR M3 SCREWS, 6 in.-lbs. (0.67 N-m) TORQUE
 S3H5: THREE M3.5 SCREWS, 6 in.-lbs. (0.67 N-m) TORQUE

Table 2: PFC Input Connector (Control & Signals)		
PIN #	FUNCTION	
	SH30 & SH45	S3H3 & S3H5
1	Input ac OK (emitter)	L1
2	Input ac OK (collector)	L2
3	Global dc OK (emitter)	L3
4	Global dc OK (collector)	L3
5	No connection	
6	Global inhibit/optional enable logic "0"	
7	Global inhibit/optional enable logic "1"	
8	Global inhibit/optional enable return	
9	+5 VSB housekeeping (1A max)	
10	+5 VSB housekeeping return	

MATES WITH:
 MOLEX 90142-0010 HOUSING
 MOLEX 90119-2110 TERMINAL
CONNECTOR KIT P/N 70-841-004

Table 3: I ² C Bus Output Connector		
PIN #	FUNCTION	
	SH30 & SH45	S3H3 & S3H5
1		
2	No connection	
3		
4	Serial clock signal (SCL)	
5	Serial data signal (SDA)	
6	Address bit 0 (A0)	
7	Address bit 1 (A1)	
8	Address bit 2 (A2)	
9	Secondary return (GND)	
10	5 Vcc external bus (1A max)	

MATES WITH:
 JST PHDR-10 VS HOUSING
 JST SPHD-002T-P0.5 TERMINAL (FOR 24-28 AWG WIRE)
 JST SPHD-001T-P0.5 TERMINAL (FOR 24-28 AWG WIRE) OR
 LAND WIN 2050S1000 HOUSING
 LAND WIN 2053T011P TERMINAL
CONNECTOR KIT P/N 70-841-023

Table 4: DC Output Connector (Located on output modules)		
PIN #	FUNCTION	
	SH30 & SH45	S3H3 & S3H5
1	+ Remote sense (single or dual o/p main)	
2	Remote margin/V. program (single o/p)	
3	Margin high (single o/p)	
4	- Remote sense/margin low (single or dual o/p main)	
5	Spare	
6	Module isolated inhibit (single or dual o/p)	
7	Module inhibit return (single or dual o/p)	
8	Current share (SWP) (single or dual o/p main)	
9	+ Remote sense V2 (dual o/p, single is spare)	
10	- Remote sense V2 (dual o/p, single is spare)	

MATES WITH:
 MOLEX 90142-0010 HOUSING
 MOLEX 90119-2110 TERMINAL
CONNECTOR KIT P/N 70-841-004

Notes:

Output Module Connections: M4 x 8 mm screws for all single output modules; maximum torque is 10 in.-lb. (1.13 N-m).

M3 x 8 mm screws for dual output module; maximum torque is 5 in.-lb. (0.57 N-m).

36 W triple output module connector mates with Molex 09-91-0600 housing and Molex 26-60-5060 terminals.

Case Specifications

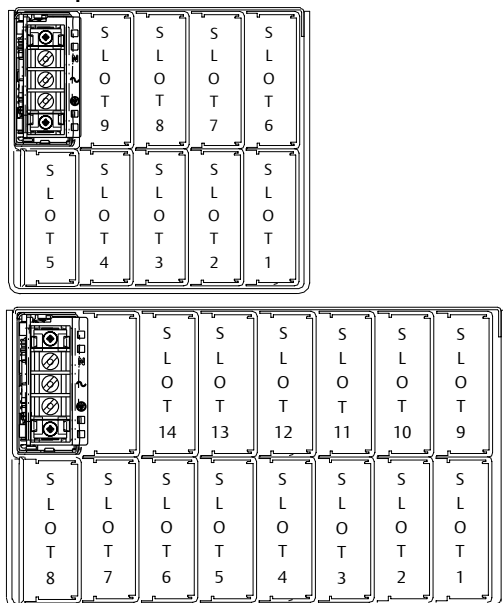

Case Dimensions	Input	
SH30 = 5" x 5" x 11" (127 x 127 x 279.4 mm) 9 available slots, Single phase	90-264 Vac 1500 W max.	170-264 Vac 3210 W max.
S3H3 = 5" x 5" x 11" (127 x 127 x 279.4 mm) 9 available slots, Three phase	N/A	170-264 Vac 3210 W max.
SH45 = 5" x 8" x 11" (127 x 203.2 x 279.4 mm) 14 available slots, Single phase	90-264 Vac 1800 W max.	170-264 Vac 4500 W max.
S3H5 = 5" x 8" x 11" (127 x 203.2 x 279.4 mm) 14 available slots, Three phase	N/A	170-264 Vac 4920 W max.

SH30 and S3H3 Dimensional Drawings – in. (mm)

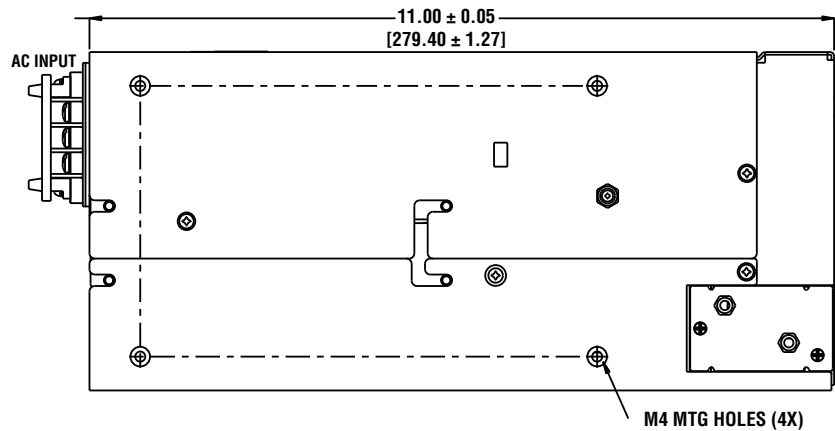
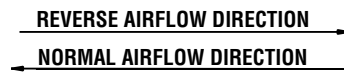
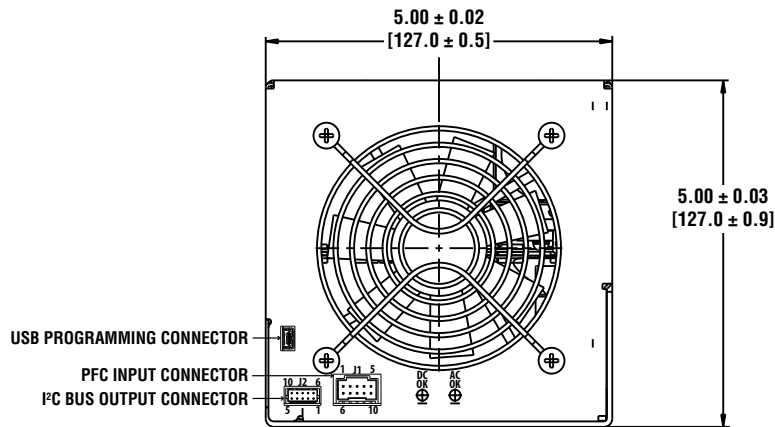

Notes:

1. See Connectors Table 1 for screw types.
2. Chassis material: aluminum with chemical film coating (conductive).
3. All dimensions are in millimeters and inches, and are typical.
4. Customer mounting - 3 sides M4, bottom also includes 8-32 mounting holes. Max. penetration is 0.155" (4.0 mm). Max. torque: 5in-lbs. (0.57 N-m).

SH45 and S3H5 Dimensional Drawings – in. (mm)

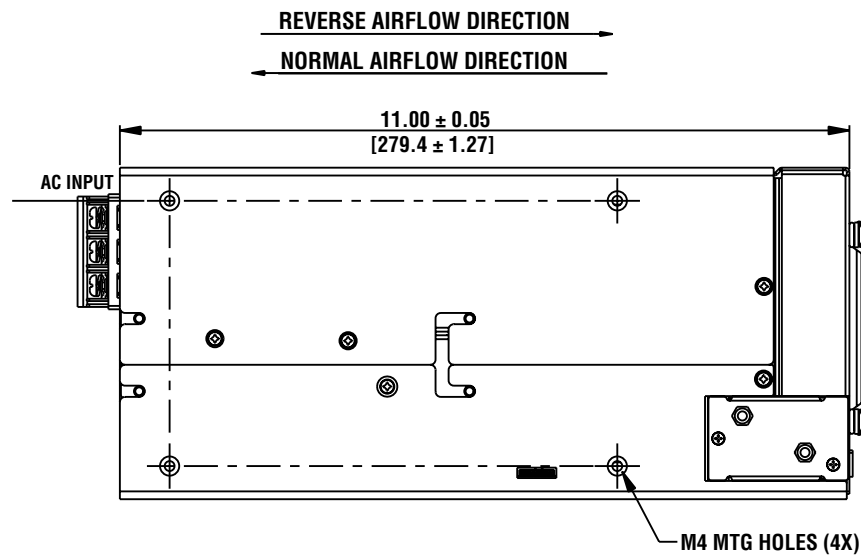
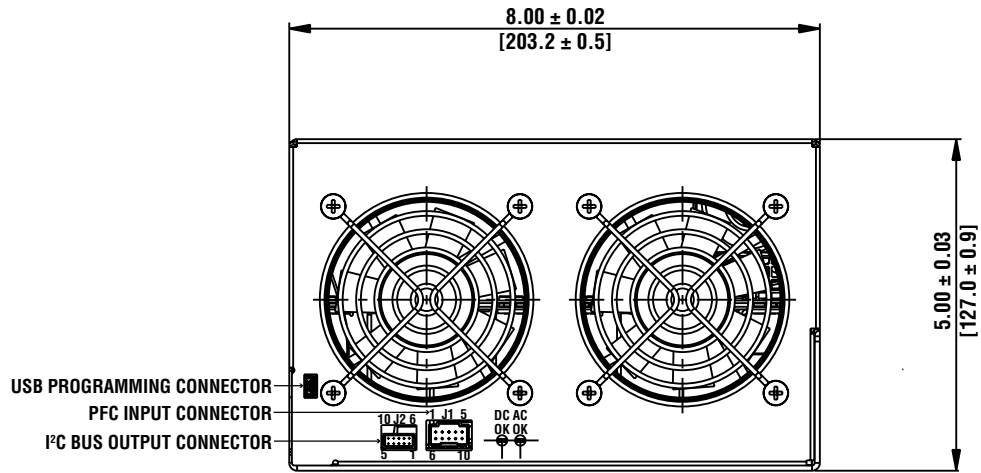

Notes:

1. See Connectors Table 1 for screw types.
2. Chassis material: aluminum with chemical film coating (conductive).
3. All dimensions are in millimeters and inches, and are typical.
4. Customer mounting - 3 sides M4, bottom also includes 8-32 mounting holes. Max. penetration is 0.155" (4.0 mm). Max. torque: 5 in-lbs. (0.57 N-m).

Intelligent Modules Dimensional Drawings – in. (mm)

Single 210 Watt

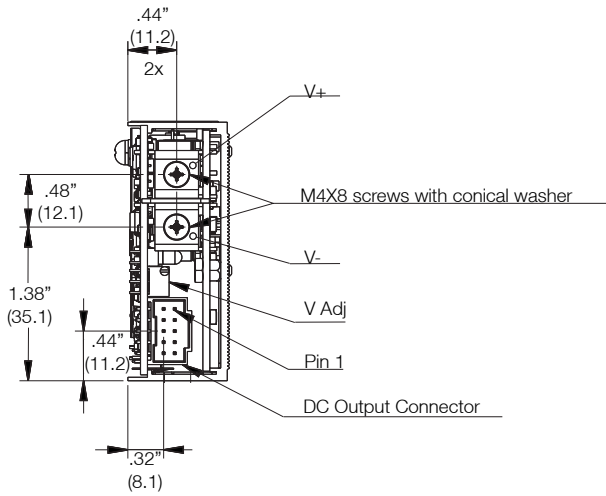

Single 360 Watt

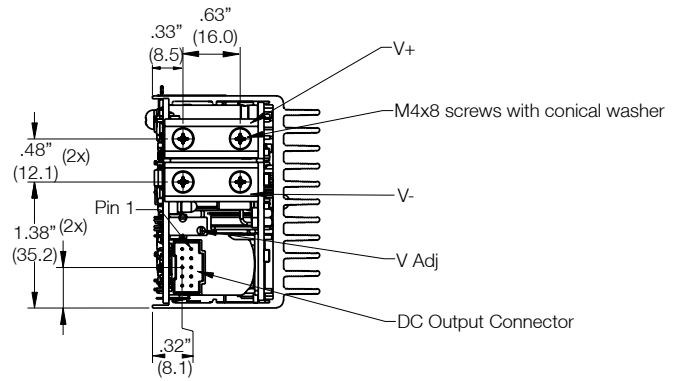

Single 750 Watt

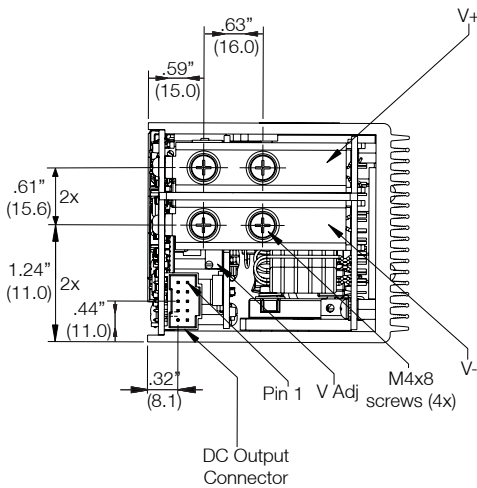

Single 1500 Watt

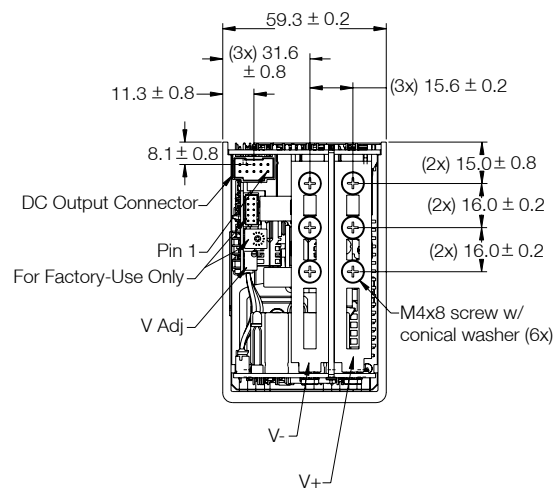

Dual 144 Watt

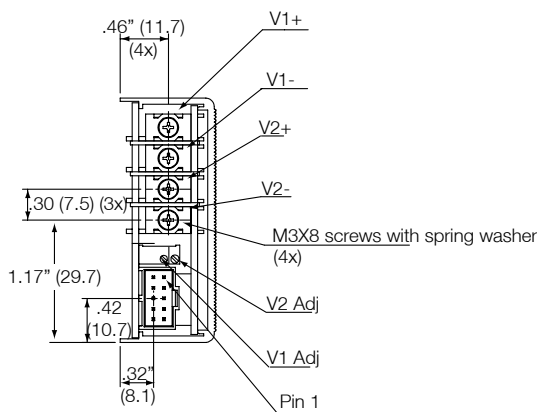

Triple 36 Watt

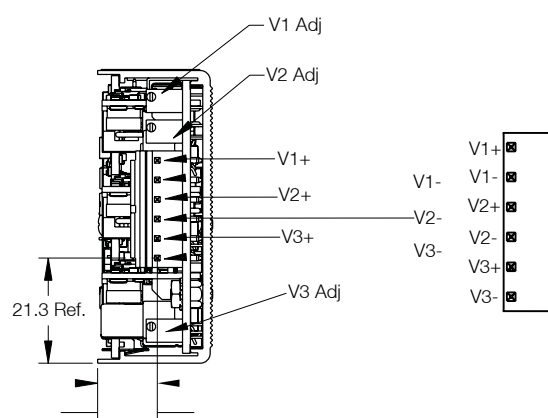

Notes:

1. Output Module Connections: All single O/P modules are M4 x 8 mm screws. Maximum torque: 10 in.-lbs. (1.13 N-m). Dual O/P module is M3 x 8 mm screws. Maximum torque: 5 in.-lbs. (0.57 N-m).
2. All output modules have a green DC OK LED, (except for 36 W module).
3. See Connectors Table 4 for mating connector kits.

Non-Intelligent Modules Dimensional Drawings – in. (mm)

Single 210 Watt

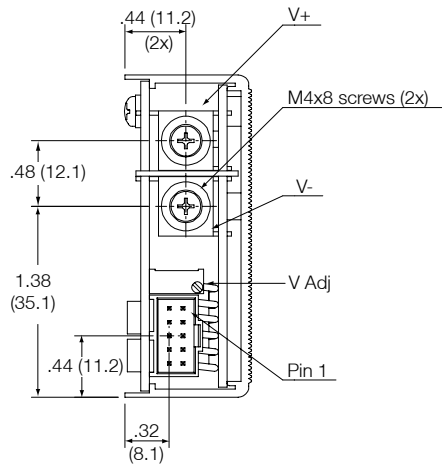

Single 360 Watt

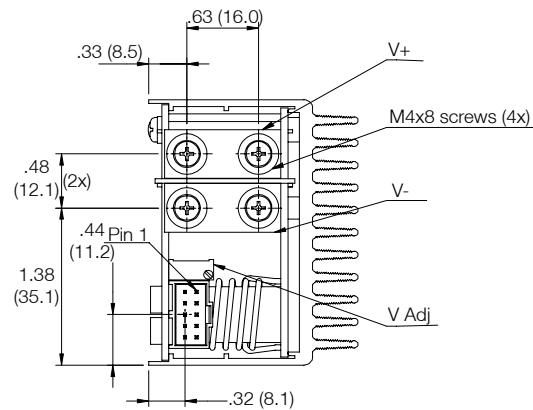

Notes:

1. Output Module Connections: All single O/P modules are M4 x 8 mm screws. Maximum torque: 10 in.-lbs. (1.13 N-m).
Dual O/P module is M3 x 8 mm screws. Maximum torque: 5 in.-lbs. (0.57 N-m).
2. All output modules have a green DC OK LED, (except for 36 W module).
3. See Connectors Table 4 for mating connector kits.

Non-Intelligent Modules Dimensional Drawings – in. (mm)

Single 600 Watt

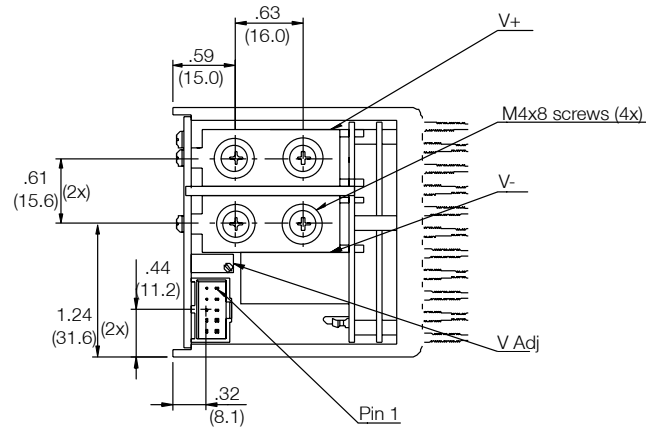

Dual 144 Watt

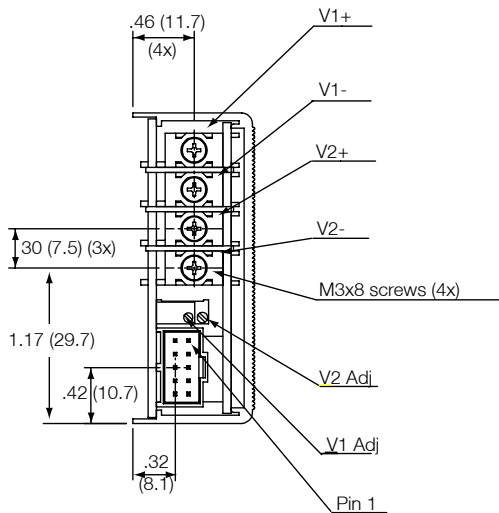

Triple 36 Watt

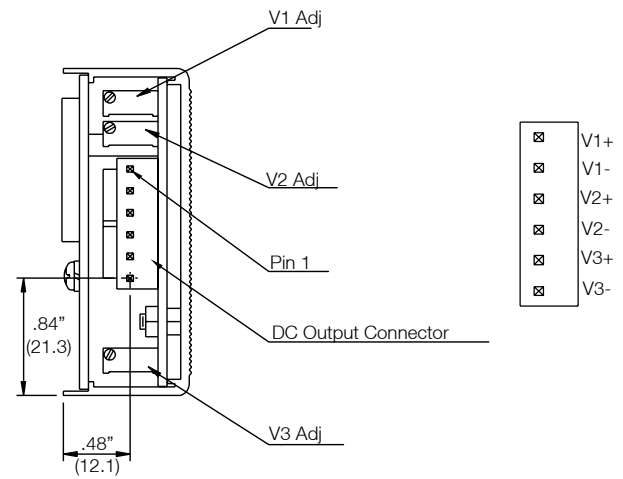

Notes:

1. Output Module Connections: All single O/P modules are M4 x 8 mm screws. Maximum torque: 10 in.-lbs. (1.13 N-m).
Dual O/P module is M3 x 8 mm screws. Maximum torque: 5 in.-lbs. (0.57 N-m).
2. All output modules have a green DC OK LED, (except for 36 W module).
3. See Connectors Table 4 for mating connector kits.