



GPS+GSM+WIFI Combination Antenna thick patch

AN_GPS_GSM_WF_056LM_Adhesive



Mechanical dimension

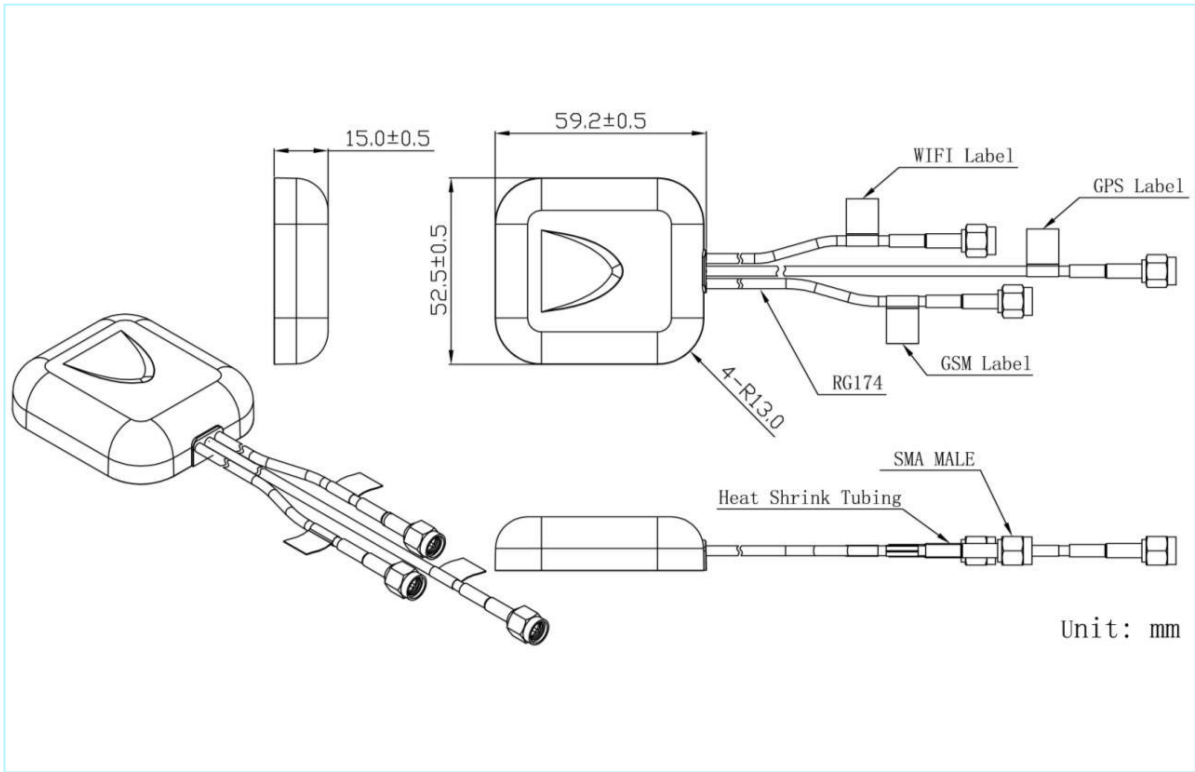

GPS+GSM+WIFI Combination Antenna thick patch

Specifications

| Item | | Specifications | |
|--------------|--------------------|----------------------------|-----------------------------|
| GPS Antenna | Dielectric Antenna | Center Frequency | 1575.42±3MHz |
| | | Band Width | CF±5MHz |
| | | Polarization | RHCP |
| | | Gain | 2dBic (Zenith) |
| | | V.S.W.R | <1.5 |
| | | Impedance | 50Ω |
| | LNA | Gain | 28±2dB |
| | | Noise Figure | <1.5dB |
| | | Ex-band Attenuation | 12dB@CF+50MHz/16dB@CF-50MHz |
| | | V.S.W.R | <2.0 |
| | | Supply Voltage | 2.2~5V DC |
| | | Current Consumption | <15mA |
| GSM Antenna | Frequency Range | 824~960MHz/1710~2170MHz | |
| | V.S.W.R | <2.0(min) | |
| | Polarization | Linear | |
| | Gain | 2.0dBi | |
| | Impedance | 50Ω | |
| WIFI Antenna | Frequency Range | 2400~2483.5MHz | |
| | Band Width | 83.5MHz | |
| | Polarization | Linear | |
| | Gain | 3dBi | |
| | V.S.W.R | <2.0(min) | |
| | Impedance | 50Ω | |
| Mechanical | Cable | 5 meters | |
| | Connector | SMA male for all the leads | |
| | Material | ABS | |
| | Mounting Method | Adhesive | |



GPS+GSM+WIFI Combination Antenna thick patch

Specifications

| | | |
|---------------|--------------------------|---|
| Environmental | Operating Temperature | -40°C~+85°C |
| | Relative Humidity | Up to 95% |
| | Ingress Protection | IP65~IP66(exclude cable outlet) |
| | Vibration | 10 to 55Hz with 1.5mm amplitude 2hours |
| | Environmentally Friendly | ROHS Compliant |

GPS+GSM+WIFI Combination Antenna thick patch

Radiation Patterns

GPS part Pattern

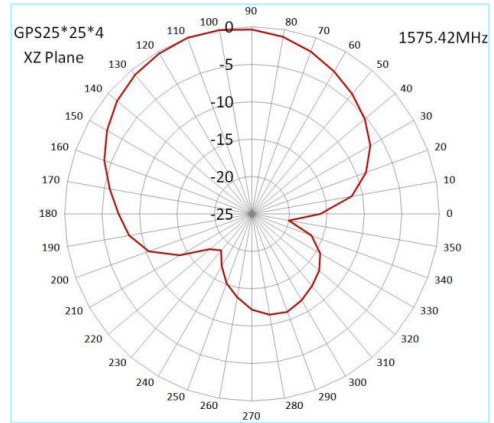
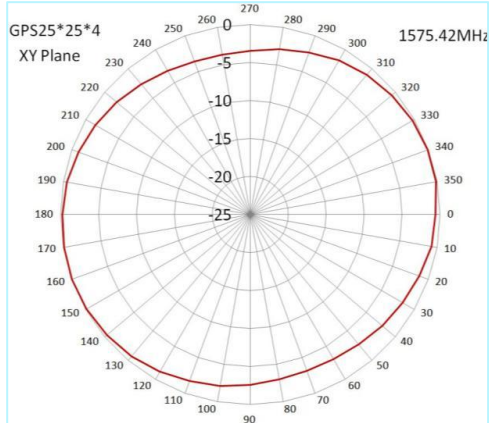

GSM Part Pattern

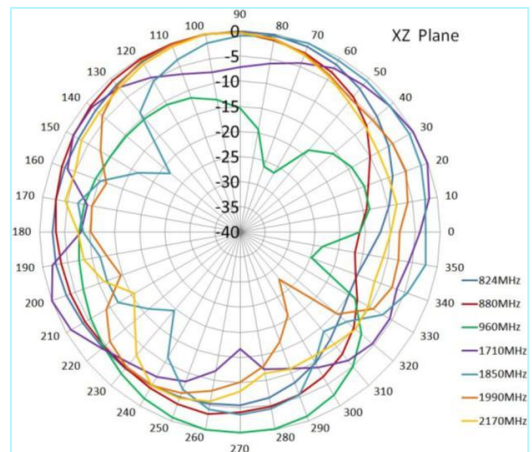
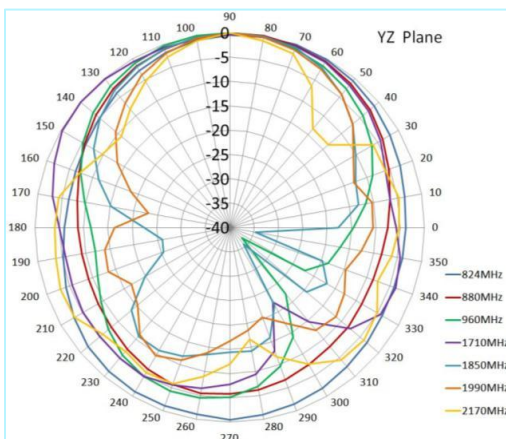
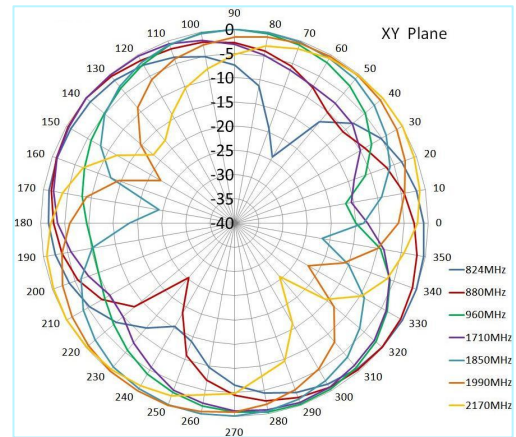
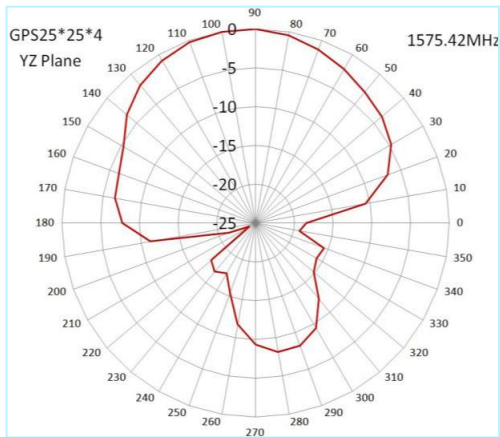

GPS+GSM+WIFI Combination Antenna thick patch

Radiation Patterns

WIFI part Pattern

