

Data sheet | Item number: 2092-3355

1-conductor THT female connector angled; push-button; Push-in CAGE CLAMP®; 2.5 mm²; Pin spacing 7.5 mm; 5-pole; 1.4 mm Ø solder pin; Gripping plate; 2,50 mm²; light gray

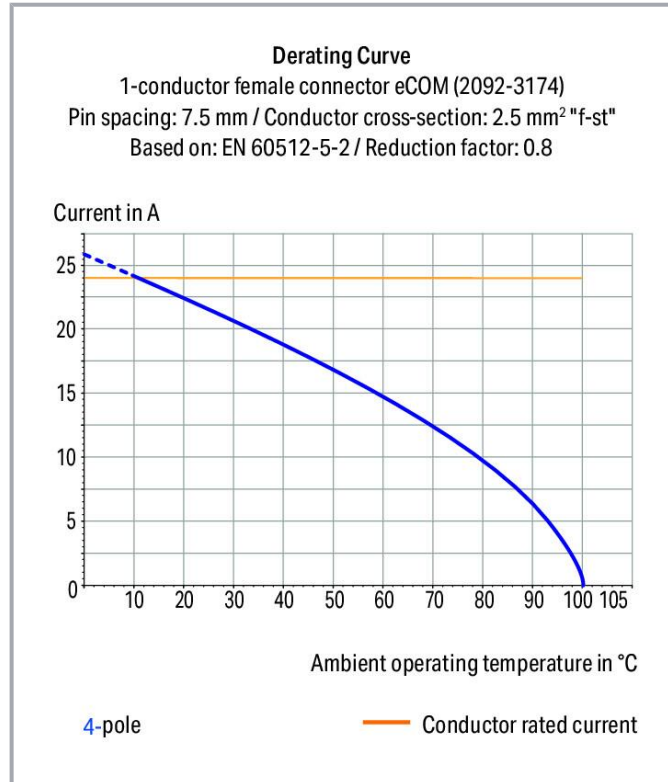

www.wago.com/2092-3355

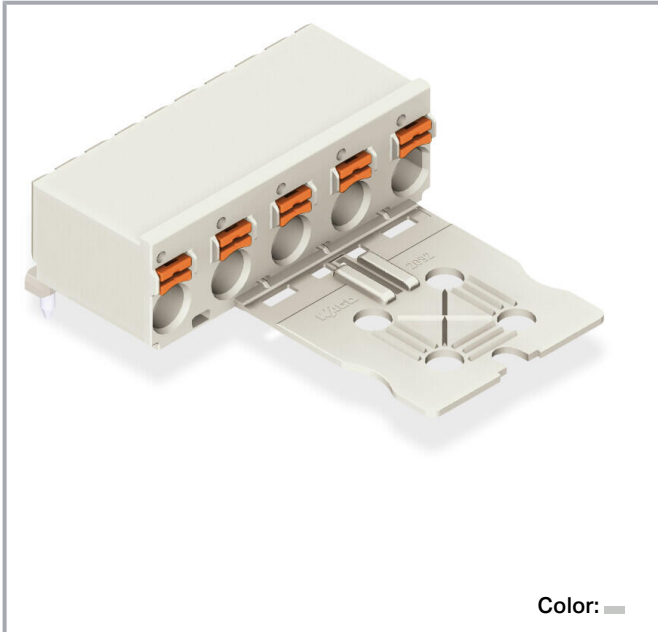

Subject to changes. Please also observe the further product documentation!

WAGO GmbH & Co. KG
Hansastr. 27
32423 Minden
Phone: +49571 887-0 | Fax: +49571 887-169
Email: info.de@wago.com | Web: www.wago.com

Do you have any questions about our products?
We are always happy to take your call at +49 (571) 887-44222.

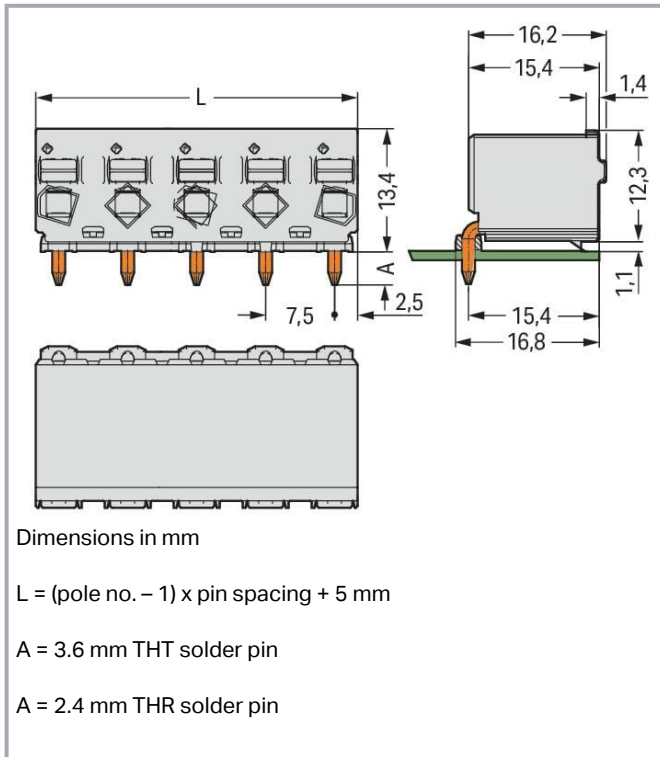

Item description

- Universal connection for all conductor types
- Simple, push-in termination of solid and ferruled conductors
- Easy-to-use design does not require special tools
- Ability to wire while mated or unmated
- Integrated test ports for testing parallel to conductor entry
- Custom-installed solder pins

Data

Notes

Safety information

The **picoMAX® Pluggable Connection System** includes connectors without breaking capacity in accordance with DIN EN 61984. When used as intended, these connectors must not be connected /disconnected when live or under load. The circuit design should ensure header pins, which can be touched, are not live when unmated.

Electrical data

Subject to changes. Please also observe the further product documentation!

WAGO GmbH & Co. KG
 Hansastr. 27
 32423 Minden
 Phone: +49571 887-0 | Fax: +49571 887-169
 Email: info.de@wago.com | Web: www.wago.com

Do you have any questions about our products?
 We are always happy to take your call at +49 (571) 887-44222.



Ratings per IEC/EN

| | |
|-------------------------------|---|
| Ratings per | IEC/EN 60664-1 |
| Nominal voltage (III/3) | 400 V |
| Rated impulse voltage (III/3) | 6 kV |
| Rated voltage (III/2) | 630 V |
| Rated impulse voltage (III/2) | 6 kV |
| Nominal voltage (II/2) | 1000 V |
| Rated surge voltage (II/2) | 6 kV |
| Rated current | 16 A |
| Legend (ratings) | (III / 2) $\hat{=}$ Overvoltage category III / Pollution degree 2 |

Ratings per UL 1059

| | |
|--------------------------------|---------|
| Approvals per | UL 1059 |
| Rated voltage UL (Use Group B) | 300 V |
| Rated current UL (Use Group B) | 15 A |
| Rated voltage UL (Use Group D) | 300 V |
| Rated current UL (Use Group D) | 10 A |

Connection data

| | |
|----------------------------|---|
| Connection points | 5 |
| Total number of potentials | 5 |
| Number of connection types | 1 |
| Number of levels | 1 |

Connection 1

| | |
|---|---|
| Connection technology | Push-in CAGE CLAMP® |
| Actuation type | Push-button |
| Actuation direction 1 | Operation parallel to conductor entry |
| Solid conductor | 0.2 ... 2.5 mm ² / 24 ... 12 AWG |
| Fine-stranded conductor | 0.2 ... 2.5 mm ² / 24 ... 12 AWG |
| Fine-stranded conductor; with insulated ferrule | 0.25 ... 1.5 mm ² |
| Fine-stranded conductor; with uninsulated ferrule | 0.25 ... 2.5 mm ² |
| Strip length | 9 ... 10 mm / 0.35 ... 0.39 inches |
| Conductor connection direction to PCB | 0° |
| Pole number | 5 |

Subject to changes. Please also observe the further product documentation!



Physical data

| | |
|--------------------------------------|--------------------------|
| Pin spacing | 7.5 mm / 0.295 inches |
| Width | 35 mm / 1.378 inches |
| Height | 13.4 mm / 0.528 inches |
| Depth | 40.4 mm / 1.591 inches |
| Solder pin length | 3.6 mm |
| Solder pin diameter | 1.4 mm |
| Drilled hole diameter with tolerance | 1.6 ^(+0.1) mm |

Mechanical Data

| | |
|--------------------------|---------------------|
| Variable coding | No |
| Design | With gripping plate |
| Anti-rotation protection | Yes |

Plug-in connection

| | |
|--------------------------------------|-------------------------|
| Contact type (pluggable connector) | Female connector/socket |
| Connector (connection type) | for PCB |
| Mismating protection | No |
| Plugging without loss of pin spacing | Yes |
| Mating direction to the PCB | 0° |
| Locking of plug-in connection | none |

PCB contact

| | |
|-------------|-----|
| PCB contact | THT |
|-------------|-----|

Material Data

| | |
|-----------------------------|--|
| Note (material data) | Information on material specifications can be found here |
| Color | light gray |
| Material group | I |
| Insulation material | Polyphthalamide (PPA GF) |
| Flammability class per UL94 | V0 |
| Clamping spring material | Chrome-nickel spring steel (CrNi) |
| Contact material | Electrolytic copper (E _{Cu}) |

Subject to changes. Please also observe the further product documentation!

| | |
|-----------------|----------|
| Contact plating | Tin |
| Fire load | 0.026 MJ |
| Weight | 7.9 g |

Environmental requirements

| | |
|-------------------------|-----------------|
| Limit temperature range | -60 ... +100 °C |
| Processing temperature | -35 ... +60 °C |

Commercial data



| | |
|-----------------------|-------------------------|
| Product Group | 26 (picoMAX Connectors) |
| eCl@ss 10.0 | 27-44-04-02 |
| eCl@ss 9.0 | 27-44-04-02 |
| ETIM 8.0 | EC002637 |
| ETIM 7.0 | EC002637 |
| PU (SPU) | 100 pcs |
| Packaging type | box |
| Country of origin | DE |
| GTIN | 4050821165453 |
| Customs tariff number | 85366990990 |

Environmental Product Compliance



| | |
|------------------------|-------------------------|
| RoHS Compliance Status | Compliant, No Exemption |
|------------------------|-------------------------|

Approvals / Certificates

General approvals

| Logo | Approval | Additional Approval Text | Certificate name |
|--|---|--------------------------|------------------|
|  | CSA DEKRA Certification B.V. | C22.2 No. 158 | 2362521 |
|  | CSA DEKRA Certification B.V. | C22.2 | 2362521 |
|  | cURus Underwriters Laboratories Inc. | UL 1059 | E45172 |

Subject to changes. Please also observe the further product documentation!

| | | | |
|--|--|----------|------------------------|
|  | KEMA/KEUR DEKRA Certification B.V. | EN 61984 | 71- 102261 REV.2 |
|  | UL Underwriters Laboratories Inc. | UL 1977 | E45171 |

Downloads

Documentation

Additional Information

| | | | |
|------------------------|------------|---------------|----------|
| Technical Section | 2019 Apr 3 | pdf 2.0 MB | Download |
| Technical explanations | | | |

CAD/CAE-Data

PCB Design

| | | |
|--------------------------------|-----|----------|
| Symbol and Footprint 2092-3355 | URL | Download |
|--------------------------------|-----|----------|

CAX data for your PCB design, consisting of "schematic symbols and PCB footprints", allow easy integration of the WAGO component into your development environment.

Supported formats:

- Accel EDA 14 & 15
- Altium 6 to current version
- Cadence Allegro
- DesignSpark
- Eagle Libraries
- KiCad
- Mentor Graphics BoardStation
- Mentor Graphics Design Architect
- Mentor Graphics Design Expedition 99 and 2000
- OrCAD 9.X PCB and Capture
- PADS PowerPCB 3, 3.5, 4.X, and 5.X
- PADS PowerPCB and PowerLogic 3.0
- PCAD 2000, 2001, 2002, 2004, and 2006

—
Subject to changes. Please also observe the further product documentation!

- Pulsonix 8.5 or newer
- STL
- 3D STEP
- TARGET 3001!
- View Logic ViewDraw
- Quadcept
- Zuken CadStar 3 and 4
- Zuken CR-5000 and CR-8000

PCB Component Libraries (EDA), PCB CAD Library Ultra Librarian

Environmental Product Compliance

Compliance Search

Environmental Product Compliance 2092-3355

[URL](#)

[Download](#)

1-conductor THT female connector angled; push-button; Push-in CAGE CLAMP®; 2.5 mm²; Pin spacing 7.5 mm; 5-pole; 1.4 mm Ø solder pin; Gripping plate; 2,50 mm²; light gray

Installation Notes

Conductor termination

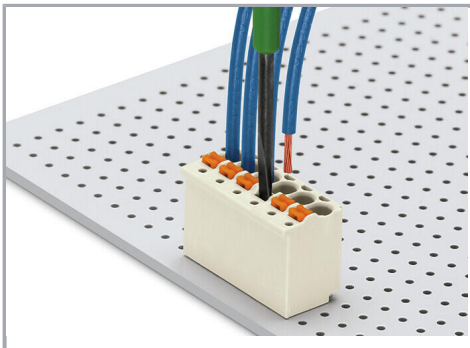

Terminating fine-stranded conductors and removing all conductor types via push-buttons.

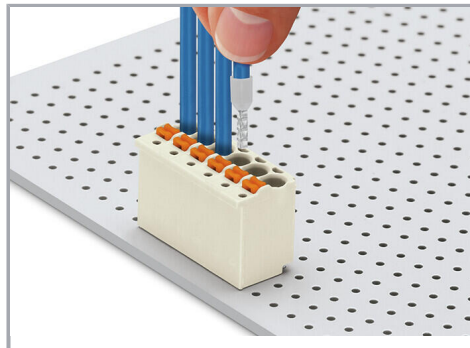

Solid and ferruled conductors are terminated by simply pushing them into unit.

Marking

Subject to changes. Please also observe the further product documentation!

WAGO GmbH & Co. KG
Hansastr. 27
32423 Minden
Phone: +49571 887-0 | Fax: +49571 887-169
Email: info.de@wago.com | Web: www.wago.com

Do you have any questions about our products?
We are always happy to take your call at +49 (571) 887-44222.



Pole marking via direct marking perpendicular to conductor entry.



Pole marking via factory direct marking.

Testing

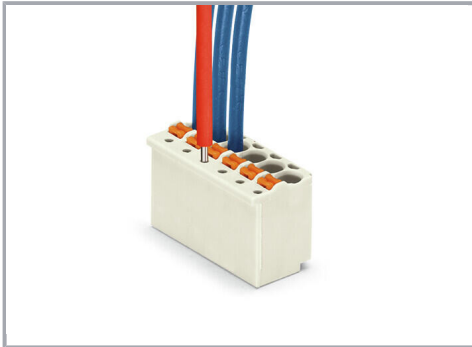

Testing via 1 mm Ø test pin – touch contact.

Subject to changes. Please also observe the further product documentation!