

FEMALE PLUG M12 STRAIGHT TO MALE PLUG M12 STRAIGHT

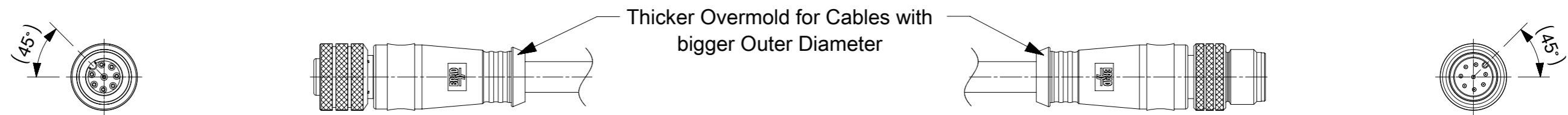
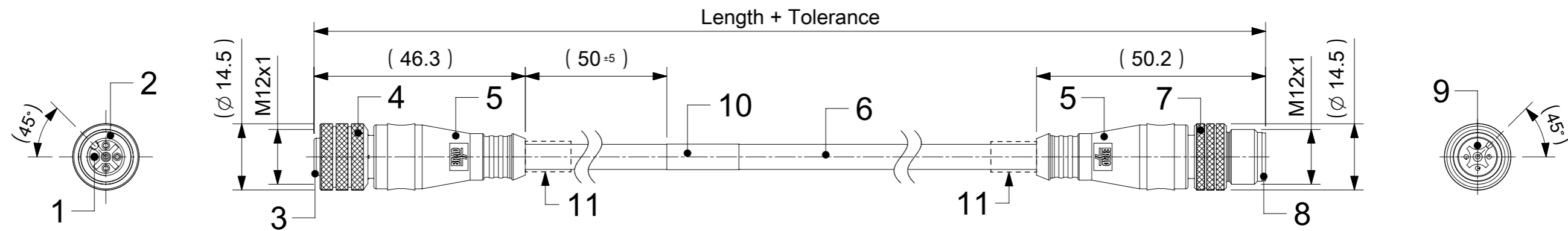

NOTES:

- RATED VOLTAGE: 3, 4 contacts 250V per IEC 60664
- 5 contacts 60V per IEC 60664
- 5 contacts 250V per UL 2238
- 8 contacts 30V per IEC 60664
- RATED CURRENT: 3, 4, 5 contacts 4A
- 8 contacts 2A

PROTECTION CLASS: IP 67
 TEMPERATURE: -25°C / +85°C
 CONTACTS POSITION FRONT VIEW:

	3 CONTACTS		4 CONTACTS		5 CONTACTS		8 CONTACTS	
FEMALE								
MALE								
CONNECTIONS	PIN	WIRE	PIN	WIRE	PIN	WIRE	PIN	WIRE
	1	BROWN	1	BROWN	1	BROWN	1	WHITE
	2	---	2	WHITE	2	WHITE	2	BROWN
	3	BLUE	3	BLUE	3	BLUE	3	GREEN
	4	BLACK	4	BLACK	4	BLACK	4	YELLOW
	5	---	5	---	5	GREY OR GREEN/YELLOW	5	GREY
							6	PINK
							7	BLUE
						8	RED	

CODING REQUIRED TO IEC 61076-2-101

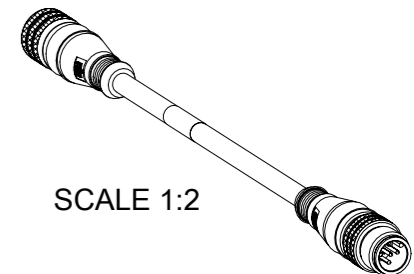

SCALE 1:2

FOR OPTIONS SEE - NUMERICAL CODE - ON SHEET 2

ITEM	QTY.	DESCRIPTION	MATERIAL	FINISH
11	SEE SHEET 2	ID CARRIER	PVC	TRANSPARENT
10	1	LABEL YELLOW	VINYL	---
	-	PRINTING FOR CABLES lxx	---	---
9	3 / 4 / 5 / 8	CONTACT MALE	SEE PART LIST	SELECTIVE Au OVER Ni
8	1	INSERT MALE BLACK	TPU	---
7	1	COUPLING NUT MALE	---	---
6	-	CABLE	SEE SHEET 2	---
5	-	OVERMOLDING BLACK	TPU	---
4	1	COUPLING NUT FEMALE	---	---
3	1	INSERT FEMALE BLACK	PUR	---
2	1	ORING RED	FPM	---
1	3 / 4 / 5 / 8	CONTACT FEMALE	SEE PART LIST	SELECTIVE Au OVER Ni

THIS DRAWING CONTAINS INFORMATION THAT IS PROPRIETARY TO MOLEX ELECTRONIC TECHNOLOGIES, LLC AND SHOULD NOT BE USED WITHOUT WRITTEN PERMISSION

DIMENSION UNITS: mm SCALE: 1:1

GENERAL TOLERANCES (UNLESS SPECIFIED):

ANGULAR TOL ± 1.0°

4 PLACES ±

3 PLACES ±

2 PLACES ± 0.05

1 PLACE ± 0.3

0 PLACES ± 0.5

DRAFT WHERE APPLICABLE MUST REMAIN WITHIN DIMENSIONS

THIRD ANGLE PROJECTION

DRAWING: A3-SIZE

SERIES: 120066

MATERIAL NUMBER: SEE PART LIST

CUSTOMER: GENERAL MARKET

SHEET NUMBER: 1 OF 4

EC NO: 734641

DRWN: RSCHIEBER 2022/12/01

CHK'D: RSILLER 2023/01/12

APPR: RSILLER 2023/01/12

INITIAL REVISION:

DRWN: JMARSZALEK 2016/09/19

APPR: RSILLER 2016/12/08

DOCUMENT NUMBER: 1200668165

DOC TYPE: PSD

DOC PART: 000

REVISION: A6

PRODUCT CUSTOMER DRAWING

ENGINEERING NO. - NUMERICAL CODE (Available parts see PART LIST table. Other parts available upon request).

8 8 X 0 3 0 X X X X X X X X

OPTIONS

88=Micro-Change
M12x1
Double ended

Contacts:
3=3 Contacts
4=4 Contacts
5=5 Contacts
8=8 Contacts

Heads style:
030=Plug Female Straight
to Plug Male Straight

Cable type: See Table

Units:
M=Meter

Length
Examples:
005=0.5 unit
010=1 unit
100=10 units

Coupling Nut:
Blank (Standard)=Knurled Brass Ni Plated
1=Hexagonal Stainless steel
5=Knurled Derlin
7=Knurled Brass Ni Plated, Teflon Coated
Blank=7 for cables I20, I26, K03, K05, P82, S26
8=Type 316 stainless steel
9=Knurled / Hexagonal Brass Ni Plated SW13

H= 2 pcs. of I/D Carrier PVC Transparent
(Cables Ixx & P82 always with 2 pcs. of I/D Carrier even if no H in Engineering No.)

Overmold color:
Blank (Standard)=Black TPU
Blank=Yellow PVC for cables
A09, S19, S20, S26
Blank=Yellow TPE-E for cables
K03, K05
A=Grey / G=Black / Y=Yellow

COUPLING NUT
FEMALE MALE

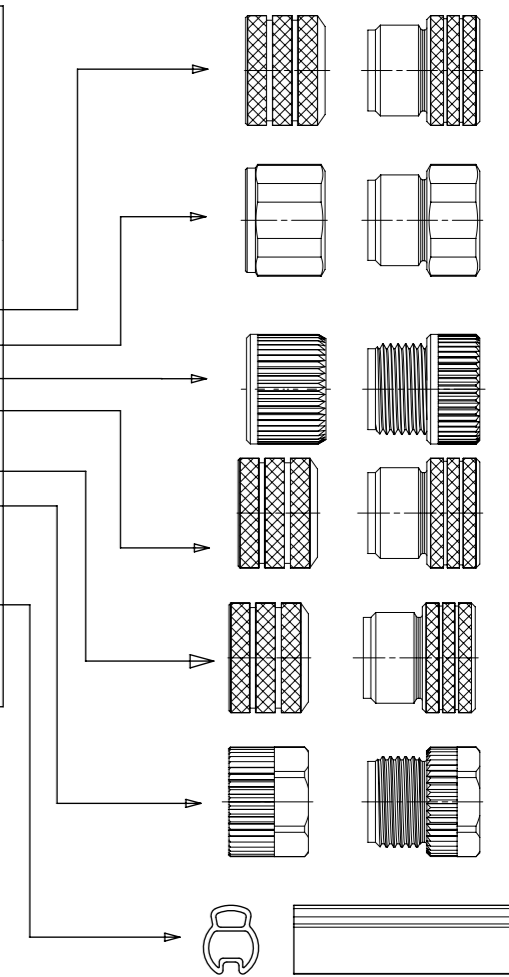

CABLE LENGTH TOLERANCES		
OVER [mm]	UP TO AND INCLUDING [mm]	TOLERANCES [mm]
0	305	+19
305	915	+45
915	1830	+56
1830	3660	+89
3660	7320	+165
7320	14640	+317
14640	30500	+610
30500	>	+2% OF FINISHED LENGTH

THIS DRAWING CONTAINS INFORMATION THAT IS PROPRIETARY TO MOLEX ELECTRONIC TECHNOLOGIES, LLC AND SHOULD NOT BE USED WITHOUT WRITTEN PERMISSION									
DIMENSION UNITS	SCALE	CURRENT REV DESC: NEW P/N ADDED							
mm	1:1								
GENERAL TOLERANCES (UNLESS SPECIFIED)									
ANGULAR TOL	± 1.0 °	CSE M12 XP AC FE STR MA STR XM DE							
4 PLACES	±	PRODUCT CUSTOMER DRAWING							
3 PLACES	±	DOCUMENT NUMBER							
2 PLACES	± 0.05	1200668165							
1 PLACE	± 0.3	DOC TYPE DOC PART REVISION							
0 PLACES	± 0.5	PSD 000 A6							
DRAFT WHERE APPLICABLE MUST REMAIN WITHIN DIMENSIONS		THIRD ANGLE PROJECTION	DRAWING	SERIES	MATERIAL NUMBER	CUSTOMER		SHEET NUMBER	
			A3-SIZE	120066	SEE PART LIST	GENERAL MARKET		2 OF 4	

CABLE INFORMATION (for more information see Cable Data Sheet).

CABLE TYPE	NO. OF WIRES	CROSS SECTION	CABLE JACKET	UL	CSA	STATIC: TEMP. / BENDING RADIUS	DYNAMIC: TEMP. / BENDING RADIUS	DRAG CHAIN	SHIELD
A09	4	22AWG	PVC YELLOW	UL 2661	I/II A/B 80°C/300V	-	-	-	-
B02	4	18AWG	PUR YELLOW	UL 20549	I/II A/B 80°C/300V	-	-	-	-
E52	3 / 4	0.34mm ²	PVC GREY	-	-	-30°C to +70°C	-5°C to +70°C	-	-
E57	5	0.34mm ²	PVC GREY	-	-	-	-5°C to +70°C	-	-
I02	3 / 4 / 8	0.25mm ²	PVC CEI GREY	-	-	-30°C to +70°C	-5°C to +70°C	-	-
I03	3 / 4 / 5	0.34mm ²	PVC CEI GREY	-	-	-30°C to +70°C	-5°C to +70°C	-	-
I20	3 / 4	0.34mm ²	PVC CEI GREY	-	-	-30°C to +70°C	-5°C to +70°C	-	YES
I26	5	0.34mm ²	PVC CEI GREY	-	-	-30°C to +70°C	-5°C to +70°C	-	YES
K03	4 / 5	18AWG	TPE YELLOW	UL ITC or PLC	I/II A/B 90°C/300V	max 105°C	-	-	-
K05	3 / 4 / 5	22AWG	TPE YELLOW	UL ITC or PLTC	I/II A/B 90°C/300V	max 105°C	-	-	-
P04	4	0.50mm ²	PUR BLACK	-	-	-40°C to +90°C, >7.5xO.D.	-15°C to +90°C, >12.5xO.D.	-	-
P19	8	0.25mm ²	PUR BLACK	-	-	-40°C to +90°C, >7.5xO.D.	-15°C to +90°C, >12.5xO.D.	2 000 000 cycles, >15xO.D.	YES
P20	3 / 4 / 5	0.34mm ²	PUR BLACK LS0H	-	-	-30°C to +80°C	-	-	YES
P82	3 / 4 / 5	0.34mm ²	PUR IRR ORANGE	-	-	-50°C to +105°C, >5xO.D.	-40°C to +105°C, >7.5xO.D.	-	-
S19	8	0.25mm ²	PVC YELLOW	UL 2661/1569	C22.2 II A 105°C/300V	-30°C to +105°C, >10xO.D.	-15°C to +105°C, >15xO.D.	-	YES
S20	3 / 4 / 5	0.34mm ²	PVC YELLOW	UL 2661/1731	C22.2 II A 105°C/300V	-30°C to +105°C	-	-	YES
S26	5	0.34mm ²	PVC YELLOW	UL 2661/1731	C22.2 II A 105°C/300V	-30°C to +105°C	-	-	YES

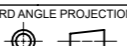
THIS DRAWING CONTAINS INFORMATION THAT IS PROPRIETARY TO MOLEX ELECTRONIC TECHNOLOGIES, LLC AND SHOULD NOT BE USED WITHOUT WRITTEN PERMISSION									
DIMENSION UNITS	SCALE	CURRENT REV DESC: NEW P/N ADDED							
mm	1:1								
GENERAL TOLERANCES (UNLESS SPECIFIED)									
ANGULAR TOL	± 1.0 °	EC NO: 734641 DRWN: RSCHIEBER 2022/12/01 CHK'D: RSILLER 2023/01/12 APPR: RSILLER 2023/01/12							
4 PLACES	±								
3 PLACES	±	PRODUCT CUSTOMER DRAWING							
2 PLACES	± 0.05								
1 PLACE	± 0.3	INITIAL REVISION:				DOCUMENT NUMBER	DOC TYPE	DOC PART	REVISION
0 PLACES	± 0.5	DRWN: JMARSZALEK 2016/09/19 APPR: RSILLER 2016/12/08				1200668165	PSD	000	A6
DRAFT WHERE APPLICABLE MUST REMAIN WITHIN DIMENSIONS		THIRD ANGLE PROJECTION	DRAWING	SERIES	MATERIAL NUMBER	CUSTOMER		SHEET NUMBER	
			A3-SIZE	120066	SEE PART LIST	GENERAL MARKET		3 OF 4	

DOCUMENT STATUS	P1	RELEASE DATE	2023/01/12	11:47:32
-----------------	----	--------------	------------	----------

PART LIST

No.	Part No.	Engineering No.	Cable Length
1	1200070023	884030S20M060H	6m
2	1200070095	883030I03M003	0.3m
3	1200070096	883030I03M006	0.6m
4	1200070097	883030I03M010	1m
5	1200070098	883030I03M020	2m
6	1200070099	883030I03M030	3m
7	1200070100	883030I03M050	5m
8	1200070101	883030I03M100	10m
9	1200070110	883030S20M010	1m
10	1200070111	883030S20M020	2m
11	1200070480	884030I03M010	1m
12	1200070481	884030I03M020	2m
13	1200070483	884030I03M050	5m
14	1200070484	884030I03M060	6m
15	1200070485	884030I03M100	10m
16	1200070499	884030S20M020	2m
17	1200070500	884030S20M030	3m
18	1200070502	884030S20M050	5m
19	1200070504	884030S20M100	10m
20	1200070597	885030S26M010	1m
21	1200070653	884030E52M200A	20m
22	1200070774	884030I03M006	0.6m
23	1200070785	884030I03M030	3m
24	1200070867	884030E52M100A	10m
25	1200070890	885030I26M010	1m
26	1200070891	885030I26M020	2m
27	1200070892	885030I26M030	3m
28	1200070956	883030E52M020A	2m
29	1200070961	885030I03M030	3m
30	1200071026	884030E52M010A	1m
31	1200071035	884030S20M010H	1m
32	1200071137	884030S20M030H	3m
33	1200071141	884030S20M020H	2m
34	1200071161	884030S20M100H	10m
35	1200071178	884030S20M006H	0.6m
36	1200071188	884030S20M050H	5m
37	1200071237	884030S20M005H	0.5m
38	1200071238	884030S20M015H	1.5m
39	1200071264	884030S20M040H	4m
40	1200071272	884030S20M005	0.5m
41	1200071279	885030I26M050	5m
42	1200071338	884030I20M030	3m
43	1200071343	883030E52M003A	0.3m
44	1200071624	884030E52M030A	3m
45	1200071627	884030I03M0205	2m
46	1200072106	885030I26M005	0.5m
47	1200072359	885030I26M015	1.5m

No.	Part No.	Engineering No.	Cable Length
48	1200660271	884030A09M020	2m
49	1200660273	884030A09M0208	2m
50	1200660277	884030A09M030	3m
51	1200660286	884030A09M0508	5m
52	1200660291	884030A09M070	7m
53	1200660683	884030K05M003	0.3m
54	1200660684	884030K05M005	0.5m
55	1200660686	884030K05M006	0.6m
56	1200660687	884030K05M010	1m
57	1200660688	884030K05M015	1.5m
58	1200660689	884030K05M020	2m
59	1200660690	884030K05M030	3m
60	1200660691	884030K05M040	4m
61	1200660692	884030K05M050	5m
62	1200660693	884030K05M060	6m
63	1200660694	884030K05M080	8m
64	1200660695	884030K05M100	10m
65	1200660696	884030K05M120	12m
66	1200660697	884030K05M150	15m
67	1200660698	884030K05M180	18m
68	1200660699	884030K05M230	23m
69	1200660700	884030K05M300	30m
70	1200660857	884030B02M020	2m
71	1200660860	884030B02M030	3m
72	1200660862	884030B02M050	5m
73	1200660867	884030B02M100	10m
74	1200660878	884030K03M003	0.3m
75	1200660880	884030K03M006	0.6m
76	1200660881	884030K03M010	1m
77	1200660883	884030K03M020	2m
78	1200660887	884030K03M030	3m
79	1200660891	884030K03M040	4m
80	1200660895	884030K03M050	5m
81	1200660898	884030K03M060	6m
82	1200660899	884030K03M070	7m
83	1200660900	884030K03M080	8m
84	1200660901	884030K03M090	9m
85	1200660902	884030K03M100	10m
86	1200660904	884030K03M120	12m
87	1200660905	884030K03M140	14m
88	1200660906	884030K03M150	15m
89	1200660907	884030K03M160	16m
90	1200660909	884030K03M200	20m
91	1200660911	884030K03M250	25m
92	1200660915	884030K05M070	7m
93	1200660918	884030K05M140	14m
94	1200660921	884030K05M200	20m

No.	Part No.	Engineering No.	Cable Length
95	1200660922	884030K05M210	21m
96	1200661034	885030K03M010	1m
97	1200661035	885030K03M020	2m
98	1200661036	885030K03M030	3m
99	1200661038	885030K03M050	5m
100	1200661042	885030K03M090	9m
101	1200661043	885030K03M100	10m
102	1200661044	885030K03M150	15m
103	1200661434	884030E52M020A	2m
104	1200661438	884030K05M250	25m
105	1200661441	884030K05M190	19m
106	1200661472	884030E52M050A	5m
107	1200661543	884030K03M180	18m
108	1200661574	888030S19M120	12m
109	1200661575	888030S19M030	3m
110	1200661576	888030S19M050	5m
111	1200661577	888030S19M100	10m
112	1200661664	885030K03M005	0.5m
113	1200661685	885030K03M120	12m
114	1200661906	884030K03M500	50m
115	1200665012	885030P82M0307	3m
116	1200665368	884030K05M280	28m
117	1200668001	884030K03M110	11m
118	1200668003	884030K03M005	0.5m
119	1200668004	884030K03M240	24m
120	1200668068	884030S20M010	1m
121	1200668082	885030I26M006	0.6m
122	1200668090	885030S26M020H	2m
123	1200668165	885030I03M100	10m
124	1200668172	883030S20M050	5m
125	1200668281	885030I26M025	2.5m
126	1200668310	883030S20M005	0.5m
127	1200668371	883030I03M040	4m
128	1200668372	884030I03M040	4m
129	1200668505	884030P20M010	1m
130	1200668506	884030P20M020	2m
131	1200668507	884030P20M050	5m
132	1200668508	884030P20M100	10m

No.	Part No.	Engineering No.	Cable Length
133	1200668615	884030K05M050H	5m
134	1200668616	884030K05M100H	10m
135	1200668632	883030I03M020Y	2m
136	1200668633	883030I03M030Y	3m
137	1200668634	883030I03M050Y	5m
138	1200668637	884030I03M020Y	2m
139	1200668638	884030I03M100Y	10m
140	1200668639	885030I26M010Y	1m
141	1200668640	885030I26M020Y	2m
142	1200668641	885030I26M030Y	3m
143	1200668642	885030I03M030Y	3m
144	1200668736	885030I26M015Y	1.5m
145	1200668773	885030P82M0107	1m
146	1200668873	885030I26M050Y	5m
147	1200669113	884030A09M0308	3m
148	1200669149	883030I03M010Y	1m
149	1200669218	885030I03M100Y	10m
150	1200669227	884030K05M500	50m
151	1200669228	884030K05M600	60m
152	1200660166	883030A09M010	1m
153	1200660261	884030A09M005	0.5m
154	1200660262	884030A09M006	0.6m
155	1200660266	884030A09M010	1m
156	1200660269	884030A09M015	1.5m
157	1200660294	884030A09M080	8m
158	1200660299	884030A09M1008	10m
159	1200660434	885030A09M050	5m
160	1200661037	885030K03M040	4m
161	1200661039	885030K03M060	6m
162	1200661041	885030K03M080	8m
163	1200661684	885030K03M300	30m
164	1200661686	885030K03M180	18m
165	1200661687	885030K03M230	23m
166	1200668081	885030E57M100A	10m
167	1200669948	884030K05M032	3.2m

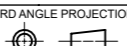
THIS DRAWING CONTAINS INFORMATION THAT IS PROPRIETARY TO MOLEX ELECTRONIC TECHNOLOGIES, LLC AND SHOULD NOT BE USED WITHOUT WRITTEN PERMISSION											
DIMENSION UNITS		SCALE		CURRENT REV DESC: NEW P/N ADDED						CSE M12 XP AC FE STR MA STR XM DE	
mm		1:1									
GENERAL TOLERANCES (UNLESS SPECIFIED)				EC NO: 734641				DOCUMENT NUMBER: 1200668165 DOC TYPE: PSD DOC PART: 000 REVISION: A6			
ANGULAR TOL ± 1.0°				DRWN: RSCHIEBER 2022/12/01							
4 PLACES ±				CHK'D: RSILLER 2023/01/12				PRODUCT CUSTOMER DRAWING			
3 PLACES ±				APPR: RSILLER 2023/01/12							
2 PLACES ± 0.05				INITIAL REVISION:				MATERIAL NUMBER: SEE PART LIST CUSTOMER: GENERAL MARKET SHEET NUMBER: 4 OF 4			
1 PLACE ± 0.3				DRWN: JMARSZALEK 2016/09/19							
0 PLACES ± 0.5				APPR: RSILLER 2016/12/08							
DRAFT WHERE APPLICABLE MUST REMAIN WITHIN DIMENSIONS				THIRD ANGLE PROJECTION		DRAWING		SERIES		MATERIAL NUMBER	
						A3-SIZE		120066		SEE PART LIST	

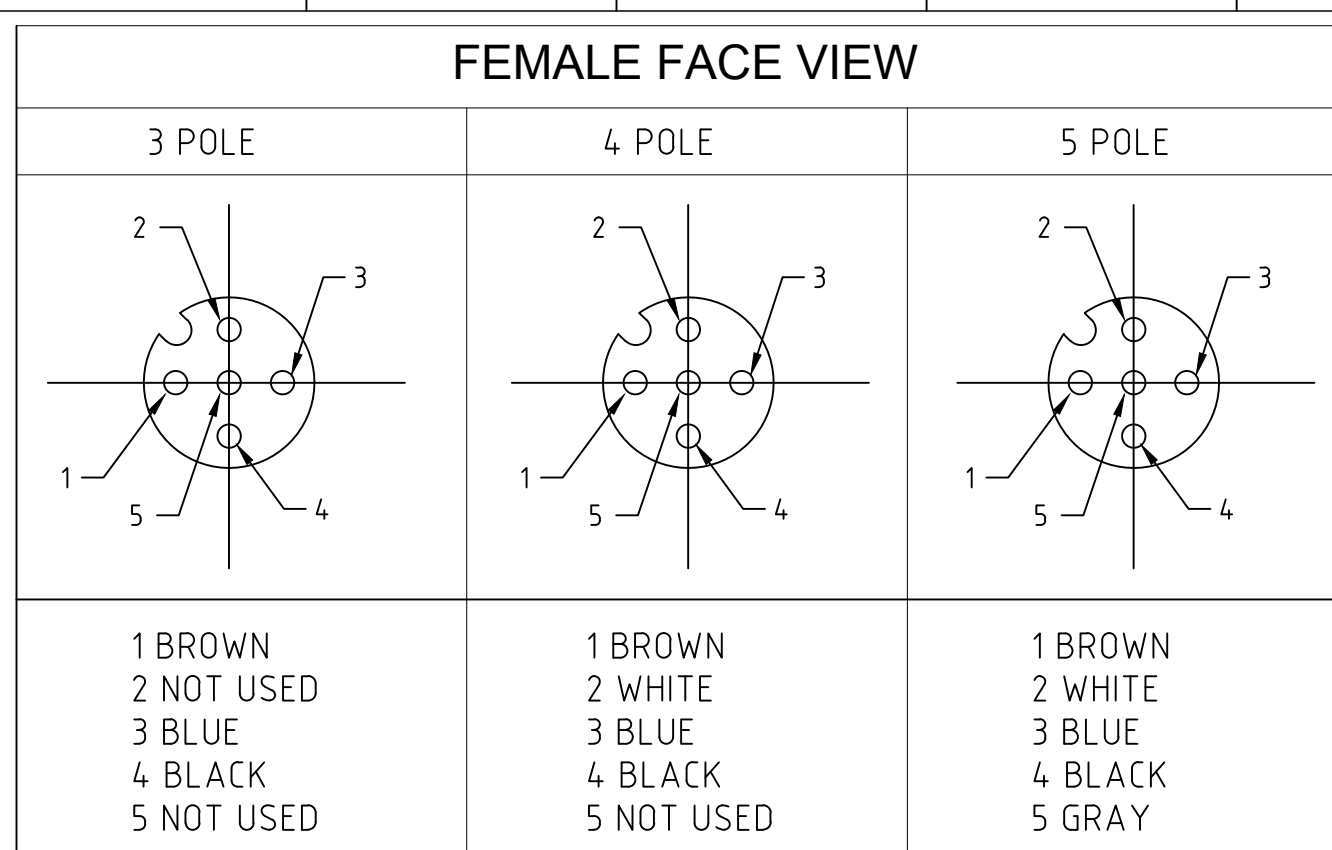

PART NO.	ENGINEERING NO.	FINISHED LENGTH	POLES	CABLE DIA.
1200660677	883030K05M020	2.0M [6'7"]	3	.20/5.1
1200660691	884030K05M040	4.0M [13'1"]	4	.21/5.3
1200662133	885030K05M100	10.0M [32'10"]	5	.23/5.8

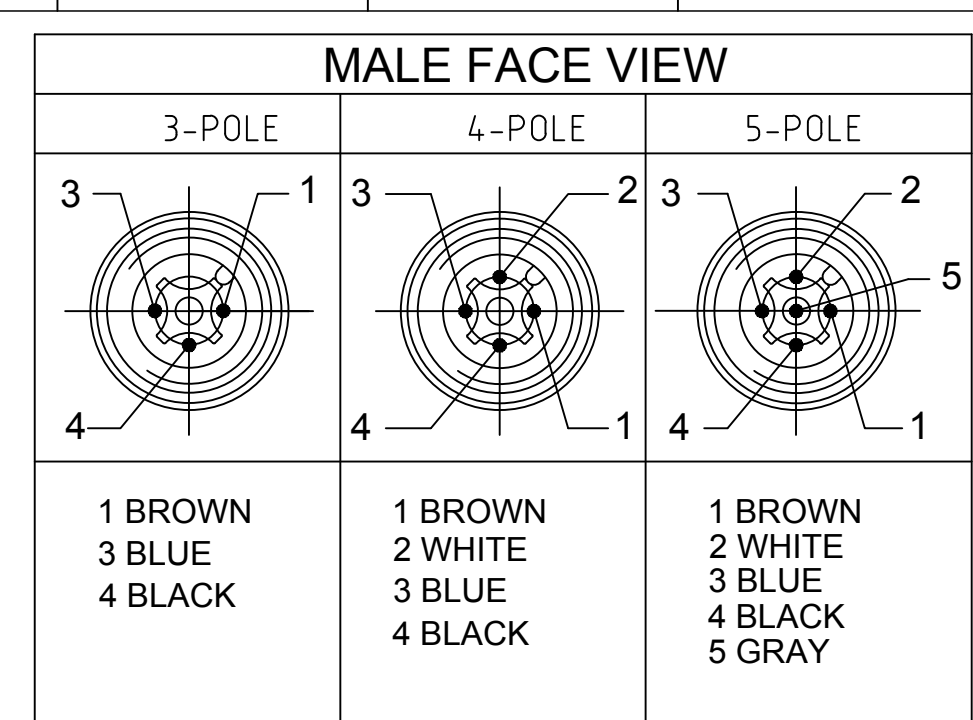

(B) PART NO. LEGEND

883030K05M020

POLES: 3,4 & 5

CABLE TYPE: 22AWG TPE YELLOW

FINISHED LENGTH:
 M005 = 0.5 Meters
 M010 = .0 Meter
 M100 = 10 Meters

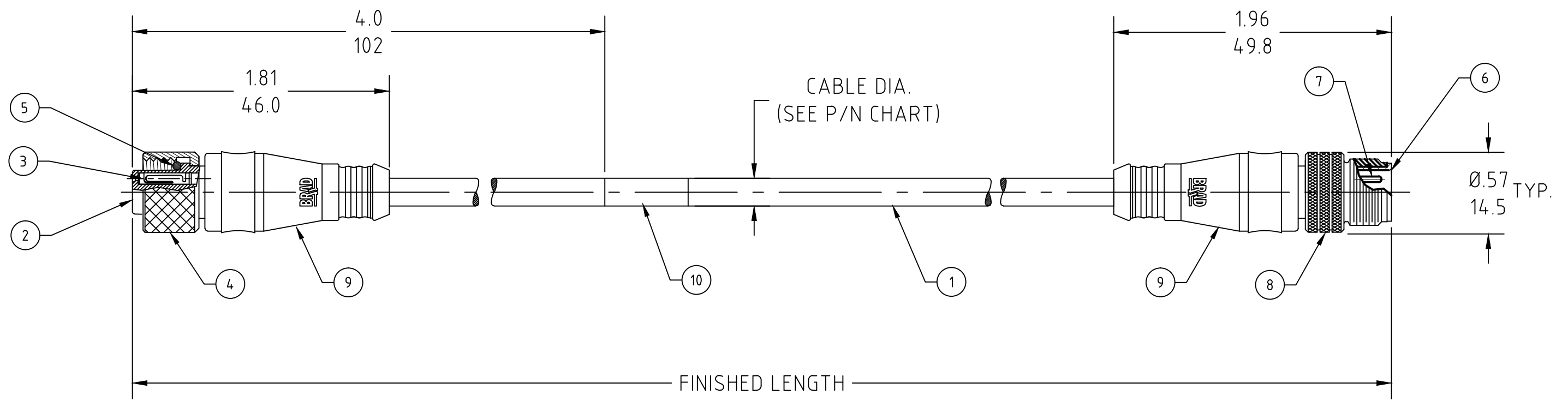

- (B) NOTES:**
- MATERIAL: AS NOTED
 - FINISH: AS NOTED
 - ELECTRICAL:
VOLTAGE: 250V
CURRENT: 4A
 - TEMP RATING: -25°TO +105°C
 - PROTECTION: IP67 (WHEN MATED)
 - COUPLING THREAD: M12 X 1
 - UL RECOGNIZED FILE: E152210
CSA CERTIFIED FILE: LR6837
 - ALL DIMS ARE FOR REFERENCE UNLESS NOTED OTHERWISE

(B) CABLE FLEX CHARACTERISTICS

TORSIONAL FLEX TEST	10 MILLION CYCLES PER MIL-C-13777G
BEND FLEX TEST	10 MILLION CYCLES PER MIL-C-13777G
WELD SLAG RESISTANCE	WOODHEAD STANDARD S-300

(B) CABLE LENGTH TOLERANCES

>.3M [1FT]: +19mm-0 [+1.75in-0]
.3 - .9M [1 - 3FT]: +44.5mm-0 [+1.75in-0]
.9 - 1.8M [3 - 6FT]: +55.6mm-0 [+2.19in-0]
1.8 - 3.7M [6 - 12FT]: +88.9mm-0 [+3.50in-0]
3.7 - 7.3M [12 - 24FT]: +165.1mm-0 [+6.50in-0]
7.3-14.6M [24 - 48FT]: +317.5mm-0 [+12.50in-0]
14.6 - 30.5M [48-100FT]: +622.3mm-0 [+24.50in-0]
OVER 30M [100FT] +2% OF FINISHED LENGTH

ITEM	DESCRIPTION	MATERIAL	FINISH
10	WRAP LABEL	VINYL	BLACK/YELLOW
9	OVERMOLD	TPE	YELLOW
8	COUPLING NUT	BRASS	NICKEL PLATED
7	CONTACT PIN	COPPER ALLOY	GOLD PLATED
6	MALE INSERT	PUR	BLACK
5	O-RING	VITON	RED
4	COUPLING NUT	BRASS	NICKEL PLATED
3	CONTACT SOCKET	COPPER ALLOY	GOLD PLATED
2	FEMALE INSERT	PUR	BLACK
1	CABLE, 22AWG, 300V, 105°	TPE JACKET	YELLOW

RELEASED EC NO.: ICG2019-0231 DRWN: RSTONE CHKD: M ZIELIN APPR: BWOODMAN2010/01/29	QUALITY SYMBOL ▽=0 ▽=0	GENERAL TOLERANCES (UNLESS SPECIFIED) <table border="1" style="width: 100%; border-collapse: collapse;"> <thead> <tr> <th></th> <th>mm</th> <th>INCH</th> </tr> </thead> <tbody> <tr> <td>4 PLACES</td> <td>±---</td> <td>±---</td> </tr> <tr> <td>3 PLACES</td> <td>±---</td> <td>±---</td> </tr> <tr> <td>2 PLACES</td> <td>±---</td> <td>±---</td> </tr> <tr> <td>1 PLACE</td> <td>±---</td> <td>±---</td> </tr> </tbody> </table>		mm	INCH	4 PLACES	±---	±---	3 PLACES	±---	±---	2 PLACES	±---	±---	1 PLACE	±---	±---	DIMENSION STYLE IN/MM	SCALE ---	DESIGN UNITS INCH	THIRD ANGLE PROJECTION
		mm	INCH																		
	4 PLACES	±---	±---																		
	3 PLACES	±---	±---																		
2 PLACES	±---	±---																			
1 PLACE	±---	±---																			
		DRAFT WHERE APPLICABLE MUST REMAIN WITHIN DIMENSIONS	DRAWN BY: LSTEMMLE DATE: 2010/01/25	TITLE MICRO-CHANGE CORDSET 3/4/5 P. FE STR/ MA STR 22/3-5 YELLOW TPE CABLE																	
			CHECKED BY: RE DATE: 2010/01/26	MOLEX INCORPORATED																	
			APPROVED BY: NSTAUDIG DATE: 2010/01/29	MATERIAL NO.: ---	DOCUMENT NO.: SD-120066-011	SHEET NO.: 1 OF 1															

THIS DRAWING CONTAINS INFORMATION THAT IS PROPRIETARY TO MOLEX INCORPORATED AND SHOULD NOT BE USED WITHOUT WRITTEN PERMISSION