



90 Degree Drop-In Hybrid Coupler From 1 GHz to 3 GHz Rated to 450 Watts

Hybrids Technical Data Sheet

PE2CP1053

Features

- 450 watts power
- 16 dB isolation
- 1000 MHz to 3000 MHz Frequency Range
- Gold plated leads
- 1.35:1 VSWR
- 1.35 inch by 0.5 inch package

Applications

- Test and measurement
- Military Communications
- Commercial Communications
- Wireless Communications
- SATCOM
- Military Electronic Systems

Description

The PE2CP1053 operates from 1000 MHz to 3000 MHz and can handle 450 watts of power with 16 dB isolation. The package is 1.35 inch by .5 inch and can be attached to a heat sink by screws. The gold plated leads are soldered to the PCB. This 90 degree hybrid has a VSWR of 1.35:1 and an insertion loss of 0.3 dB.

The PE2CP1053 is part of Pasternack's family of 90 degree hybrid couplers in drop-in packages. These couplers feature small drop-in packages that can handle power up to 1000 watts. They are available in both narrow and broad bandwidths. These quadrature hybrids are excellent for any situation to either equally split an input signal into two paths with a 90 degree phase shift between them or to combine two signals while maintaining high isolation between them.

Electrical Specifications

Description	Minimum	Typical	Maximum	Units
Frequency Range	1		3	GHz
Impedance		50		Ohms
Phase Difference		90		Degrees
Insertion Loss			0.25	dB
Isolation	16			dB
VSWR			1.35:1	
Amplitude Balance		±1.1		dB
Phase Balance		±5		Degrees
Input Power (CW)			450	Watts

Click the following link (or enter part number in "SEARCH" on website) to obtain additional part information including price, inventory and certifications: [90 Degree Drop-In Hybrid Coupler From 1 GHz to 3 GHz Rated to 450 Watts PE2CP1053](#)



90 Degree Drop-In Hybrid Coupler From
1 GHz to 3 GHz Rated to 450 Watts

Hybrids Technical Data Sheet

PE2CP1053

Mechanical Specifications

Size

Length	1.35 in [34.29 mm]
Width	0.28 in [7.11 mm]
Height	0.5 in [12.7 mm]

Configuration

Mechanical Specification Notes:

Finish per MIL-DTL-5541, Type 2, Rev. F, Class 3

Environmental Specifications

Temperature

Operating Range	-55 to +85 deg C
-----------------	------------------

Compliance Certifications (visit www.Pasternack.com for current document)

RoHS Compliant	
REACH Compliant	12/17/2015

Plotted and Other Data

Notes:

Typical Performance Data

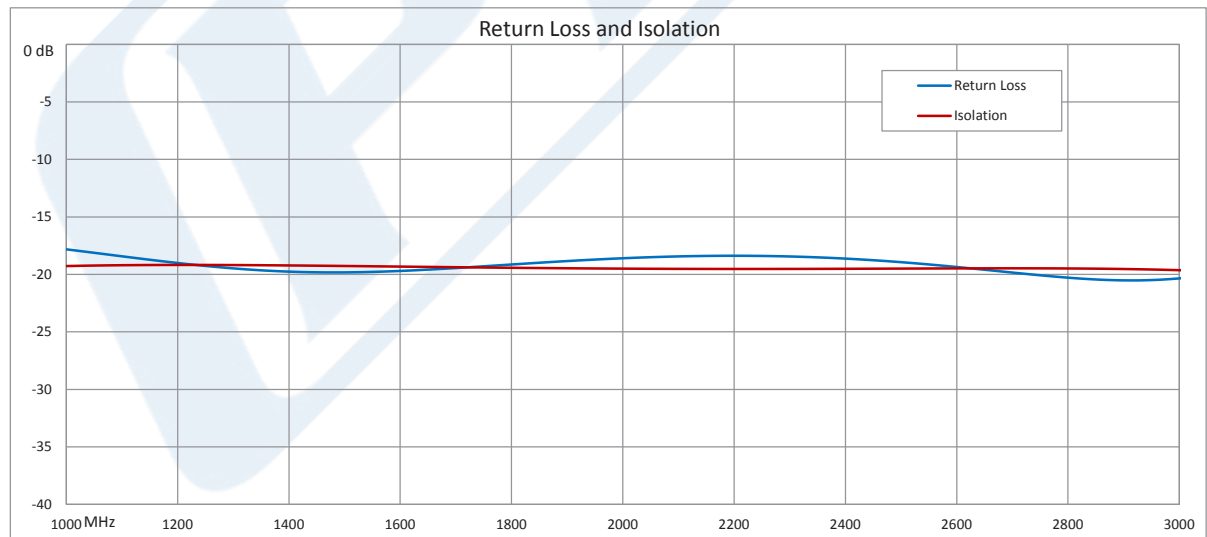

Click the following link (or enter part number in "SEARCH" on website) to obtain additional part information including price, inventory and certifications: [90 Degree Drop-In Hybrid Coupler From 1 GHz to 3 GHz Rated to 450 Watts PE2CP1053](#)



90 Degree Drop-In Hybrid Coupler From
1 GHz to 3 GHz Rated to 450 Watts

Hybrids Technical Data Sheet

PE2CP1053

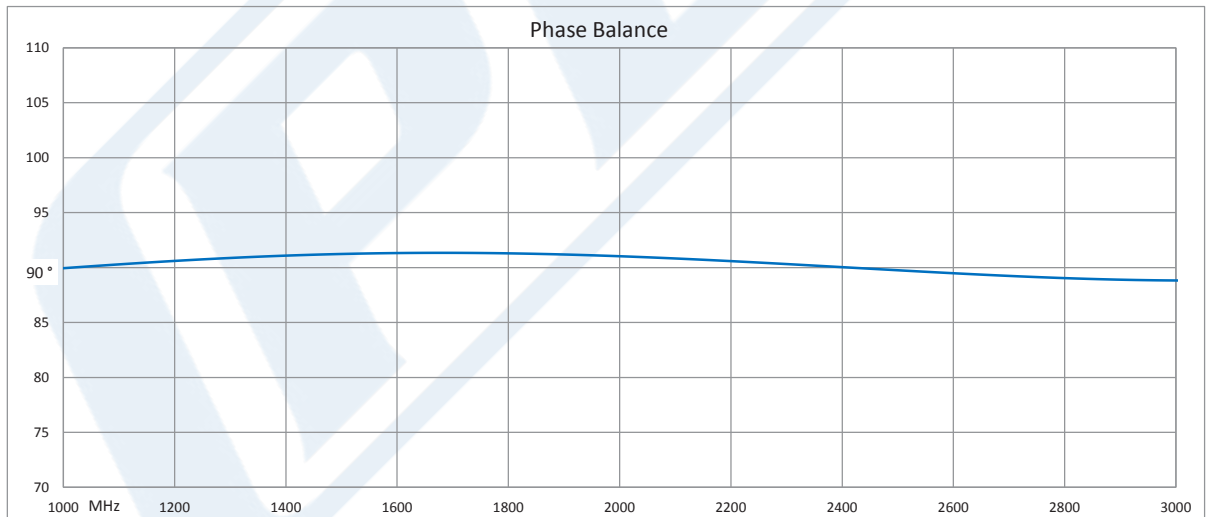
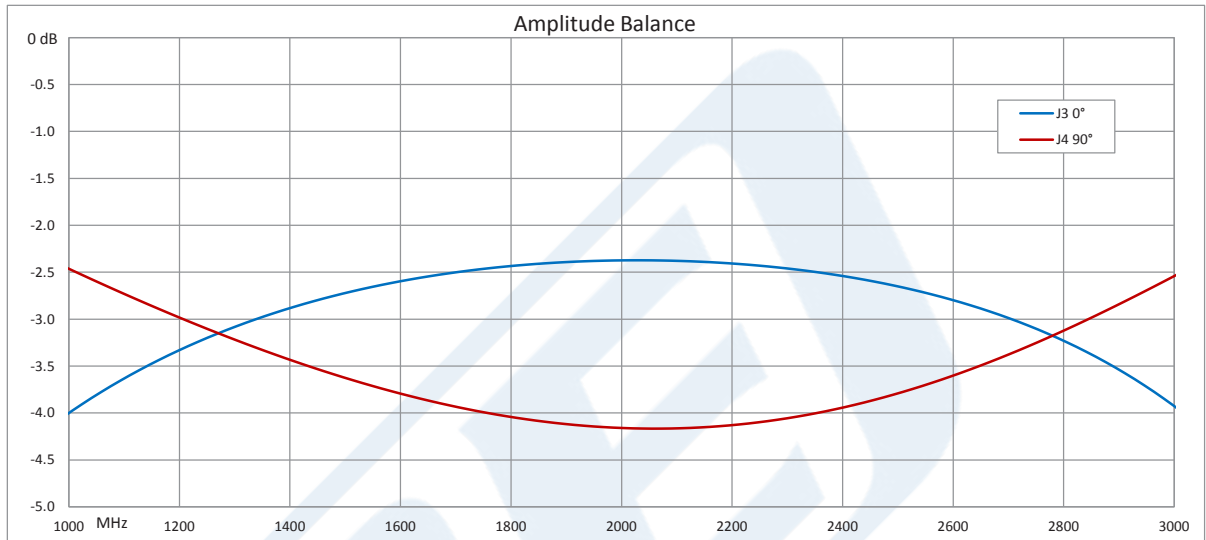

Click the following link (or enter part number in "SEARCH" on website) to obtain additional part information including price, inventory and certifications: [90 Degree Drop-In Hybrid Coupler From 1 GHz to 3 GHz Rated to 450 Watts PE2CP1053](#)



90 Degree Drop-In Hybrid Coupler From 1 GHz to 3 GHz Rated to 450 Watts

Hybrids Technical Data Sheet

PE2CP1053

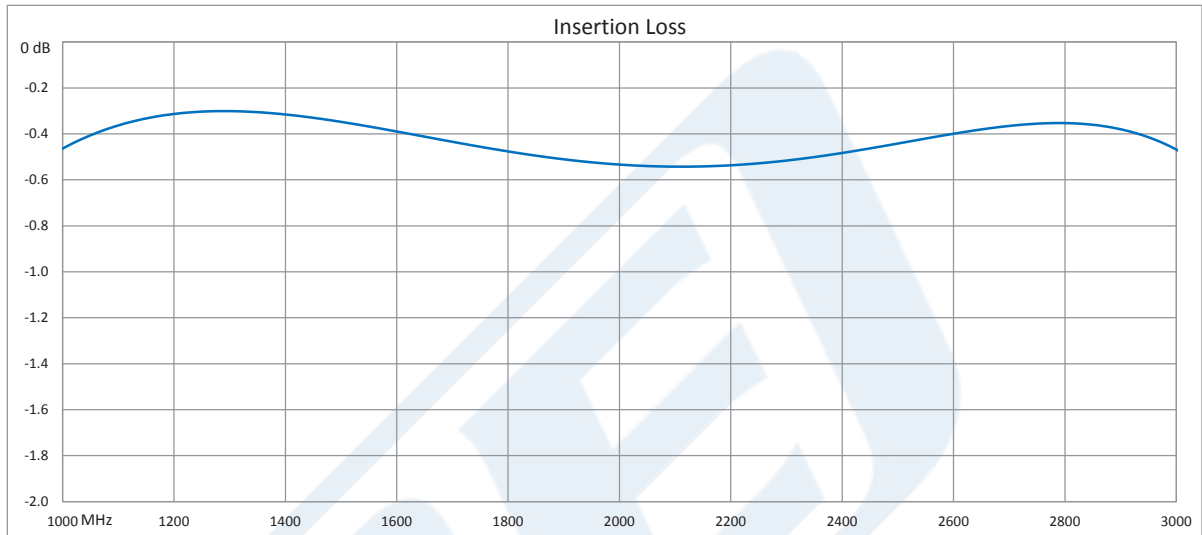

90 Degree Drop-In Hybrid Coupler From 1 GHz to 3 GHz Rated to 450 Watts from Pasternack Enterprises has same day shipment for domestic and International orders. Our RF, microwave and millimeter wave products maintain a 99% availability and are part of the broadest selection in the industry.

Click the following link (or enter part number in "SEARCH" on website) to obtain additional part information including price, inventory and certifications: [90 Degree Drop-In Hybrid Coupler From 1 GHz to 3 GHz Rated to 450 Watts PE2CP1053](http://www.pasternack.com/drop-in-coupler-1-3-ghz-450-watts-pe2cp1053-p.aspx)

URL: <http://www.pasternack.com/drop-in-coupler-1-3-ghz-450-watts-pe2cp1053-p.aspx>

The information contained in this document is accurate to the best of our knowledge and representative of the part described herein. It may be necessary to make modifications to the part and/or the documentation of the part, in order to implement improvements. Pasternack reserves the right to make such changes as required. Unless otherwise stated, all specifications are nominal. Pasternack does not make any representation or warranty regarding the suitability of the part described herein for any particular purpose, and Pasternack does not assume any liability arising out of the use of any part or documentation.

PE2CP1053 CAD Drawing

90 Degree Drop-In Hybrid Coupler From 1 GHz to 3 GHz Rated to 450 Watts

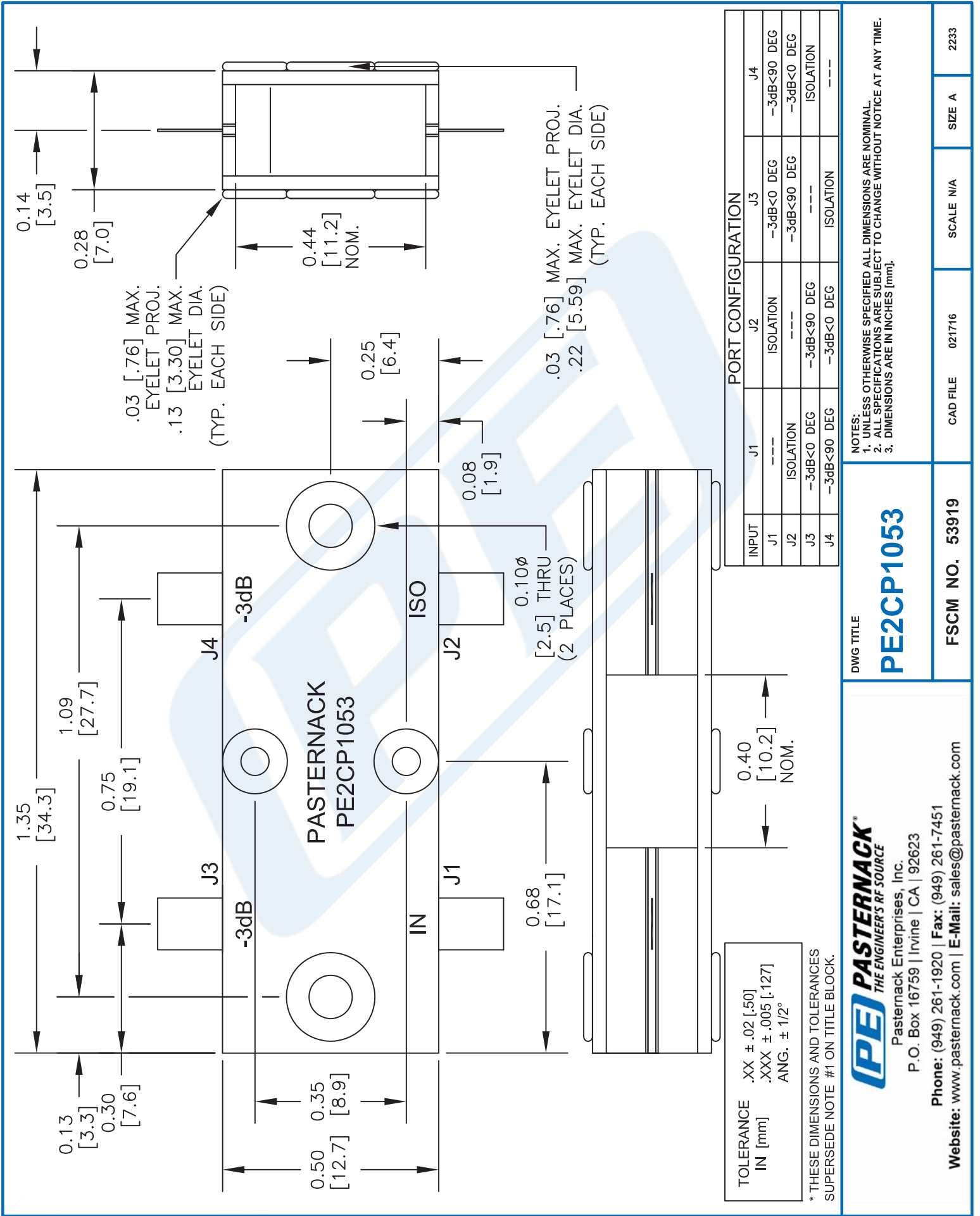

PE2CP1053 CAD Drawing

90 Degree Drop-In Hybrid Coupler From 1 GHz to 3 GHz Rated to 450 Watts

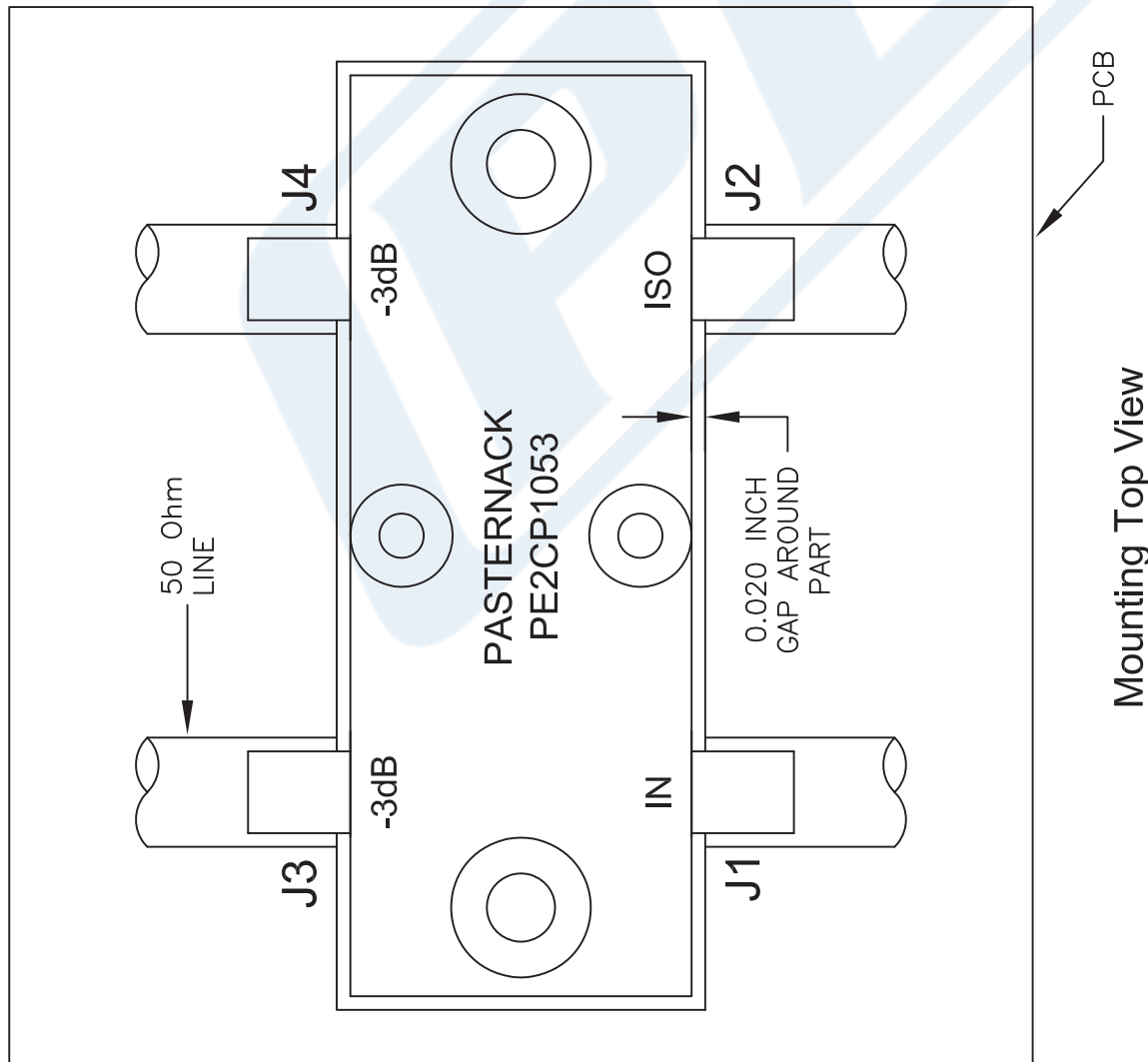
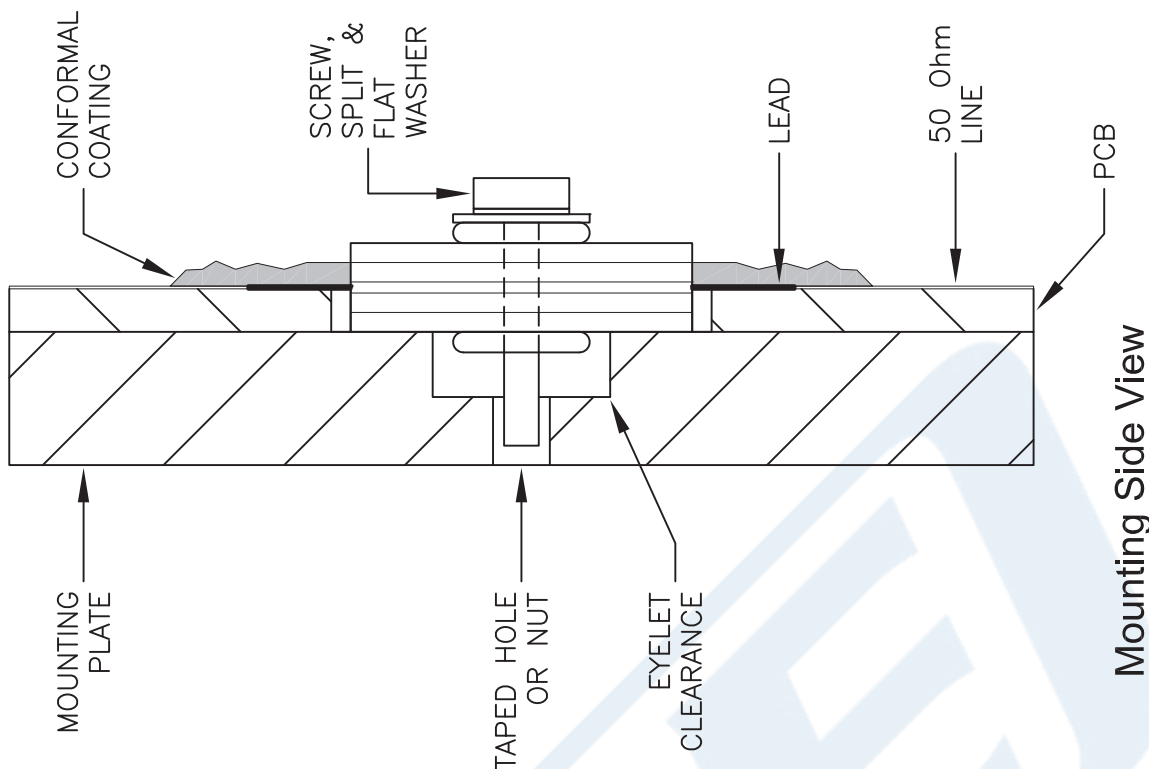

NOTE:

1. CONFORMAL COATING IS RECOMMENDED AT THE LEAD / 50 Ohm LINE INTERFACE FOR HIGH POWER APPLICATIONS TO PREVENT VOLTAGE ARCING.
2. TO INSURE PROPER GROUNDING THE BOTTOM PLATE OF COUPLER MUST LAY FLAT ON MOUNTING SURFACE. PLEASE ALLOW CLEARANCE FOR ALL EYELET PROJECTIONS IN BASE PLATE.
3. SOLDER LEADS TO 50 Ohm LINES USING LEAD FREE OR Sn63 ALLOY.
4. TORQUE STAINLESS STEEL SCREW, SPLIT AND FLAT WASHER TO 2.5 in-lbs.

DWG TITLE

PE2CP1053

- NOTES:
1. UNLESS OTHERWISE SPECIFIED ALL DIMENSIONS ARE NOMINAL.
 2. ALL SPECIFICATIONS ARE SUBJECT TO CHANGE WITHOUT NOTICE AT ANY TIME.
 3. DIMENSIONS ARE IN INCHES [mm].

PE PASTERNAK
 THE ENGINEER'S RF SOURCE
 Pasternack Enterprises, Inc.
 P.O. Box 16759 | Irvine | CA | 92623
 Phone: (949) 261-1920 | Fax: (949) 261-7451
 Website: www.pasternack.com | E-Mail: sales@pasternack.com

FSCM NO. 53919

CAD FILE 021716

SCALE N/A

SIZE A

2233