

REVISIONS		
C	REVISED PER ECNT	
D	REVISED PER DCR# T-22658	3/10/99 M.HIGGY

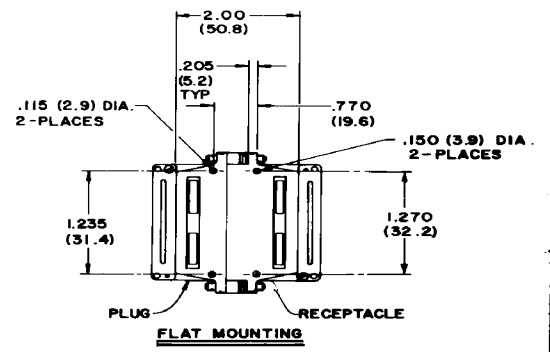
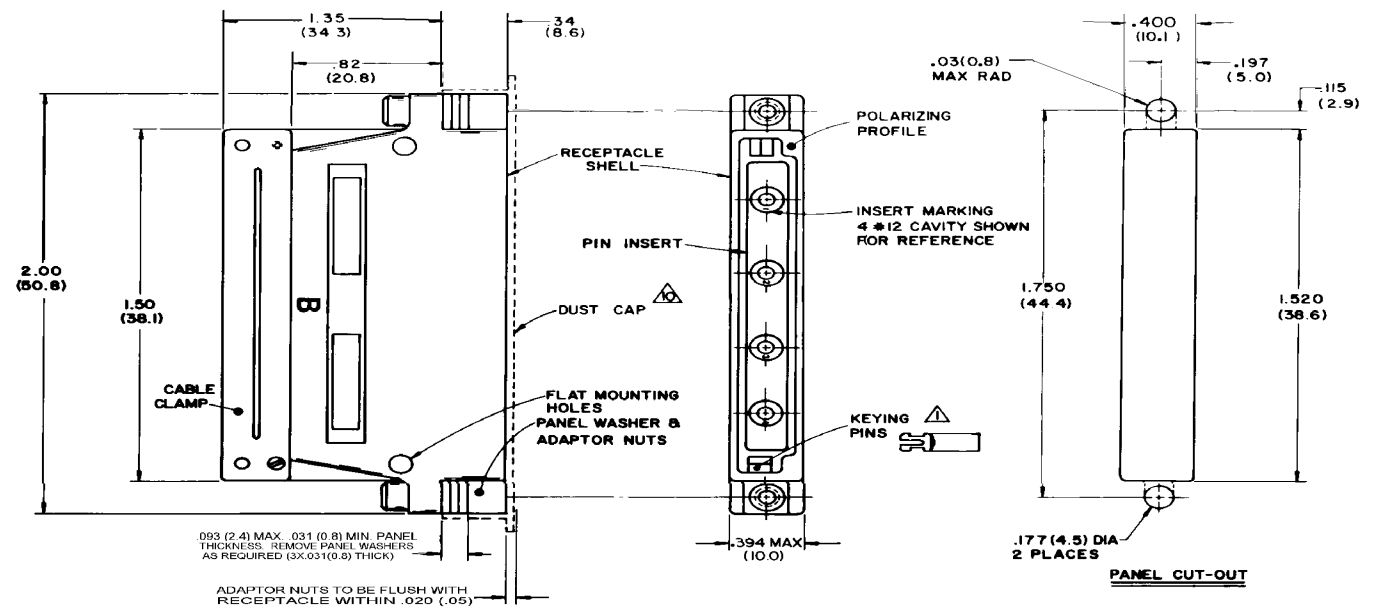

.093 (2.4) MAX. .031 (0.8) MIN. PANEL THICKNESS. REMOVE PANEL WASHERS AS REQUIRED (3X.031(0.8) THICK)

ADAPTOR NUTS TO BE FLUSH WITH RECEPTACLE WITHIN .020 (.05)

NOTES:

- 1 KEYING CODE DOES NOT FORM A PART OF RAYCHEM PART NUMBER SYSTEM AND SHOULD BE OMITTED WHEN ORDERING. KEYING PINS SUPPLIED UNINSTALLED. SEE TABLE II FOR KEYING POSITIONS.
- 2 COMPLETE CONNECTORS AND ACCESSORIES ARE INDIVIDUALLY BAGGED AND LABELED.
- 3 CONNECTOR IS ENVIRONMENTALLY SEALED MEETING THE REQUIREMENTS PER CONNECTOR SPECIFICATION D-6015.
- 4 REAR GROMMET INSERT WILL SEAL ON SMOOTH INSULATION FROM .097" TO .158" O.D.
- 5 CONNECTOR DESIGNED FOR USE WITH POWER AND SHIELDED CONTACTS PER TABLE I.
- 6 INSERTS ARE PERMANENTLY INSTALLED, CONTACTS MAY BE INSERTED AND REMOVED USING TOOL PER NOTE 8.
- 7 ALL UNUSED CAVITIES TO BE SEALED USING SEALING PLUG NUMBER M83723-28-12.
- 8 ALL CONTACTS SIZE 12 ARE INSERTED AND REMOVED USING TOOL NUMBER M83723-31-12.
- 9 REFER TO RAYCHEM SPECIFICATION D-6015 FOR COMPLETE DETAILS.
- 10 CONNECTOR SUPPLIED WITH A SHIPPING DUST CAP OVER ENGAGING END.
- 11 PART NUMBER VARIABLE: MTCR-10X-04P

1 = NICKEL PLATE PER MIL-C-26074  
3 = CADMIUM PLATE PER QQ-P-416 OVER NICKEL UNDERPLATE

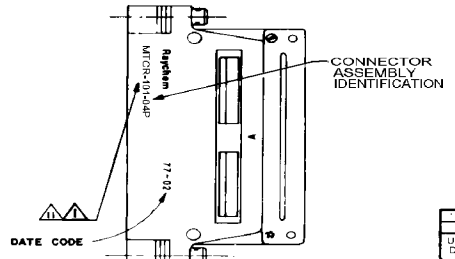

VIEW SHOWING IDENTIFICATION

If this document is printed it becomes uncontrolled.  
Check with the web for latest revision.









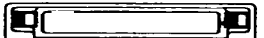
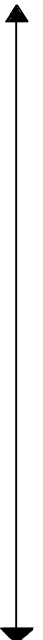

SPECIFICATION CONTROL DRAWING

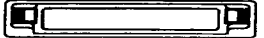
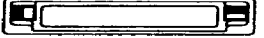
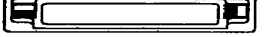
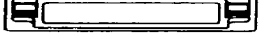
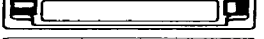
REV	DATE	BY	CHKD	DESCRIPTION
1				
UNLESS OTHERWISE SPECIFIED DIMENSIONS ARE IN INCHES AND TOLERANCES ARE:				
DEC .XXX .005	CRN	T-226-17		RAYCHEM
DEC .XX .02				TITLE
ANGLE				CONNECTOR, RCPT, RECTANGULAR, ENVIRONMENTAL, FIXED PIN INSERT ONE INCH MTC SERIES
CAD	T22658a.TIF			CORE DRAWING
		6448-7042		A 06090
				MTCR-10X-04P D

11

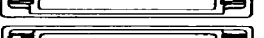
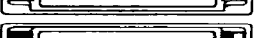
SHEET 1 OF 2

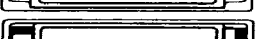
**TABLE II**  
KEYING CODE CHART 

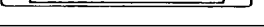
PART NUMBER 	* *	POSITION OF KEYS
MTCR-10X-04P-	AA	
	AB	
	AC	
	AD	
	BA	
	BB	
	BC	
	BD	
	CA	
	CB	
	CC	
	CD	
	DA	
	DB	
	DC	
	DD	
	MTCR-10X-04P-	

**TABLE I**

**PIN CONTACT AND TOOLING INFORMATION**

CONTACT TYPE	MILITARY PART NO.	WIRE STRIP LENGTH	TERMINATION TOOL
SHIELDED CONTACT FOR COAX CABLE D-602-0106 OR D-602-0094	_____	SEE DRAWING D-602-0106 OR D-602-0094	SEE DRAWING D-602-0106 OR D-602-0094
CONTACT FOR TWISTED PAIR D-602-0104	_____	SEE DRAWING D-602-0104	SEE DRAWING D-602-0104
POWER CONTACT SIZE 12	M39029/4-12-12	1/4" TO 5/16"	M22520/1-01 POSITIONER M22520/1-02

If this document is printed it becomes uncontrolled.  
Check with the web for latest revision.

<b>A</b>	CODE IDENT. NO. <b>06090</b>	DWG. NO. <b>MTCR-10X-04P</b>	<b>D</b>
DO NOT SCALE THIS DRAWING		CAD NAME: 122698B.TIF	SHEET 2 OF 2