

# ORCY-60U05x

## Isolated DC-DC Converter

The ORCY-60U05x is part of the isolated DC/DC converters that operate from a wide input range (18-75 VDC) and can cover both 24 Vin and 48 Vin input range.

These units will provide up to 75 W of output power. They are designed to be highly efficient and low cost.

Features include remote on/off, over current protection, over voltage shut down, over temperature protection and under-voltage lockout. These converters are provided in an industry standard 1/8 brick package.



### Key Features & Benefits

- 18 - 75 VDC Input
- 5 VDC @ 15 A Output
- Isolated
- High Efficiency
- High Power Density
- Fixed Frequency (320 kHz)
- Input Under-Voltage Lockout
- Input Over-Voltage Lockout
- Output Over-Voltage Shutdown
- Over Temperature Protection
- OCP/SCP
- Low Cost
- Output Voltage Trim
- Positive/Negative Remote Sense
- Basic Insulation
- Remote On/Off
- Class II, Category 2, Isolated DC/DC Converter (refer to IPC-9592B)
- UL60950-1 Recognized (UL/cUL)

### Applications

- Networking
- Computers and Peripherals
- Telecommunications



**bel** POWER  
SOLUTIONS &  
PROTECTION

a bel group

[belfuse.com/power-solutions](http://belfuse.com/power-solutions)

## 1. MODEL SELECTION

OUTPUT VOLTAGE	INPUT VOLTAGE	MAX. OUTPUT CURRENT	MAX. OUTPUT POWER	TYPICAL EFFICIENCY	MODEL NUMBER ACTIVE HIGH	MODEL NUMBER ACTIVE LOW
5.0 VDC	18 VDC - 75 VDC	15 A	75 W	92.5	ORCY-60U050	ORCY-60U05L

**NOTE:** Add "G" suffix at the end of the model number to indicate Tray Packaging.

## PART NUMBER EXPLANATION

0	R	CY	-	60	U	05	x	x
Mounting Type	RoHS Status	Series Name		Output Power	Input Range	Output Voltage	Active Logic	Package
0 - Through hole mount	RoHS	1/8 <sup>th</sup> Brick		75W	18 – 75 V	5.0 V	0 -Active high L- Active Low	G-Tray package

## 2. ABSOLUTE MAXIMUM RATINGS

PARAMETER	DESCRIPTION	MIN	TYP	MAX	UNIT
Continuous non-operating Input Voltage		-0.3	-	80	V
Input Transient Voltage	100 ms maximum	-	-	100	V
Remote On/Off		-0.3	-	18	V
I/O Isolation Voltage		-	-	1500	V
Ambient Temperature		-40	-	85	°C
Storage Temperature		-55	-	125	°C
Altitude		-	-	2000	m

**NOTE:** Ratings used beyond the maximum ratings may cause a reliability degradation of the converter or may permanently damage the device.

## 3. INPUT SPECIFICATIONS

All specifications are typical at 25°C unless otherwise stated.

PARAMETER	DESCRIPTION	MIN	TYP	MAX	UNIT
Operating Input Voltage		36	48	75	V
Input Current (full load)		-	-	2	A
Input Current (no load)		-	70	120	mA
Remote Off Input Current		-	1	3	mA
Input Reflected Ripple Current (rms)	With simulated source impedance of 10uH, 5Hz to 20MHz; use a 100uF/100V electrolytic capacitor with ESR=1 ohm max, at 200 kHz.	-	3	7	mA
Input Reflected Ripple Current (pk-pk)		-	20	50	mA
I <sup>2</sup> t Inrush Current Transient		-	-	0.02	A <sup>2</sup> s
Turn-on Voltage Threshold		-	32	35	V
Turn-off Voltage Threshold		30	31	-	V

**CAUTION:** This converter is not internally fused. An input line fuse must be used in application. Recommend a fast-acting fuse with maximum rating of 5A on system board. Refer to the fuse manufacture's datasheet for further information.

**NOTES:** 1. This converter has internal L-C (1.0uH-1.0uF) filter.  
2. All specifications are typical at 25 °C unless otherwise stated.

## 4. OUTPUT SPECIFICATIONS

All specifications are typical at nominal input, full load at 25°C unless otherwise stated.

PARAMETER	DESCRIPTION	MIN	TYP	MAX	UNIT
Output Voltage Set Point	Vin=48 V, Io=50%Load	3.25	3.3	3.35	V
Load Regulation		-	±4	±9	mV
Line Regulation		-	±3	±8	mV
Regulation Over Temperature		-	±9	±16	mV
Ripple and Noise (pk-pk)	0-20 MHz BW, with a 1µF ceramic capacitor and the minimum external cap at output	-	55	90	mV
Ripple and Noise (rms)		-	12	25	mV
Output Ripple and Noise(Pk-Pk) under worst case	over all operating input voltage, load and ambient temperature	-	-	100	mV
Output Current Range		0	-	15	A
Output DC Current Limit		19	22	26	A
Short Circuit Surge Transient		-	-	1	A <sup>2</sup> s
Rise time		-	-	15	ms
Turn on Delay Time	Enable form Vin	-	35	70	ms
	Enable form ON/OFF	-	35	70	ms
Overshoot at Turn on		-	0	5	%
Output Capacitance	100 µF ceramic capacitor and 1400 µF low ESR polymer capacitor	-	1500	-	µF
<b>Transient Response</b>					
ΔV 50%~75% of Max Load		-	150	250	mV
Settling Time	di/dt=0.1A/µs, Vin=48 VDC, Ta=25°C, with a 1 µF ceramic capacitor and the minimum external cap at output	-	120	200	µs
ΔV 75%~50% of Max Load		-	150	250	mV
Settling Time		-	120	200	µs

## 5. GENERAL SPECIFICATIONS

PARAMETER	DESCRIPTION	MIN	TYP	MAX	UNIT
Efficiency	Vin=48 V, full load.	86	89	-	%
Switching Frequency		-	600	-	kHz
FIT	Calculated Per Bell Core SR-332 (Vin=48V, Vo=3.3V, Io=80%load, Ta = 25 °C, FIT=10 <sup>9</sup> /MTBF)	-	TBD	-	-
Over Temperature Protection		-	120	140	°C
Over Voltage Protection (Static)		-	4.29	5.28	V
Weight		-	13	-	g
Dimensions (L x W x H)	For 0RSB-50T03D		1.30 x 0.90 x 0.38		Inches
			33.02 x 22.86 x 9.60		Millimeters
	For SRSB-50T03D		1.30x0.90x0.36		Inches
			33.02x22.86x9.24		Millimeters
<b>Isolation Characteristics</b>					
Input to Output		-	-	1500	V
Isolation Resistance		10M	-	-	Ohm
Isolation Capacitance		-	3900	-	pF

### 6. EFFICIENCY DATA

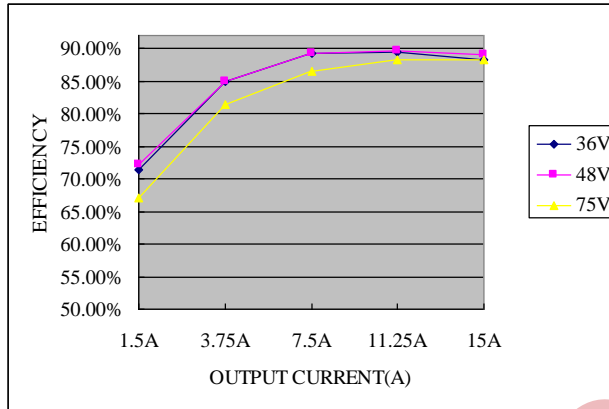

### 7. THERMAL DERATING CURVE

Maximum junction temperature of semiconductors derated to 120 °C.

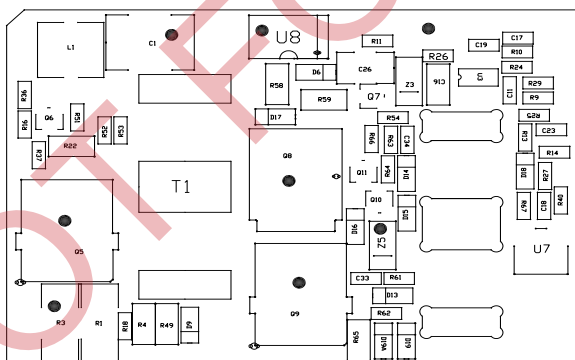
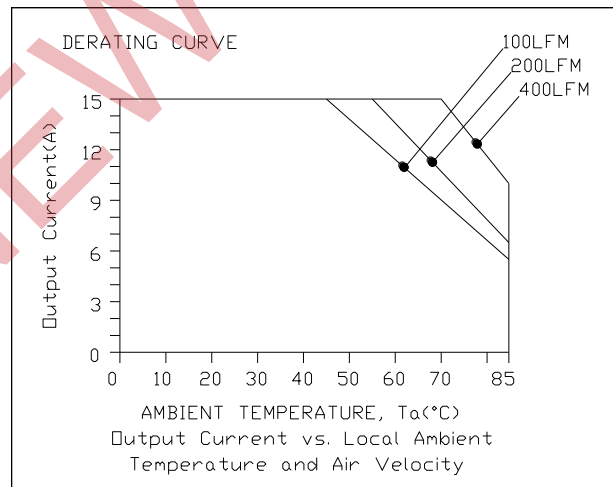
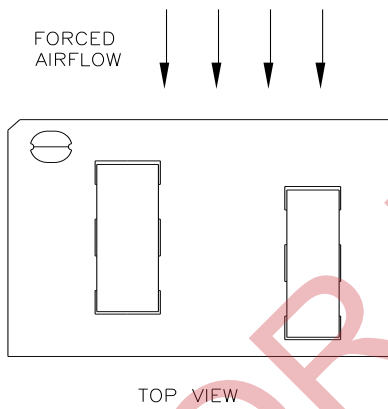

Temperature reference points on top side

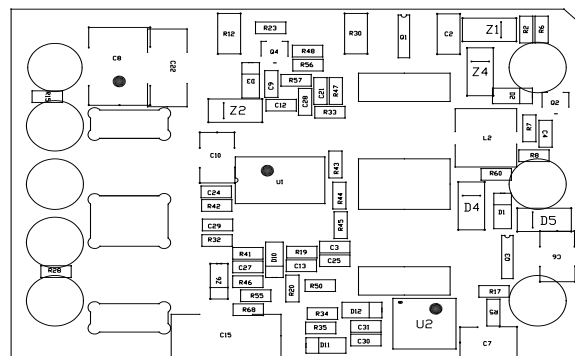

Temperature reference points on bottom side

**8. REMOTE ON/OFF**

PARAMETER	DESCRIPTION	MIN	TYP	MAX	UNIT
Signal Low (Unit On)	Active Low	-0.3	-	0.8	V
Signal High (Unit Off)	Remote On/Off pin is open, the module is off.	2.95	-	18	V
Current Sink		0	-	1	mA

Recommended remote on/off circuit for active low

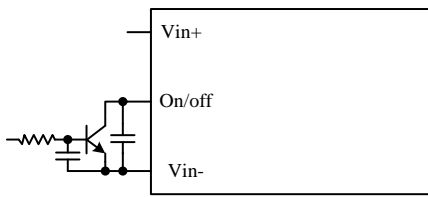

*Control with open collector/drain circuit*

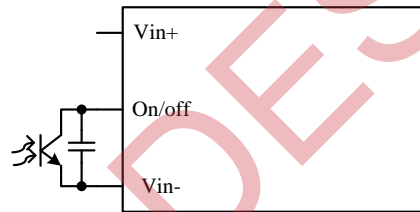

*Control with photocoupler circuit*

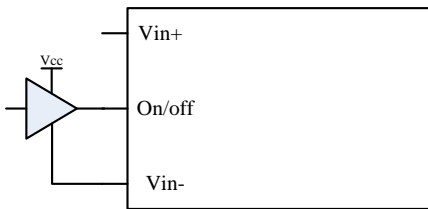

*Control with logic circuit*

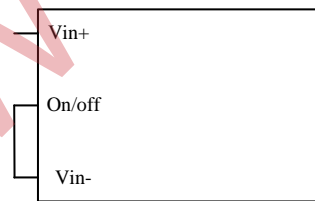

*Permanently on*

### 9. OUTPUT TRIM EQUATIONS

Equations for calculating the trim resistor are shown below. The Trim Down resistor should be connected between the Trim pin and GND pin. The Trim Up resistor should be connected between the Trim pin and the Vout pin. Only one of the resistors should be used for any given application.

Minimum trim down voltage is 2.97 V

Maximum trim up voltage is 3.63 V.

The total voltage increased by trim and remote sense should not exceed 10% of the nominal output voltage.

$$R_{trimdown} = \frac{511}{|\delta|} - 10.22 [k\Omega]$$

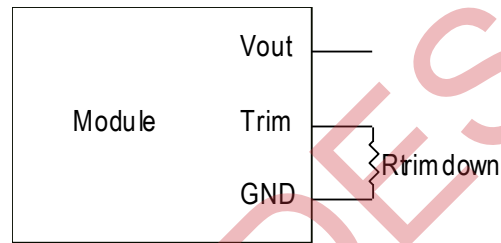

$$R_{trimup} = \frac{(100 + \delta) \cdot V_o \cdot 5.11 - 626}{1.225 \cdot \delta} - 10.22 [k\Omega]$$

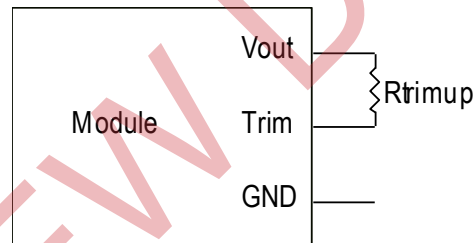

**NOTE:**

$$\delta = \frac{(V_o_{req} - V_o)}{V_o} \times 100 [\%]$$

$V_o_{req}$  = Desired (trimmed) output voltage [V]

Output voltage  $V_o$  = 3.308 V

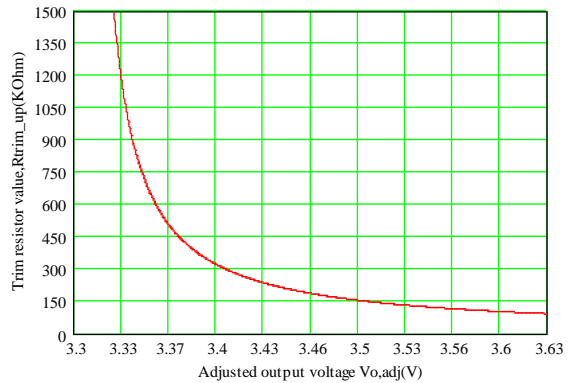
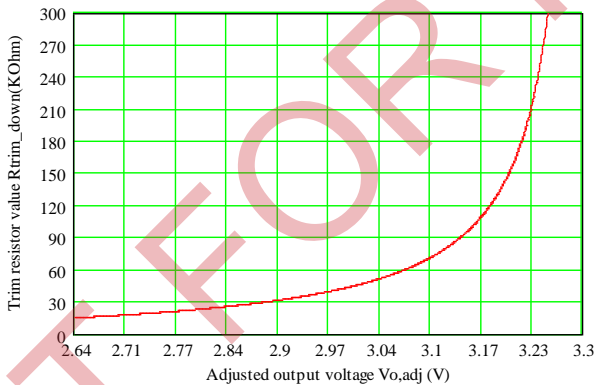

**10. REMOTE SENSE**

This module has remote sense compensation feature. It can minimize the effects of resistance between module's output and load in system layout and facilitates accurate voltage regulation at load terminals or other selected point.

1. The remote sense lines carries very little current and hence do not require a large cross-sectional area.
2. This module compensates for a maximum drop of 10% of the nominal output voltage.
3. If the unit is already trimmed up, the available remote sense compensation range should be correspondingly reduced. The total voltage increased by trim and remote sense should not exceed 10% of the nominal output voltage.
4. When using remote sense compensation, all the resistance, parasitic inductance and capacitance of the system are incorporated within the feedback loop of this module. It can make an effect on the module's compensation, affecting the stability and dynamic response. A 0.1uF ceramic capacitor can be connected at the point of load to de-couple noise on the sense wires.
5. Recommend the connection of remote sense compensation as below figure. There are a resistor RS+ (100 ohm) from Vo+ to Sense+ and a resistor RS- (51 ohm) from Vo- to Sense- inside of this module.

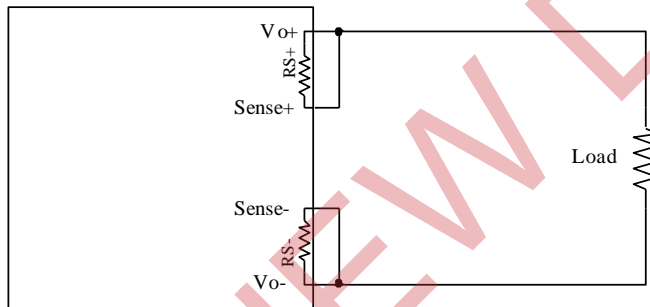

6. If not using remote sense compensation, please connect sense directly to output at module's pin, that is, connect sense+ to Vo+ and sense- to Vo- at module's pin, the shorter the better. See below figure.

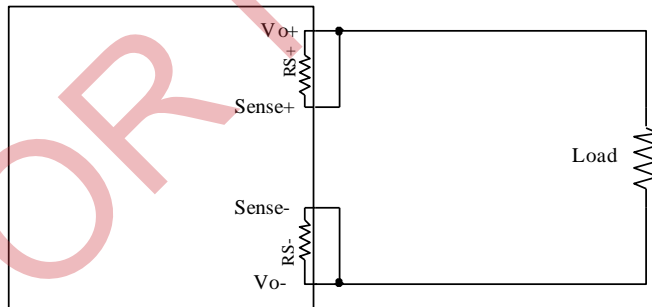

11. RIPPLE AND NOISE WAVEFORM

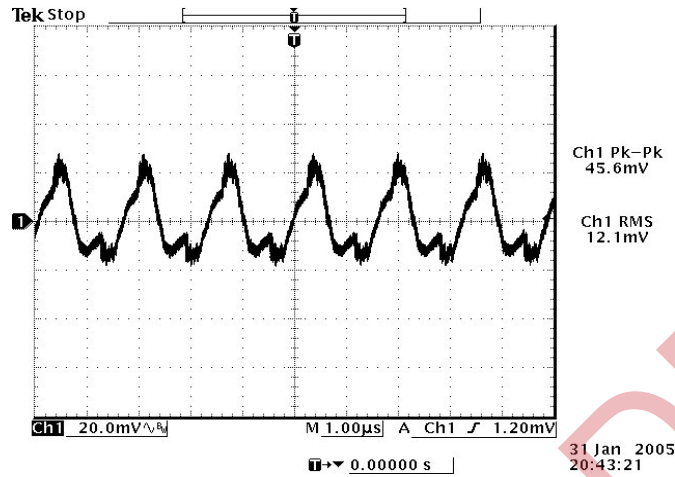

48 Vdc input, 3.3 Vdc/15 A output

Ripple and noise at full load, and with a 1µF ceramic cap and a 3000 µF cap at output, Ta=25 deg C.

12. TRANSIENT RESPONSE WAVEFORMS

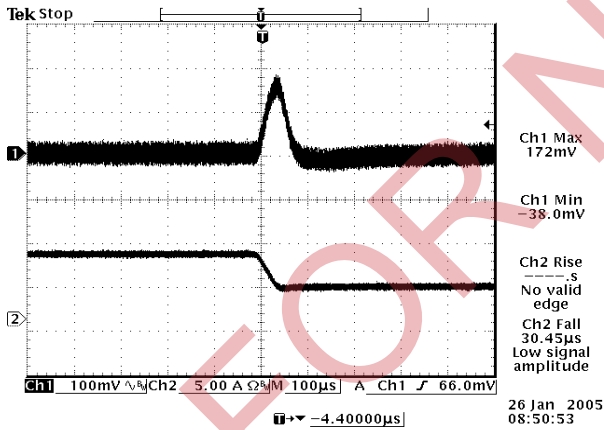

50%-75% Load Transients at Vin=48 V

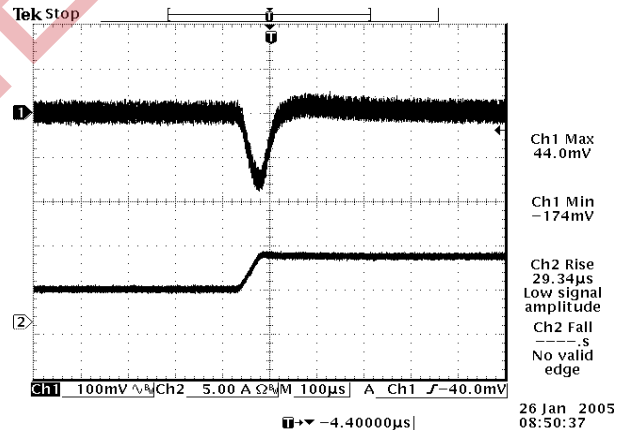

75%-50% Load Transients at Vin=48 V

NOTE: Transient response at di/dt=0.1A/µs, with 1µF ceramic cap and 3000µF cap at output, and Ta=25 deg C.



### 13. OVER CURRENT PROTECTION

To provide protection in a fault output overload condition, the module is equipped with internal current-limiting circuitry and can endure current limiting for a few milli-seconds. If the overcurrent condition persists beyond a few milliseconds, the module will shut down into hiccup mode and restart once every 300 ms. The module operates normally when the output current goes into specified range. The typical average output current is 0.8 A during hiccup.

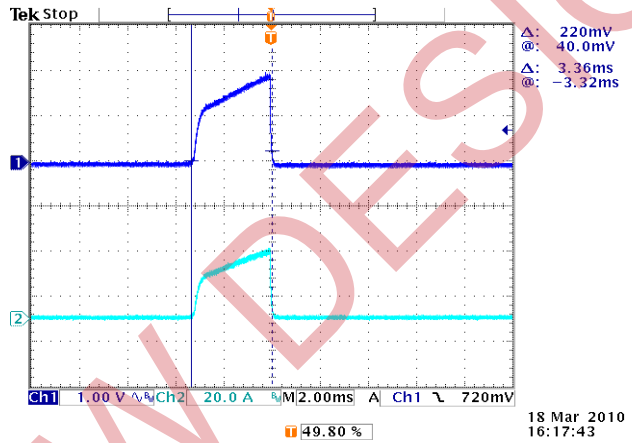
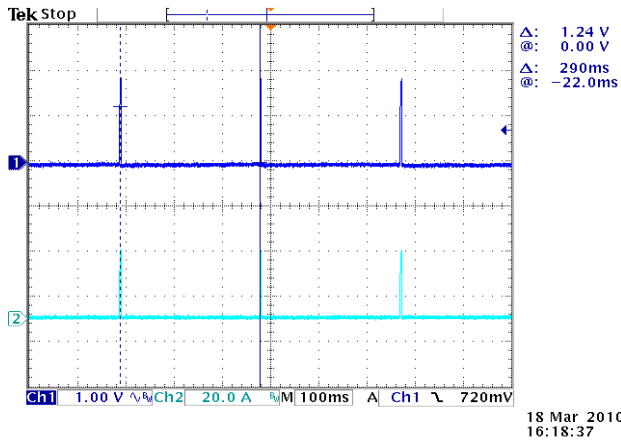

Expansion of on time portion of above figure

### 14. OVER VOLTAGE PROTECTION

The output overvoltage protection consists of circuitry that monitors the voltage on the output terminals. If the voltage on the output terminals exceeds the over voltage protection threshold, the module will shutdown into hiccup mode and restart once every 400ms. The module operates normally when the fault is cleared.

Test setup:

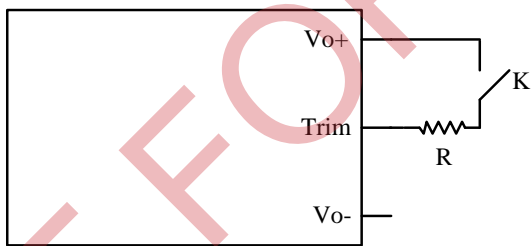

R=100 ohm

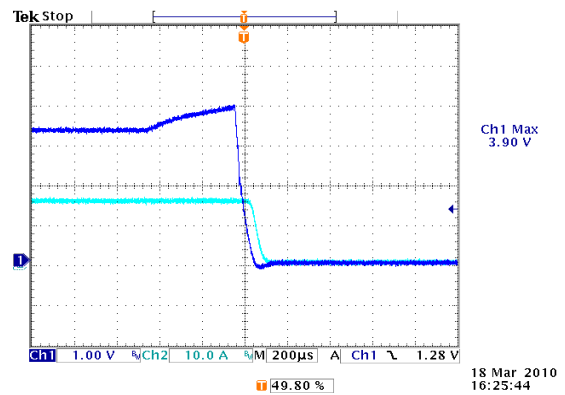

CH1: Output voltage waveform  
CH2: Output Current waveform

### 15. OVER TEMPERATURE PROTECTION

The OTP is achieved by thermistor U1 and the threshold is set at 120C in non-latch mode; the hottest component Q5 reaches 130C with 100LFM air flow correspondingly. It will restart automatically when the temperature falls down to 100C. The protecting point will be varied a little under different conditions (air flow, ambient temperature, input voltage, load...).

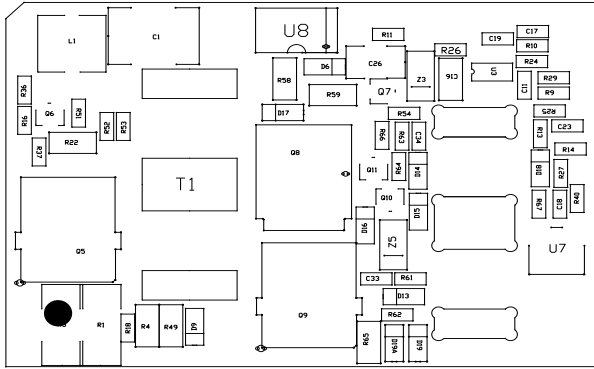

the hottest component Q5 on top view



thermistor U1 on bottom view

### 16. UNDER VOLTAGE LOCKOUT

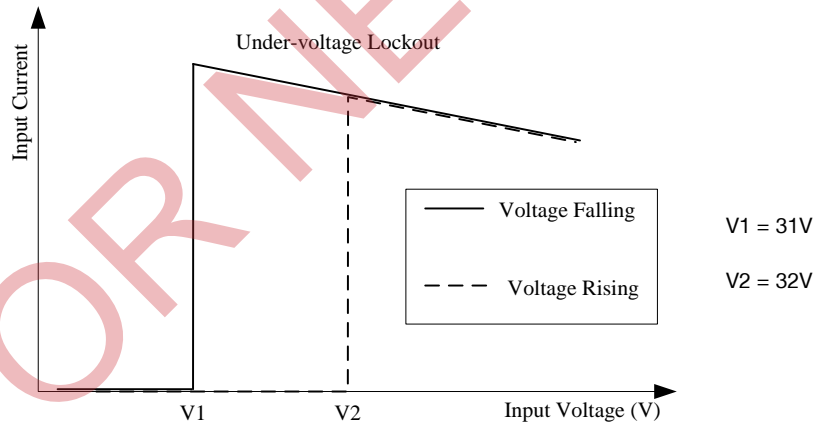

### 17. STARTUP & SHUTDOWN

#### RISE TIME

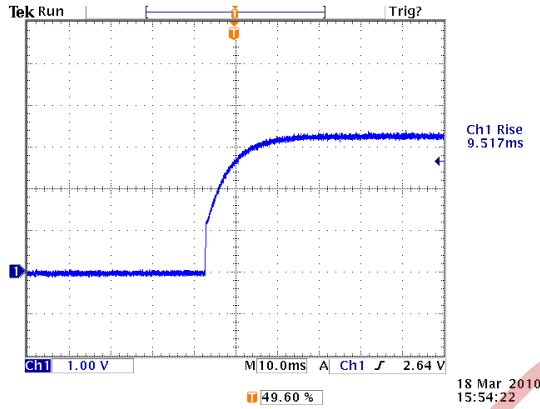

Test Condition: 48Vin, 3.3V/15A

#### STARTUP TIME

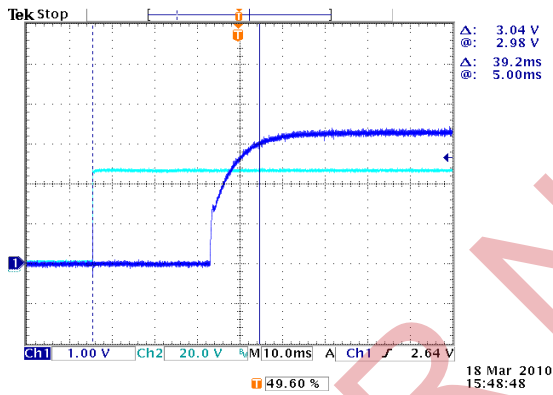

Startup from Vin  
Ch1: Vo, Ch2: Vin  
Test Condition: 48Vin, 3.3V/15A

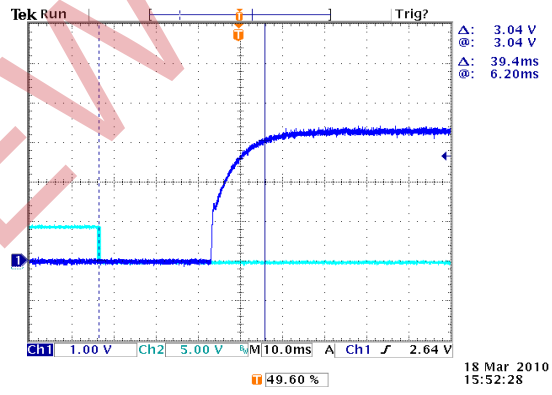

Startup from on/off  
Startup from on/off, Ch2: Vin  
Test Condition: 48Vin, 3.3V/15A

#### SHUTDOWN

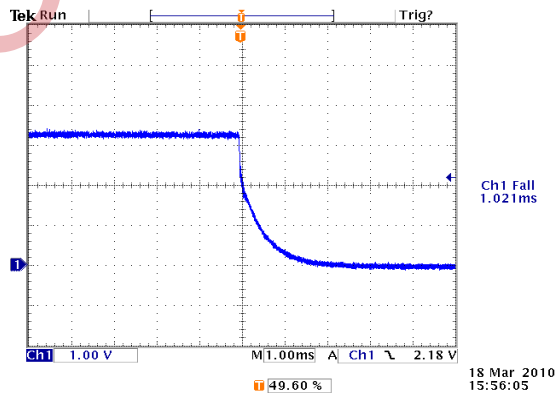

Test Condition 48Vin, 3.3V/15A



Asia-Pacific  
+86 755 298 85888

Europe, Middle East  
+353 61 225 977

North America  
+1 408 785 5200

18. MECHANICAL DIMENSIONS

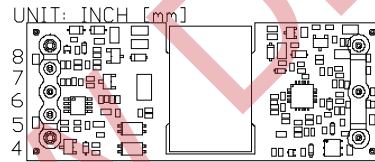
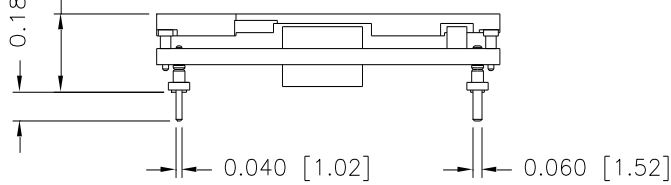
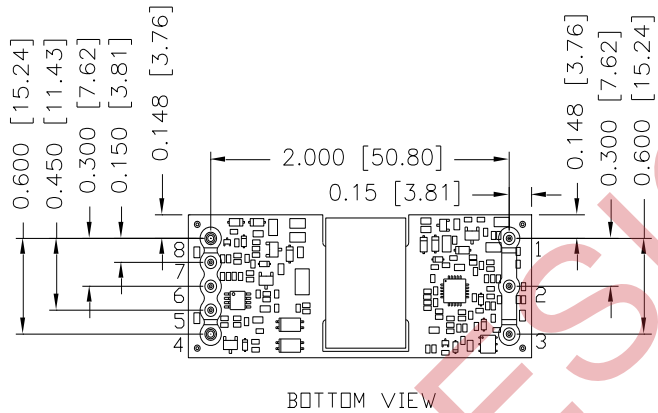
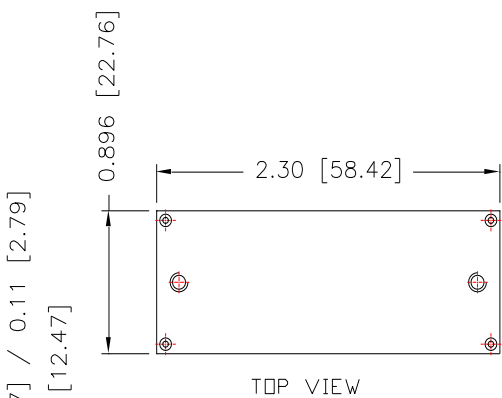

Pin Connections

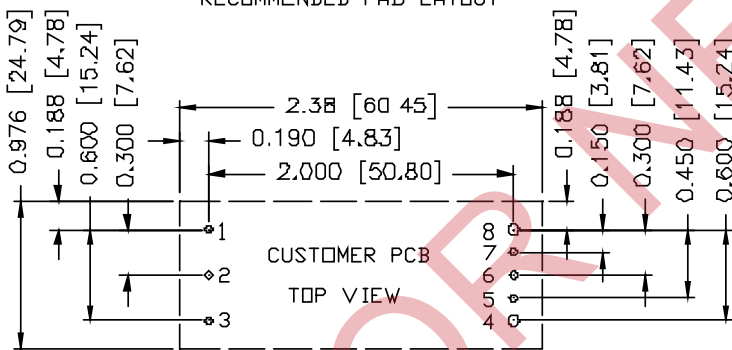

1,2,3,5,6,7  $\varnothing$ 0.047 HOLE SIZE,  $\varnothing$ 0.08 min PAD SIZE  
 4,8  $\varnothing$ 0.07 HOLE SIZE,  $\varnothing$ 0.10 min PAD SIZE

Pin	Name	Function	Pin Dia
1	Vin+	Positive input voltage	0.040"
2	On/Off	Input to turn converter on and off, referenced to Vin-	0.040"
3	Vin-	Negative input voltage	0.040"
4	Vout-	Negative output voltage	0.060"
5	Sense-	Negative remote sense	0.040"
6	Trim	Output voltage trim	0.040"
7	Sense+	Positive output voltage	0.040"
8	Vout+	Positive output voltage	0.060"

- Notes:** 1. Pin 5 must be connected to Vout-.<sup>1</sup>  
 2. Leave Pin 6 open for nominal voltage.<sup>1</sup>  
 3. Pin 7 must be connected to Vout+.<sup>1</sup>

**NOTE:** This module is recommended and compatible with Pb-Free Wave Soldering and must be soldered using a peak solder temperature of no more than 260°C.

**NOTE:**

- 1) All Pins: Material - Copper Alloy;  
 Finish - 3 micro inches minimum Gold over 50 micro inches minimum Nickel plate.
- 2) Undimensioned components are shown for visual reference only.
- 3) All dimensions in inches; Tolerances: x.xx +/-0.02 in[0.5mm].  
 x.xxx +/-0.010 in[0.25mm]. Unless otherwise stated.



**REVISION HISTORY**

DATE	REVISION	CHANGES DETAIL	APPROVAL
2008-01-22	PA	First release	XQ Han
2008-04-02	PB	Add thermal derating curve, dynamic plot, mechanical outline and ripple waveform	XQ Han
2009-02-20	PC	Update no-load input current, load regulation, line regulation, output ripple and noise, output DC current limit, turn on time, transient response, switching frequency, derating, efficiency typical value and efficiency data..	XQ Han
2010-09-21	D	Add P/N ORCY-60U05A with 0.11" pin length.	XF jiang
2010-12-30	E	Add P/N ORCY-60U05A with 0.11" pin length.	Falling Tao
2011-03-02	F	1. Add input transient voltage in absolute maximum ratings. 2. Update TD.	XF jiang
2011-11-03	G	Add TD with Vin=18V, Vin=24V, Vin=48V and Vin=75V.	XF jiang
2012-04-28	H	Add pre-bias start up of output specification	XF jiang
2013-08-04	I	Add 'T': conformal coated version.	XF jiang

**For more information on these products consult: [tech.support@psbel.com](mailto:tech.support@psbel.com)**

**NUCLEAR AND MEDICAL APPLICATIONS** - Products are not designed or intended for use as critical components in life support systems, equipment used in hazardous environments, or nuclear control systems.

**TECHNICAL REVISIONS** - The appearance of products, including safety agency certifications pictured on labels, may change depending on the date manufactured. Specifications are subject to change without notice.



Asia-Pacific  
+86 755 298 85888

Europe, Middle East  
+353 61 225 977

North America  
+1 408 785 5200