

# K50 Pro Compact with Audible Indicator

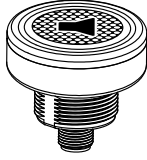

## Datasheet

50 mm Compact Programmable Multicolor RGB Audible Indicator



- Bright, uniform indicator light
- Designed with integrated audible alarm
- Available for lower profile applications
- Seven default colors in one device (Green, Red, Yellow, Blue, White, Cyan, Magenta)
- Programmable using Banner's Pro Editor software and Pro Converter Cable
- 30 mm threaded polycarbonate base
- Translucent polycarbonate cover
- Rugged IP67, IP69K per DIN 40050-9 and UL Type 4X and UL Type 13 design
- Bimodal inputs (PNP/NPN), depending on source wiring
- Variety of connector options
- 14 different tones available including intensity and input control
- Two model options - with or without RGB indication

## Pro Editor

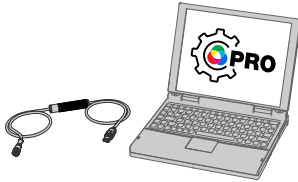

Use Banner's Pro Editor software and Pro Converter Cable to create custom configurations by selecting different colors, flash patterns, and animations. For more information visit [www.bannerengineering.com/proeditor](http://www.bannerengineering.com/proeditor).

## Models

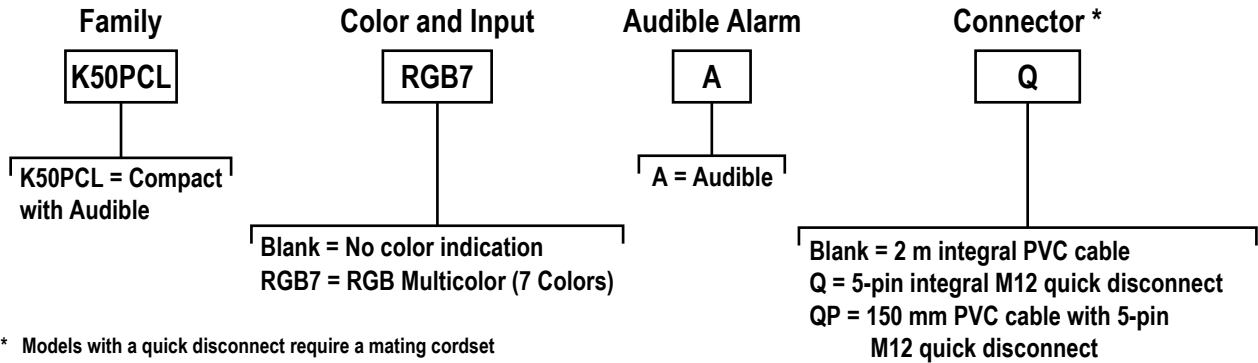

## Wiring Diagrams

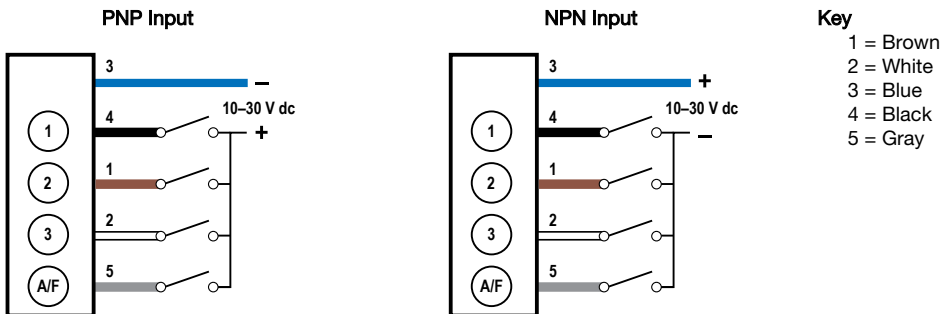

Table 1: RGB with Audible Indicator Default Values

Color	Red	Green	Yellow	Blue	Magenta	Cyan	White	Audible (No color)
Input 1	X		X		X		X	
Input 2		X	X			X	X	
Input 3				X	X	X	X	
Input 4 <sup>1</sup>								X

Table 2: Audible Indicator Only – Default Values for Low Intensity Tones

Audible	Continuous 2	Whoop	Pulse	Staccato	Siren	Jingle	Melody 1
Input 1	X			X	X		X
Input 2		X		X		X	X
Input 3			X		X	X	X
Input 4 <sup>2</sup>							

An "X" denotes an active input, for example when Input 1 and Input 3 are active, the indicator will show Magenta.

## Specifications

### Supply Voltage and Current

12 V DC to 30 V DC

**Standard Models:** 210 mA maximum

- 199 mA at 12 V DC
- 83 mA at 24 V DC
- 69 mA at 30 V DC

**Audible-Only Models:** 25 mA maximum

- 22 mA at 12 V DC
- 14 mA at 24 V DC
- 13 mA at 30 V DC

### Supply Protection Circuitry

Protected against reverse polarity and transient voltages

### Leakage Current Immunity

400 µA

### Input Response Time

250 milliseconds maximum

### Audible Characteristics

Values shown apply to continuous tone. Frequency and intensity response vary depending on the Audible Tone selected.

2.9 KHz ± 250 Hz

Audible Intensity:

- Low intensity at 2.9 KHz: 83 dB at 1 m
- Medium intensity at 2.9 KHz: 88 dB at 1 m
- High intensity at 2.9 KHz: 92 dB at 1 m

### Connections

Integral 5-pin M12 male quick-disconnect connector, 150 mm (6 in) PVC cable with an M12 quick disconnect, or 2 m (6.5 ft) integral PVC cable, depending on model. Models with a quick disconnect require a mating cordset.

### Mounting

M30 by 1.5 threaded base, maximum torque 4.5 N-m (40 inch-lbf)  
Mounting nut included

### Construction

Model Base, Dome, and Nut: Polycarbonate

### Vibration and Mechanical Shock

Meets IEC 60068-2-6 requirements (Vibration: 10 Hz to 55 Hz, 1.0 mm amplitude, 5 minutes sweep, 30 minutes dwell)  
Meets IEC 60068-2-27 requirements (Shock: 30G 11 ms duration, half sine wave)

### Operating Conditions

-40 °C to +50 °C (-40 °F to +122 °F)

90% at +50 °C maximum relative humidity (non-condensing)

Storage Temperature: -40 °C to +70 °C (-40 °F to +158 °F)

### Environmental Rating

IP67, IP69K per DIN 40050-9

Meets UL Type 4X, and UL Type 12 or UL Type 13 when mounted in a UL Type 12 or Type 13 enclosure

All cabled models also meet IP69K per DIN 40050-9 if the cable and cable entrance are protected from high-pressure spray

### Certifications



**Banner Engineering Europe** Park Lane, Culliganlaan 2F  
bus 3, 1831 Diegem, BELGIUM



**Turck Banner LTD** Blenheim House, Blenheim Court,  
Wickford, Essex SS11 8YT, Great Britain



### Pro Editor Configuration

Connection to Pro Editor software enables control of:

- Animation: On, Flash, Two Color Flash, 50/50, 50/50 Rotate, Chase, Intensity Sweep, Demo
- Color: Green, Red, Yellow, Blue, White, Cyan, Magenta, Amber, Rose, Lime Green, Orange, Sky Blue, Violet, Spring Green
- Intensity: Low, Medium, High
- Speed: Slow, Standard, Fast
- Audible Tones: Pulse, Wobble, Strobe, Whoop, Staccato, Siren, Continuous 1, Continuous 2, Jingle, Melody 1, Melody 2, Melody 3
- Audible Intensity: Low, Medium, High

Pro Converter Cable required to interface between PC and indicator, see accessories

### Default Indicator Characteristics

Color	Dominant Wavelength (nm) or Color Temperature (CCT)	Color Coordinates <sup>3</sup>		Lumen Output (Typical at 25 °C)
		x	y	
Green	532	0.181	0.735	8.9
Red	621	0.691	0.308	3.9
Yellow	578	0.473	0.474	11.6
Blue	467	0.137	0.056	1.6
Magenta	-	0.379	0.177	5.7
Cyan	492	0.150	0.334	10.1
Amber	590	0.552	0.414	7.8
Rose	-	0.508	0.230	4.7
Lime Green	565	0.393	0.535	11.5
Orange	600	0.611	0.370	6
Sky Blue	485	0.146	0.241	10.6
Violet	-	0.212	0.091	3.4
Spring Green	509	0.157	0.553	9.3
White	5700K	0.328	0.337	13.7

### Required Overcurrent Protection



**WARNING:** Electrical connections must be made by qualified personnel in accordance with local and national electrical codes and regulations.

Overcurrent protection is required to be provided by end product application per the supplied table.

Overcurrent protection may be provided with external fusing or via Current Limiting, Class 2 Power Supply.

Supply wiring leads < 24 AWG shall not be spliced.

For additional product support, go to [www.bannerengineering.com](http://www.bannerengineering.com).

Supply Wiring (AWG)	Required Overcurrent Protection (Amps)
20	5.0
22	3.0
24	2.0
26	1.0
28	0.8
30	0.5

<sup>1</sup> Input 4 controls audible functionality. Apply 12 V DC to 30 V DC to add audible to the color indication, or leave floating for color indication only.

<sup>2</sup> Input 4 controls audible intensity. Apply 12 V DC to 30 V DC for high intensity, or leave floating for low intensity.

<sup>3</sup> Refer to CIE 1931 chromaticity diagram or color chart, to show equivalent color with indicated color coordinates. Actual coordinates may differ by 10%.

## Dimensions

All measurements are listed in millimeters [inches], unless noted otherwise.

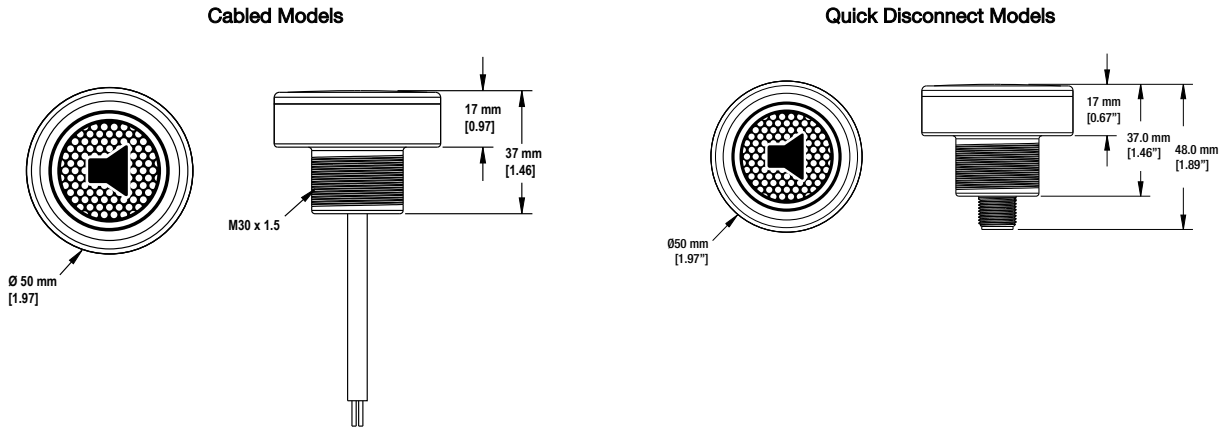

## Accessories

### Pro Editor Hardware

#### MQDC-506-USB

- Pro Converter Cable
- 1.83 m (6 ft) length 5-pin M12 quick disconnect to Device and USB to PC
- Required for connection to Pro Editor

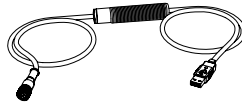

#### CSB-M1251FM1251M

- 5-pin parallel Y splitter (Male-Male-Female)
- For full Pro Editor preview capability
- Requires external power supply, sold separately

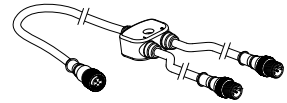

#### PSW-24-1

- 24 V DC, 1 A power supply
- 2 m (6.5 ft) PVC cable with M12 quick disconnect
- Provides external power with splitter cable, sold separately



#### ACC-PRO-CABLES

- Mating accessory for cabled and terminal models
- 150 mm (6 inch) PVC cable with M12 quick disconnect
- Lever wire nuts included (qty 5)
- Required to connect cabled models and screw terminal models to Pro Converter Cable, sold separately

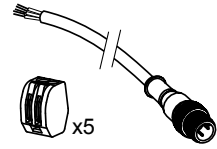

## Cordsets

5-Pin Threaded M12 Cordsets—Single Ended				
Model	Length	Style	Dimensions	Pinout (Female)
MQDC1-501.5	0.5 m (1.5 ft)	Straight		
MQDC1-503	0.9 m (2.9 ft)			
MQDC1-506	2 m (6.5 ft)			
MQDC1-515	5 m (16.4 ft)			
MQDC1-530	9 m (29.5 ft)			
MQDC1-560	18 m (59 ft)			
MQDC1-506RA	2 m (6.5 ft)	Right-Angle		<p>1 = Brown 2 = White 3 = Blue 4 = Black 5 = Gray</p>
MQDC1-515RA	5 m (16.4 ft)			
MQDC1-530RA	9 m (29.5 ft)			
MQDC1-560RA	19 m (62.3 ft)			

5-Pin Threaded M12 Stainless Steel Washdown Cordsets—Single Ended				
Model	Length	Style	Dimensions	Pinout (Female)
MQDC-WDSS-0506	2 m (6.56 ft)	Straight		<p>1 = Brown 2 = White 3 = Blue 4 = Black 5 = Gray</p>
MQDC-WDSS-0515	5 m (16.4 ft)			
MQDC-WDSS-0530	9 m (29.5 ft)			

### Splitter Cables for Use with IO-Blocks

5-Pin Threaded M12 to 4-Pin Threaded M12 Combiner Cordset with Flat Junction																					
Model	Branches (Male)	Trunk (Female)	Pinout																		
CSF-M12F51M12M41	4-pin Quick Disconnect, 2 x 0.31 m (1.02 ft)	5-pin Quick Disconnect, 0.31 m (1.02 ft)	<p>Female</p> <p>Male</p>																		
			<table border="1"> <thead> <tr> <th>Trunk</th> <th>Branch 1</th> <th>Branch 2</th> </tr> </thead> <tbody> <tr> <td>1 = Brown</td> <td>1 = NC</td> <td>1 = NC</td> </tr> <tr> <td>2 = White</td> <td>2 = Brown</td> <td>2 = Gray</td> </tr> <tr> <td>3 = Blue</td> <td>3 = Blue</td> <td>3 = Blue</td> </tr> <tr> <td>4 = Black</td> <td>4 = Black</td> <td>4 = White</td> </tr> <tr> <td>5 = Gray</td> <td></td> <td></td> </tr> </tbody> </table>	Trunk	Branch 1	Branch 2	1 = Brown	1 = NC	1 = NC	2 = White	2 = Brown	2 = Gray	3 = Blue	3 = Blue	3 = Blue	4 = Black	4 = Black	4 = White	5 = Gray		
Trunk	Branch 1	Branch 2																			
1 = Brown	1 = NC	1 = NC																			
2 = White	2 = Brown	2 = Gray																			
3 = Blue	3 = Blue	3 = Blue																			
4 = Black	4 = Black	4 = White																			
5 = Gray																					

### Brackets

#### SMB30A

- Right-angle bracket with curved slot for versatile orientation
- Clearance for M6 (1/4 in) hardware
- Mounting hole for 30 mm sensor
- 12-ga. stainless steel

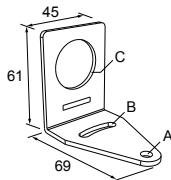

**Hole center spacing:** A to B=40  
**Hole size:** A=ø 6.3, B= 27.1 x 6.3, C=ø 30.5

#### SMB30FVK

- V-clamp, flat bracket and fasteners for mounting to pipe or extensions
- Clamp accommodates 28 mm dia. tubing or 1 in. square extrusions
- 30 mm hole for mounting sensors

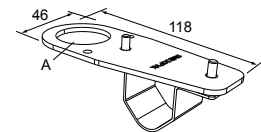

**Hole size:** A= ø 31

#### SMB30RAVK

- V-clamp, right-angle bracket and fasteners for mounting sensors to pipe or extrusion
- Clamp accommodates 28 mm dia. tubing or 1 in. square extrusions
- 30 mm hole for mounting sensors

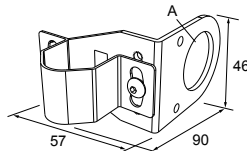

**Hole size:** A = ø 30.5

#### SMBAMS30P

- Flat SMBAMS series bracket
- 30 mm hole for mounting sensors
- Articulation slots for 90°+ rotation
- 12-ga. 300 series stainless steel

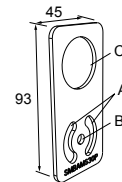

**Hole center spacing:** A=26.0, A to B=13.0  
**Hole size:** A=26.8 x 7.0, B=ø 6.5, C=ø 31.0

**SMBAMS30RA**

- Right-angle SMBAMS series bracket
- 30 mm hole for mounting sensors
- Articulation slots for 90°+ rotation
- 12-ga. (2.6 mm) cold-rolled steel

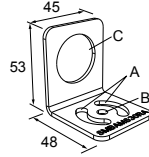

**Hole center spacing:** A=26.0, A to B=13.0  
**Hole size:** A=26.8 x 7.0, B=ø 6.5, C=ø 31.0

**SMB30MM**

- 12-ga. stainless steel bracket with curved mounting slots for versatile orientation
- Clearance for M6 (¼ in) hardware
- Mounting hole for 30 mm sensor

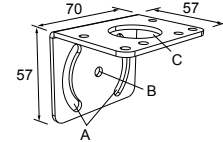

**Hole center spacing:** A = 51, A to B = 25.4  
**Hole size:** A = 42.6 x 7, B = ø 6.4, C = ø 30.1

**SMB30SC**

- Swivel bracket with 30 mm mounting hole for sensor
- Black reinforced thermoplastic polyester
- Stainless steel mounting and swivel locking hardware included

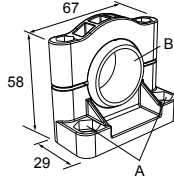

**Hole center spacing:** A=ø 50.8  
**Hole size:** A=ø 7.0, B=ø 30.0

**SMB30FA**

- Swivel bracket with tilt and pan movement for precise adjustment
- Mounting hole for 30 mm sensor
- 12-ga. 304 stainless steel
- Easy sensor mounting to extrude rail T-slot
- Metric and inch size bolt available

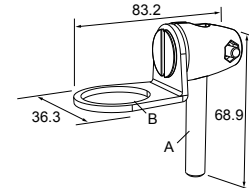

**Bolt thread:** SMB30FA, A= 3/8 - 16 x 2 in; SMB30FAM10, A= M10 - 1.5 x 50  
**Hole size:** B= ø 30.1

**LMBE12RA35**

- Direct mounting of stand-off pipe, with common bracket type
- Zinc-plated steel
- 1/2-14 NPSM nut
- Mounting distance from the wall to the center of the 1/2-14 NPSM nut is 35 mm

Hole center spacing: 20.0

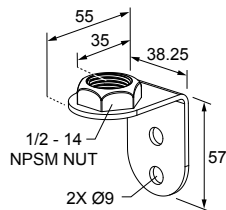
**LMBE12RA45**

- Direct mounting of stand-off pipe, with common bracket type
- Zinc-plated steel
- 1/2-14 NPSM nut
- Mounting distance from the wall to the center of the 1/2-14 NPSM nut is 45 mm

Hole center spacing: 35.0

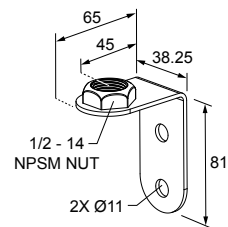

All measurements are listed in millimeters [inches], unless noted otherwise.

## Banner Engineering Corp. Limited Warranty

Banner Engineering Corp. warrants its products to be free from defects in material and workmanship for one year following the date of shipment. Banner Engineering Corp. will repair or replace, free of charge, any product of its manufacture which, at the time it is returned to the factory, is found to have been defective during the warranty period. This warranty does not cover damage or liability for misuse, abuse, or the improper application or installation of the Banner product.

**THIS LIMITED WARRANTY IS EXCLUSIVE AND IN LIEU OF ALL OTHER WARRANTIES WHETHER EXPRESS OR IMPLIED (INCLUDING, WITHOUT LIMITATION, ANY WARRANTY OF MERCHANTABILITY OR FITNESS FOR A PARTICULAR PURPOSE), AND WHETHER ARISING UNDER COURSE OF PERFORMANCE, COURSE OF DEALING OR TRADE USAGE.**

This Warranty is exclusive and limited to repair or, at the discretion of Banner Engineering Corp., replacement. **IN NO EVENT SHALL BANNER ENGINEERING CORP. BE LIABLE TO BUYER OR ANY OTHER PERSON OR ENTITY FOR ANY EXTRA COSTS, EXPENSES, LOSSES, LOSS OF PROFITS, OR ANY INCIDENTAL, CONSEQUENTIAL OR SPECIAL DAMAGES RESULTING FROM ANY PRODUCT DEFECT OR FROM THE USE OR INABILITY TO USE THE PRODUCT, WHETHER ARISING IN CONTRACT OR WARRANTY, STATUTE, TORT, STRICT LIABILITY, NEGLIGENCE, OR OTHERWISE.**

Banner Engineering Corp. reserves the right to change, modify or improve the design of the product without assuming any obligations or liabilities relating to any product previously manufactured by Banner Engineering Corp. Any misuse, abuse, or improper application or installation of this product or use of the product for personal protection applications when the product is identified as not intended for such purposes will void the product warranty. Any modifications to this product without prior express approval by Banner Engineering Corp will void the product warranties. All specifications published in this document are subject to change; Banner reserves the right to modify product specifications or update documentation at any time. Specifications and product information in English supersede that which is provided in any other language. For the most recent version of any documentation, refer to: [www.bannerengineering.com](http://www.bannerengineering.com).

For patent information, see [www.bannerengineering.com/patents](http://www.bannerengineering.com/patents).

## FCC Part 15

This device complies with Part 15 of the FCC Rules. This equipment generates, uses, and can radiate radio frequency energy and, if not installed and used in accordance with the instruction manual, may cause harmful interference to radio communications. Operation is subject to the following two conditions: 1) This device may not cause harmful interference; and 2) This device must accept any interference received, including interference that may cause undesired operation.

## Industry Canada

This device complies with CAN ICES-3 (B)/NMB-3(B). Operation is subject to the following two conditions: 1) This device may not cause harmful interference; and 2) This device must accept any interference received, including interference that may cause undesired operation.

Cet appareil est conforme à la norme NMB-3(B). Le fonctionnement est soumis aux deux conditions suivantes : (1) ce dispositif ne peut pas occasionner d'interférences, et (2) il doit tolérer toute interférence, y compris celles susceptibles de provoquer un fonctionnement non souhaité du dispositif.