

OPTION



New product presentation & Use Cases

July 2020

OPTION, a Crescent Company

Smart Metering Expansion Card

Smart Metering Expansion Card – Commercial

- **Targeted market verticals :**
 - Utilities
 - Building
- **Typical customers:**
 - Companies concerned by water, gas, electricity & heat metering.
 - Smart Building system integrators.
- **Basics: covers wired interface needs**
 - Modbus interface
 - M-Bus interface
 - P1/DSMR interface
 - I2C sensor interface
 - USB interface
 - 5 x configurable GPIO
- **Type of Card:**
 - Front slot expansion card
- **Availability:**
 - In production
 - Permanent portofolio product.
- **Warranty:**
 - 2 years.

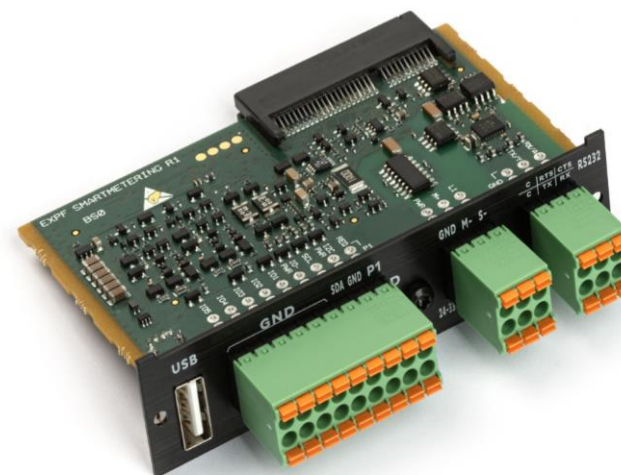

Smart Metering Expansion Card – Use cases

- **Ideal for :**
 - Smart building monitoring
 - Indoor & street cabinet monitoring
 - Energy optimization
- **Selling points:**
 - Interface with all wired sensors used by meters.
 - Monitoring of critical sensors, analog or digital inputs.
 - Triggering of digital outputs.
 - Can be combined with wireless connectivity cards (LoRaWAN, Zigbee, wM-Bus,...).
 - Can be interfaced to the BACnet building management system, remote access etc.
 - Interesting to be combined with our optional BACnet node in LuvitRED.
 - In case of power loss, the gateway and the card can continue working for 30 minutes to 1 hour with our optional CloudGate battery.
 - Remark: if the battery is installed, the USB & Master M-Bus functionalities can't be used (power supply).

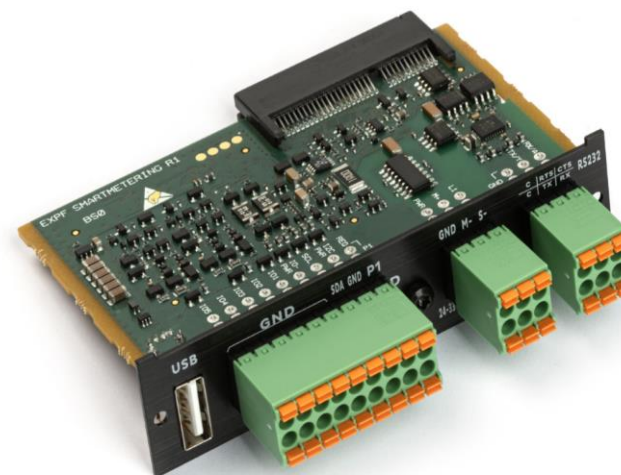

Smart Metering Expansion Card – Detailed Specifications

- **Connectors**

- The interfaces available on the card use a pluggable connector of the type: DFMC 1,5-3,5

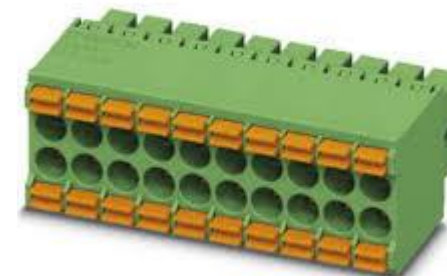

- **IO connector (18 pins) for wired interfaces**

- I2C interface 3.3V for environmental sensors used in electricity cabinets (temp, humidity) - 4 pins
- 5 multi-purpose IO's to monitor alarms in electricity cabinets or drive relays - 11 pins
 - Digital input (0 - 30V, including dry-contact pulse counter)
 - Analog input (0 - 10V)
 - Current Loop input (4 – 20mA)
 - S0 pulse-counter input
 - Digital output (0 – 3.3V)
 - Open Drain output (< 250mA, 0 – 30V)
- P1 interface(for electricity meters in BE/NL)

| | | | | | | | | |
|-----|-----|-----|-----|-----|-----|-----|-----|-----|
| GND | GND | GND | GND | GND | GND | SDA | GND | P1D |
| IO5 | IO4 | IO3 | IO2 | IO1 | PWR | SCL | 3V3 | P1R |

- **M-Bus connector**

- This board contains an Mbus Master circuit and a separate Mbus Slave circuit.
- Mbus Master : up to 250 unit loads with 30V power supply, 64 unit loads with 24V power supply or Mbus Slave
- Power supply + GND pin for Mbus master (also powering CG).

| | | |
|-----|----|----|
| GND | M- | S- |
| VDC | M+ | S+ |

Smart Metering Expansion Card – Detailed Specifications

- **Serial connector (5 pins)**
 - 2kV galvanically isolated, can be configured for:
 - RS232 (Rx/Tx/RTS/CTS/GND) – 500Kbaud max;
 - RS422
 - RS485 (full or half duplex A/B/GND).
 - Switch for RS485 termination configurable in LuvitRED.
- **USB Port**



RS232

| | | |
|---|-----|-----|
| C | RTS | CTS |
| C | TX | RX |

RS485 half duplex

| | | |
|---|-----|----|
| C | HD- | NC |
| C | HD+ | NC |

RS485 full duplex

| | | |
|---|-----|-----|
| C | TA- | RA- |
| C | TA+ | RA+ |

WARNING !

- Smart Metering Card Mbus Master functionality is not compatible with CloudGate types:
 - CG0112 → CloudGate 3G EMEA
 - CG0122 → CloudGate 3G Japan
 - CG0192 → CloudGate 3G America
 - → Replaced by the CloudGate LTE WW CG0124-12135
- M-Bus Master requires the CloudGate to be powered using the VDC and GND pins of this expansion card. The power supply should be 30V 1A. The original power connector must be left unconnected.

Smart Metering Expansion Card – Detailed Specifications

| | |
|--------------|---|
| Serial port | <ul style="list-style-type: none"> • 6-pins, 2kV galvanically isolated • RS232 (Rx/Tx/RTS/CTS/GND) – 500Kbaud max or • RS422 or • RS485 (full or half duplex A/B/GND) • Switch for RS485 termination available in the UI* <p>*not applicable to CloudGate R1</p> |
| Mbus port | <ul style="list-style-type: none"> • Mbus Master <ul style="list-style-type: none"> • up to 250 unit loads with 30V power supply • up to 64 unit loads with 24V power supply or • Mbus Slave • Power supply + GND pin for Mbus master. These pins are also powering CloudGate so no separate power supply is needed. |
| IO port | <ul style="list-style-type: none"> • 18-pins connector for wired interfaces • I2C interface 3.3V eg for environmental sensors in electricity cabinet (temp, humidity etc) - 4 pins • 5 multi-purpose IO's eg to monitor alarms in electricity cabinet or to drive door opening/ventilation relays - 11 pins <ul style="list-style-type: none"> • Digital input (0 - 30V) (including dry-contact pulse counter) • Analog input (0 - 10V) • Current Loop input (4 – 20mA) • S0 pulse-counter input • Digital output (0 – 3.3V) • Open Drain output (< 250mA, 0 – 30V) • P1 interface (for electricity meters in BE/NL) - 3 pins |
| USB 2.0 port | ✓ |
| Connectors | <ul style="list-style-type: none"> • 6-pin : PHOENIX-1786840-3V + PHOENIX-1790111-3V • 20-pin : PHOENIX-1786918-10V + PHOENIX-1790182-10V • 3 connectors 6P are included with the card |

Smart Metering Expansion Card – About M-Bus

- M-Bus (Meter-Bus) is a European standard (EN 13757) for the remote reading of water meter, gas, heat or electricity meters. A radio variant of M-Bus (Wireless M-Bus) is also specified in the standard.
- The M-Bus interface is made for communication on two wires, making it cost-effective.
- Some setup information:
 - Up to 250 slaves can communicate in one M-Bus segment. M-Bus repeaters are needed if there are more slaves that need to be connected.
 - A two-wire standard telephone cable (2*0.8 mm) is used as the transmission medium for the M-Bus.
 - The maximum distance between a slave and the repeater is 350 m. In the standard configuration the total cable length should not exceed 1000 m.
 - The slaves require a maximum constant current of 1.5 mA each. The bus voltage needs to be between 21 V and 42 V.

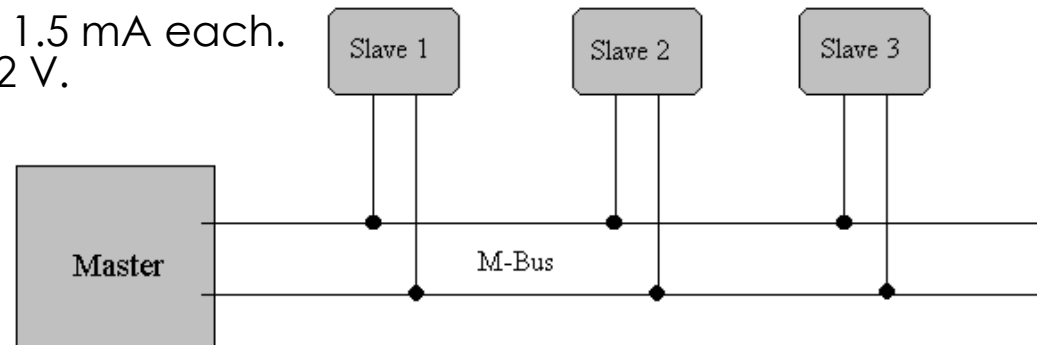

- In a typical setup, CloudGate is the M-Bus master but we can also be an M-Bus slave in a setup where there is already a master present. If we need to be M-Bus master, a power supply of 30V is required.

Smart Metering Expansion Card – Use Case 1

- **M-Bus master for apartment buildings**
- Every apartment has a separate water meter, concentrated per floor in a water meter room
- M-Bus connection line runs from CloudGate to all these water meters, providing power to the meters and reading the metering info.
- Smart Metering card can connect up to 250 of these water meters (assumption: 1 meter = 1 unit load).



GND
Power (24 to 33V)

M-Bus -
M-Bus +



Smart Metering Expansion Card – Use Case 2

- Smart meter data concentrator
- M-Bus data concentrator for wired and wireless water meters
- Modbus gateway for smart electricity meters

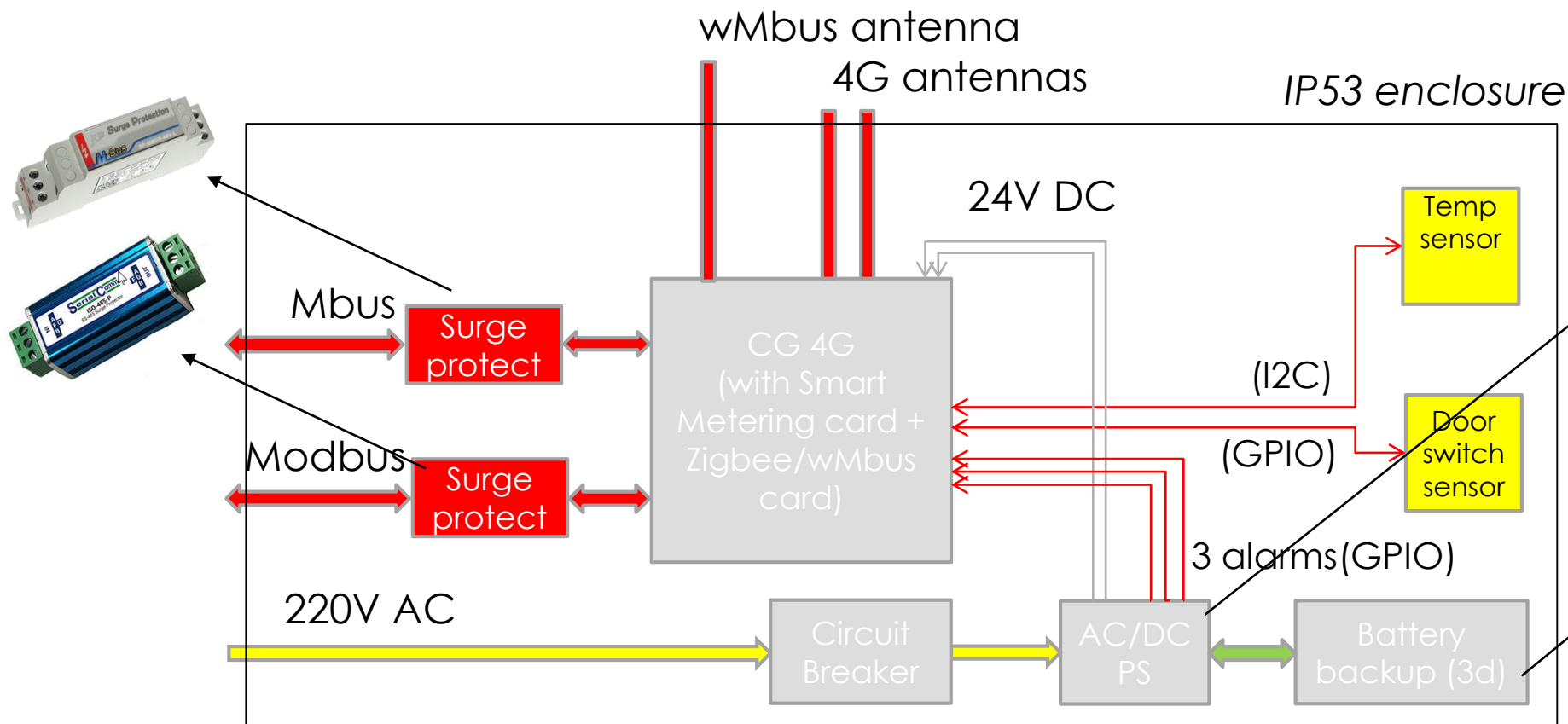

- 24V, 75W
1. Battery discharge
 2. Battery fail
 3. DC bus NOK



24V, 4.5Ah

Smart Metering Expansion Card – Use Case 3

- Energy management in buildings (BE)

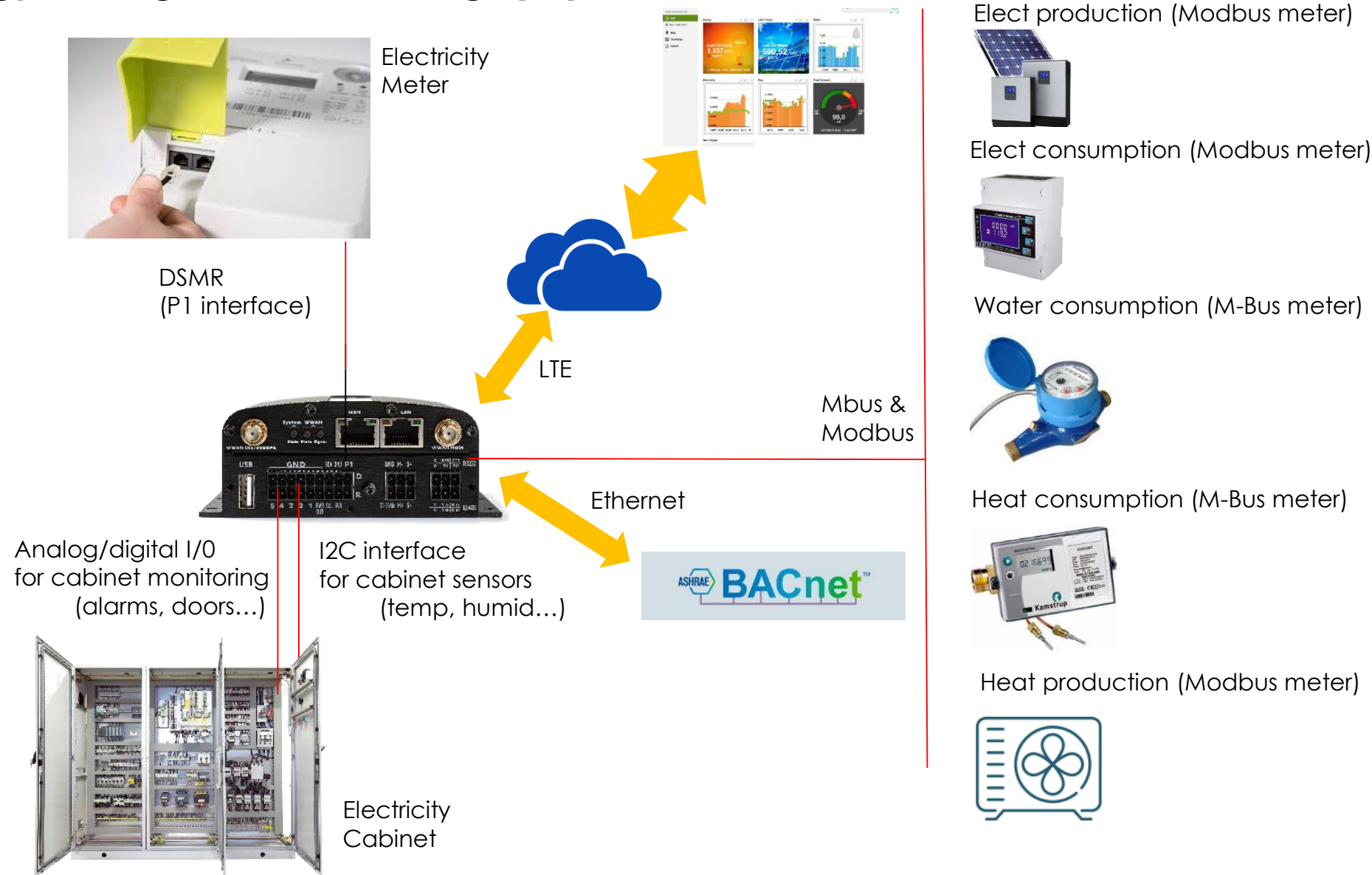

Smart Metering Expansion Card – Order information

- **Reference number for ordering:**
 - CG1124-12154
- **Documentation page on CloudGate Universe:**
 - <https://cloudgateuniverse.com/docs/smart-meterir>

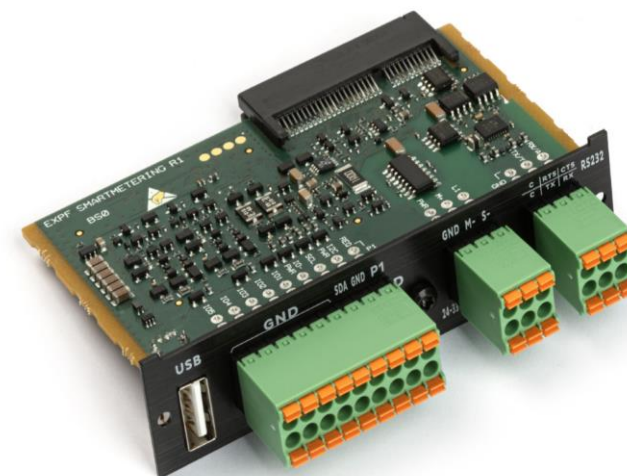

PDF File

Option knows how

OPTION

+32 16 317 411

s.pillons@option.com

Gaston Geenslaan 14

3001 Leuven (BE)