

Data sheet | Item number: 2092-3502/002-000

1-conductor male connector; Push-in CAGE CLAMP®; 2.5 mm<sup>2</sup>; Pin spacing 7.5 mm; 2-pole; Gripping plate; 2,50 mm<sup>2</sup>; light gray



[www.wago.com/2092-3502/002-000](http://www.wago.com/2092-3502/002-000)



**i** Picture differs from the item.

Color:

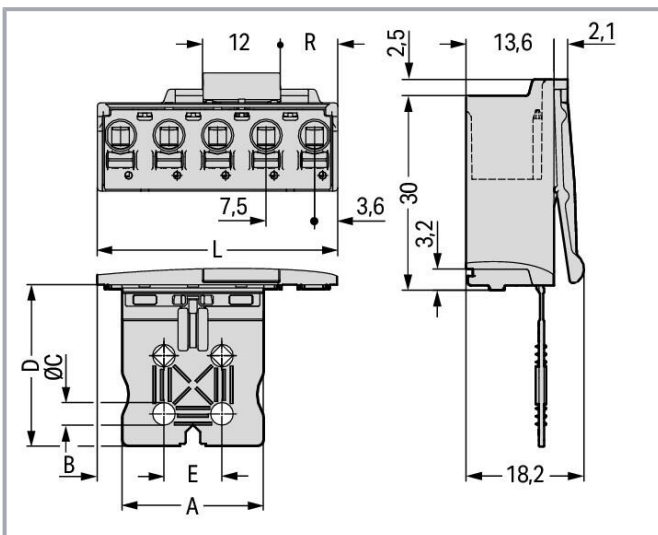
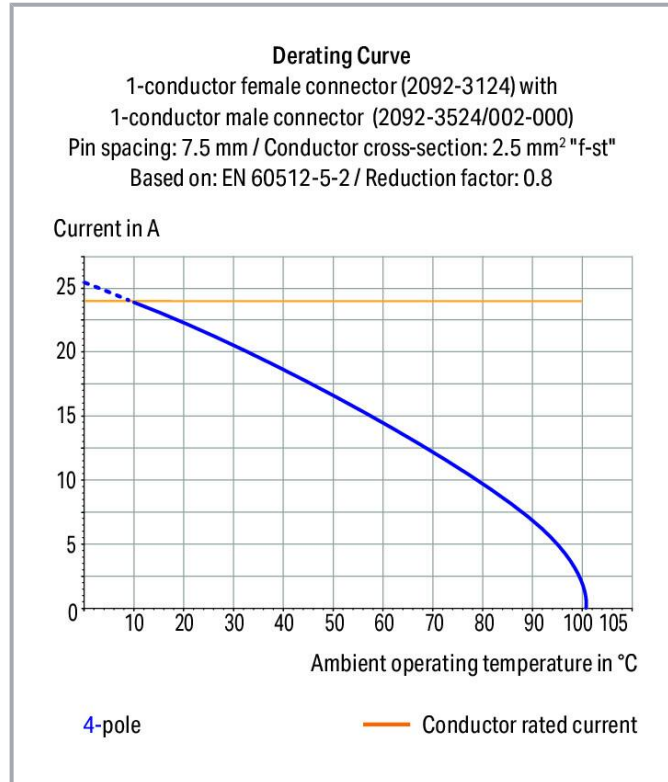

Subject to changes. Please also observe the further product documentation!

WAGO GmbH & Co. KG  
Hansastr. 27  
32423 Minden  
Phone: +49571 887-0 | Fax: +49571 887-169  
Email: [info.de@wago.com](mailto:info.de@wago.com) | Web: [www.wago.com](http://www.wago.com)

Do you have any questions about our products?  
We are always happy to take your call at +49 (571) 887-44222.



## Item description

- Universal connection for all conductor types
- Simple, push-in termination of solid and ferruled conductors
- Easy-to-use design does not require special tools
- Testing parallel to conductor entry – tip contact
- For “wire-to-wire” and “board-to-wire” connections
- Integrated release lever

## Data

### Notes

#### Safety information

The **picoMAX® Pluggable Connection System** includes connectors without breaking capacity in accordance with DIN EN 61984. When used as intended, these connectors must not be connected /disconnected when live or under load. The circuit design should ensure header pins, which can be touched, are not live when unmated.

#### Variants:

Direct marking

Other versions (or variants) can be requested from WAGO Sales or configured at <https://configurator.wago.com/>.

## Electrical data

### Ratings per IEC/EN

Ratings per	IEC/EN 60664-1
Nominal voltage (III/3)	400 V
Rated impulse voltage (III/3)	6 kV
Rated voltage (III/2)	630 V
Rated impulse voltage (III/2)	6 kV
Nominal voltage (II/2)	1000 V
Rated surge voltage (II/2)	6 kV
Rated current	16 A
Legend (ratings)	(III / 2) ≙ Overvoltage category III / Pollution degree 2

### Ratings per UL 1059

Approvals per	UL 1059
Rated voltage UL (Use Group B)	300 V
Rated current UL (Use Group B)	15 A

Subject to changes. Please also observe the further product documentation!

WAGO GmbH & Co. KG

Hansastr. 27

32423 Minden

Phone: +49571 887-0 | Fax: +49571 887-169

Email: [info.de@wago.com](mailto:info.de@wago.com) | Web: [www.wago.com](http://www.wago.com)

Do you have any questions about our products?

We are always happy to take your call at +49 (571) 887-44222.



Rated voltage UL (Use Group D)	300 V
Rated current UL (Use Group D)	10 A

### Connection data

Connection points	2
Total number of potentials	2
Number of connection types	1
Number of levels	1

### Connection 1

Connection technology	Push-in CAGE CLAMP®
Actuation type	Push-button
Actuation direction 1	Operation parallel to conductor entry
Solid conductor	0.2 ... 2.5 mm <sup>2</sup> / 24 ... 12 AWG
Fine-stranded conductor	0.2 ... 2.5 mm <sup>2</sup> / 24 ... 12 AWG
Fine-stranded conductor; with insulated ferrule	0.25 ... 1.5 mm <sup>2</sup>
Fine-stranded conductor; with uninsulated ferrule	0.25 ... 2.5 mm <sup>2</sup>
Strip length	9 ... 10 mm / 0.35 ... 0.39 inches
Pole number	2

### Physical data

Pin spacing	7.5 mm / 0.295 inches
Width	14.7 mm / 0.579 inches
Height	18.2 mm / 0.717 inches
Depth	51.8 mm / 2.039 inches

### Mechanical Data

Variable coding	Yes
Design	With gripping plate
Anti-rotation protection	Yes

### Plug-in connection

Contact type (pluggable connector)	Male connector/plug
Connector (connection type)	for conductor
Mismatching protection	No
Plugging without loss of pin spacing	Yes

Subject to changes. Please also observe the further product documentation!



Locking of plug-in connection

Locking latch

## Material Data

Note (material data)

Information on material specifications can be found here

Color	light gray
Material group	I
Insulation material	Polyphthalamide (PPA GF)
Flammability class per UL94	V0
Clamping spring material	Chrome-nickel spring steel (CrNi)
Contact material	Electrolytic copper (E <sub>Cu</sub> )
Contact plating	Tin
Fire load	0.033 MJ
Weight	5.8 g

## Environmental requirements

Limit temperature range	-60 ... +100 °C
Processing temperature	-35 ... +60 °C

## Commercial data

Product Group	26 (picoMAX Connectors)
eCl@ss 10.0	27-14-11-06
eCl@ss 9.0	27-14-11-06
ETIM 8.0	EC001284
ETIM 7.0	EC001284
PU (SPU)	100 pcs
Packaging type	box
Country of origin	DE
GTIN	4050821164791
Customs tariff number	85366990990





## Environmental Product Compliance

RoHS Compliance Status	Compliant, No Exemption
------------------------	-------------------------

Subject to changes. Please also observe the further product documentation!

## Approvals / Certificates

### General approvals

Logo	Approval	Additional Approval Text	Certificate name
	CSA DEKRA Certification B.V.	C22.2 No. 158	2362521
	CSA DEKRA Certification B.V.	C22.2	2362521
	cURus Underwriters Laboratories Inc.	UL 1059	E45172
	KEMA/KEUR DEKRA Certification B.V.	EN 61984	71- 102261 REV.2
	UL Underwriters Laboratories Inc.	UL 1977	E45171

### Counterpart

**Item no.2092-3122**

1-conductor female connector; push-button; Push-in CAGE CLAMP®; 2.5 mm<sup>2</sup>; Pin spacing 7.5 mm; 2-pole; 2,50 mm<sup>2</sup>; light gray

[www.wago.com/2092-3122](http://www.wago.com/2092-3122)

**Item no.2092-3302**

THT female header; straight; Pin spacing 7.5 mm; 2-pole; 0.4 x 1.3 mm solder pin; light gray

[www.wago.com/2092-3302](http://www.wago.com/2092-3302)

**Item no.2092-3302/200-000**

THR female header; straight; Pin spacing 7.5 mm; 2-pole; 0.4 x 1.3 mm solder pin; light gray

[www.wago.com/2092-3302/200-000](http://www.wago.com/2092-3302/200-000)

Subject to changes. Please also observe the further product documentation!

WAGO GmbH & Co. KG

Hansastr. 27

32423 Minden

Phone: +49571 887-0 | Fax: +49571 887-169

Email: [info.de@wago.com](mailto:info.de@wago.com) | Web: [www.wago.com](http://www.wago.com)

Do you have any questions about our products?

We are always happy to take your call at +49 (571) 887-44222.



**Item no.2092-3322**

THT female header; angled; Pin spacing 7.5 mm; 2-pole; 0.4 x 1.3 mm solder pin; light gray

[www.wago.com/2092-3322](http://www.wago.com/2092-3322)



**Item no.2092-3322/200-000**

THR female header; angled; Pin spacing 7.5 mm; 2-pole; 0.4 x 1.3 mm solder pin; light gray

[www.wago.com/2092-3322/200-000](http://www.wago.com/2092-3322/200-000)



**Item no.2092-3102**

1-conductor female connector; push-button; Push-in CAGE CLAMP®; 2.5 mm²; Pin spacing 7.5 mm; 2-pole; Gripping plate; 2,50 mm²; light gray

[www.wago.com/2092-3102](http://www.wago.com/2092-3102)



**Item no.2092-3122/000-9500**

1-conductor female connector; push-button; Push-in CAGE CLAMP®; 2.5 mm²; Pin spacing 7.5 mm; 2-pole; direct marking; 2,50 mm²; light gray

[www.wago.com/2092-3122/000-9500](http://www.wago.com/2092-3122/000-9500)



**Item no.2092-3122/000-9501**

1-conductor female connector; push-button; Push-in CAGE CLAMP®; 2.5 mm²; Pin spacing 7.5 mm; 2-pole; direct marking; 2,50 mm²; light gray

[www.wago.com/2092-3122/000-9501](http://www.wago.com/2092-3122/000-9501)

## Downloads

### Documentation

#### Additional Information

Technical Section	2019 Apr 3	pdf	Download
Technical explanations		2.0 MB	

## CAD/CAE-Data

### CAE data

ZUKEN Portal 2092-3502/002-000	URL	Download
--------------------------------	-----	----------

### CAD data

2D/3D Models 2092-3502/002-000	URL	Download
--------------------------------	-----	----------

## Environmental Product Compliance

### Compliance Search

Environmental Product Compliance 2092-3502/002-000	URL	Download
--	-----	----------

Subject to changes. Please also observe the further product documentation!



1-conductor male connector; Push-in CAGE CLAMP®; 2.5 mm<sup>2</sup>; Pin spacing 7.5 mm;  
2-pole; Gripping plate; 2,50 mm<sup>2</sup>; light gray

---

## Installation Notes

Subject to changes. Please also observe the further product documentation!

---

WAGO GmbH & Co. KG  
Hansastr. 27  
32423 Minden  
Phone: +49571 887-0 | Fax: +49571 887-169  
Email: [info.de@wago.com](mailto:info.de@wago.com) | Web: [www.wago.com](http://www.wago.com)

Do you have any questions about our products?  
We are always happy to take your call at +49 (571) 887-44222.