

Mechanical Dimensions (mm)

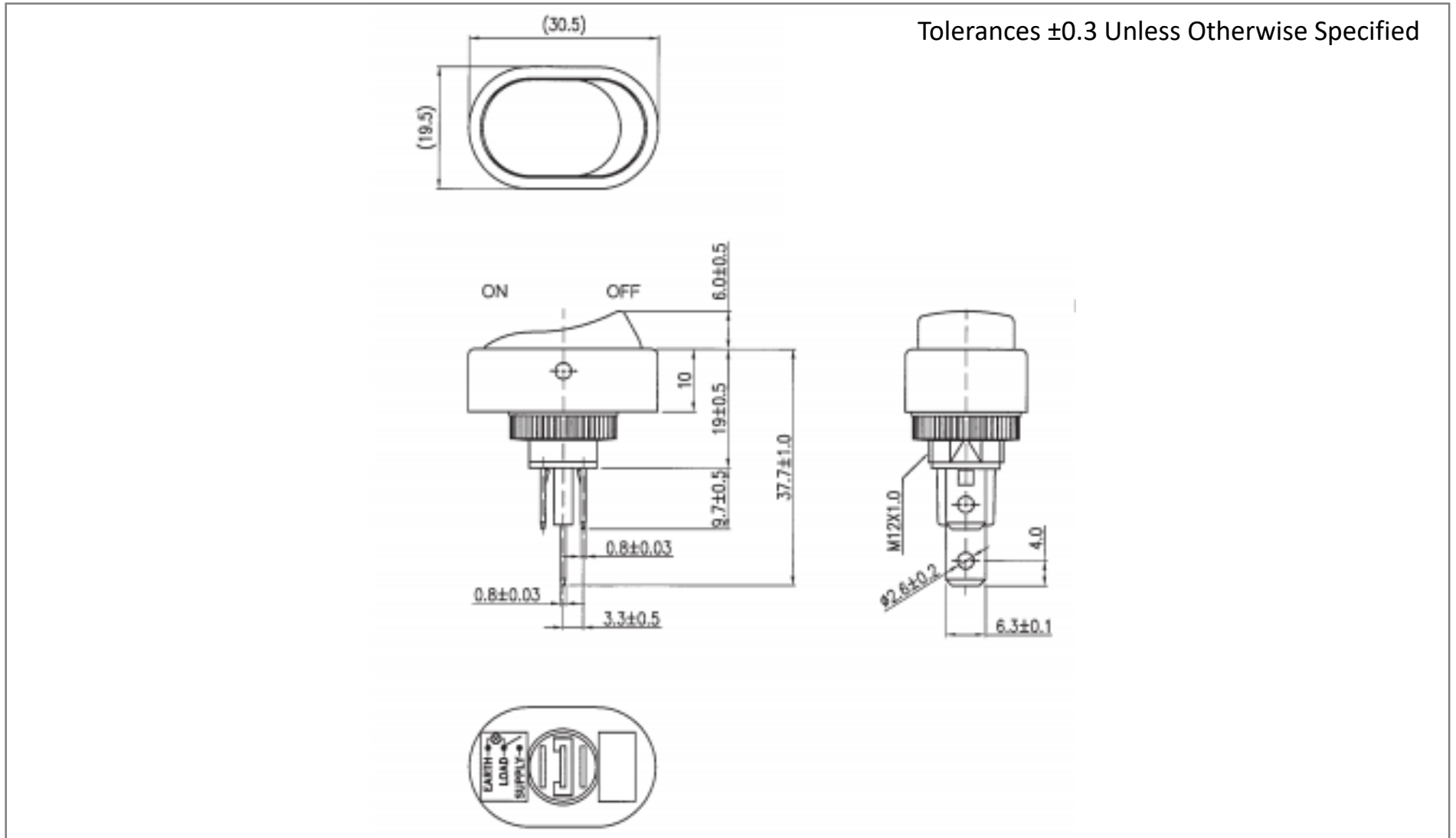

Mounting Hole

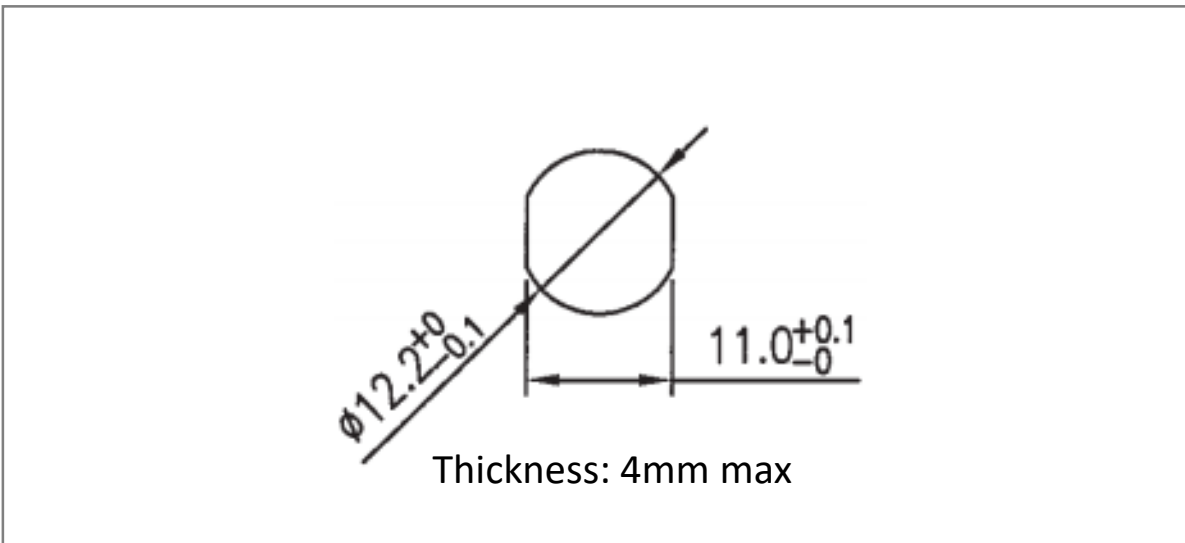

Circuit Diagram

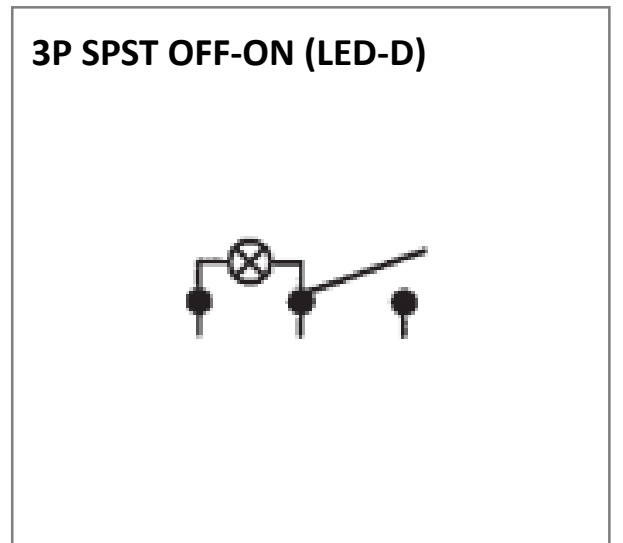

Electrical Specifications

Rating	30A 12V DC
Contact Resistance	50m ohm Max.
Insulation Resistance	DC 500V 100M ohm Min.
Dielectric Strength	AC 1500V 1 minute
Operation Temperature	-25°C~85°C

Material Specifications

Frame	Black, Nylon 66
Actuator	Red clear, PC
LED	Red (Dependent)