

FUSEHOLDERS

Accessories

Accessories for fuseholders



Anti-rotation washer for fuseholders for round mounting holes

Order No.
0696.0033 *

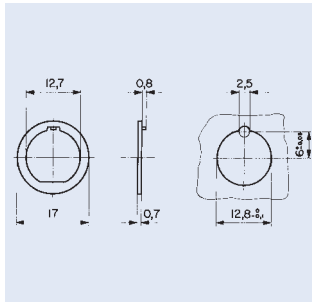

Transparent cover
0853.0551



Reflow-Cover
0853.0571

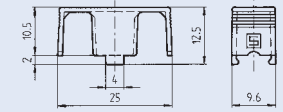

Order No.
0853.0551 * / 0853.0571 *



Reflow-Cover with clamp
0853.0576

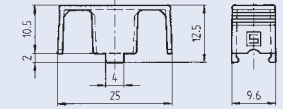

Order No.
0853.0576 *



0583.0007

Metal nut

Order No.
0098.0026 *

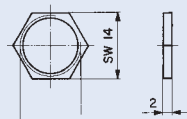

M 12,7 x 1,5
double start thread



Marking plate self-adhesive

Order No.
0880.0001 *

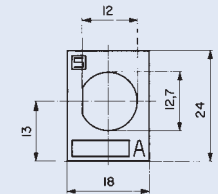

0583.0016

Plastic-nut (max. torque 1,2 Nm)

Order No.
0098.0093 *

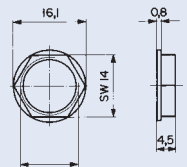

M 12,7 x 1,5
double start thread



Marking plate self-adhesive

Order No.
0880.0002 *

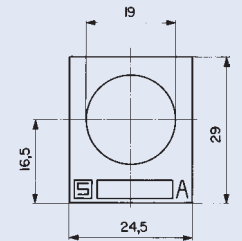

straight

Screw-adapter for quick connect-terminals 6,3 x 0,8 mm

Order No.
0750.0141 *

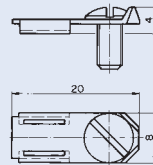

Insulating covers

a) to fuseholder types FIZ/FUL



b) to fuseholders with a socket diameter of 13 mm

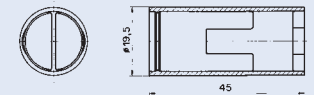

angled

Screw-adapter for quick connect-terminals 6,3 x 0,8 mm

Order No.
0750.0142 *

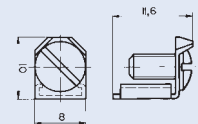

Order No.
a) 0859.0046 *
b) 0859.0080 *

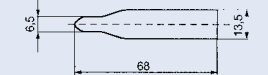

Cover for fuseholders
OG 0751.0052/62,
UHB 0031.5101, OG 0031.8001,
UH 0031.5001, 0031.5010

Order No.
0853.9561 * 1,6 W
0853.9562 * 2,5 W

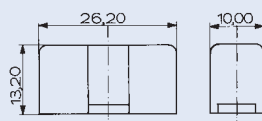

Insulating cover for fuseholders FEU

Order No.
0859.0041 for FEU 0031.1653 *
0859.0042 for FEU 0031.1673 *
0031.1681 *
0859.0043 for FEU 0031.1694 *

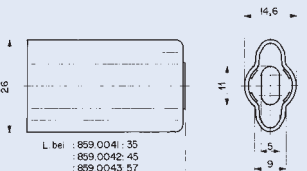

* Packaging unit 100 pieces