

Model Number	Description	Voltage	Max. Load (Convection) (152W) @50°C	Max. Load (Convection) (160W) @40°C	Max. Load (13 CFM)	Min. Load	Ripple ¹	Signals
MULP275-1012	with Screw Terminal	12 V	12.50A	13.33A	22.92A	0.0 A	2%	N.A
MULP275-1312	with Molex Connector	12 V	12.50A	13.33A	22.92A	0.0 A	2%	N.A
MULP275-1015	with Screw Terminal	15 V	10.00A	10.66A	18.33A	0.0 A	2%	N.A
MULP275-1315	with Molex Connector	15 V	10.00A	10.66A	18.33A	0.0 A	2%	N.A
MULP275-1024	with Screw Terminal	24 V	6.25A	6.67A	11.46A	0.0 A	1%	N.A
MULP275-1324	with Molex Connector	24 V	6.25A	6.67A	11.46A	0.0 A	1%	N.A
MULP275-1030	with Screw Terminal	30 V	5.00A	5.33A	9.17A	0.0 A	1%	N.A
MULP275-1330	with Molex Connector	30 V	5.00A	5.33A	9.17A	0.0 A	1%	N.A
MULP275-1048	with Screw Terminal	48 V	3.12A	3.33A	5.73A	0.0 A	1%	N.A
MULP275-1348	with Molex Connector	48 V	3.12A	3.33A	5.73A	0.0 A	1%	N.A
MULP275-1058	with Screw Terminal	58 V	2.58A	2.76A	4.74A	0.0 A	1%	N.A
MULP275-1358	with Molex Connector	58 V	2.58A	2.76A	4.74A	0.0 A	1%	N.A
ULP275-CK metal cover kit accessory								
MULP275-0012	with Screw Terminal	12 V	12.50A	13.33A	22.92A	0.0 A	2%	PG & AC PF ¹⁰
MULP275-0312	with Molex Connector	12 V	12.50A	13.33A	22.92A	0.0 A	2%	PG & AC PF ¹⁰
MULP275-0015	with Screw Terminal	15 V	10.00A	10.66A	18.33A	0.0 A	2%	PG & AC PF ¹⁰
MULP275-0315	with Molex Connector	15 V	10.00A	10.66A	18.33A	0.0 A	2%	PG & AC PF ¹⁰
MULP275-0024	with Screw Terminal	24 V	6.25A	6.67A	11.46A	0.0 A	1%	PG & AC PF ¹⁰
MULP275-0324	with Molex Connector	24 V	6.25A	6.67A	11.46A	0.0 A	1%	PG & AC PF ¹⁰
MULP275-0030	with Screw Terminal	30 V	5.00A	5.33A	9.17A	0.0 A	1%	PG & AC PF ¹⁰
MULP275-0330	with Molex Connector	30 V	5.00A	5.33A	9.17A	0.0 A	1%	PG & AC PF ¹⁰
MULP275-0048	with Screw Terminal	48 V	3.12A	3.33A	5.73A	0.0 A	1%	PG & AC PF ¹⁰
MULP275-0348	with Molex Connector	48 V	3.12A	3.33A	5.73A	0.0 A	1%	PG & AC PF ¹⁰
MULP275-0058	with Screw Terminal	58 V	2.58A	2.76A	4.74A	0.0 A	1%	PG & AC PF ¹⁰
MULP275-0358	with Molex Connector	58 V	2.58A	2.76A	4.74A	0.0 A	1%	PG & AC PF ¹⁰
ULP275-CKP metal cover kit accessory								

Connectors		
J1	Pin 1	AC LINE
	Pin 2	NOT FITTED
	Pin 3	AC NEUTRAL
J2 Option 1 & 2	Pin 1,2,3	V1 +VE
	Pin 4,5,6	V1 -VE
J3	Pin 1	FAN +VE
	Pin 2	FAN -VE
J4 (For PGPF Option Only)	Pin 1	Vs
	Pin 2	PGPF
	Pin 3	GND



Innovations in Power

Notes

1. Ripple is peak to peak with 20 MHz bandwidth and $10\ \mu\text{F}$ (Tantalum capacitor) in parallel with a $0.1\ \mu\text{F}$ capacitor at rated line voltage and load ranges.
2. Class II means without input Earth pin.
3. Combined output power of main output, fan supply shall not exceed max. Power rating.
4. Fan supply output voltage tolerance including set point accuracy, line and load regulation is $\pm 10\%$ and Ripple and noise is less than 10%.
5. Specifications are for nominal input voltage, 25°C unless otherwise stated.
6. 275W with 13CFM forced air cooling and 160W with natural convection cooling at 100 to 264VAC.
7. Output ripple can be more than 10% of the output voltage.
8. Adjustment potentiometer is located on the SMT side of the PCB.
9. When used in Cover Kit, de-rate output power to 70 % under all operating conditions
10. A TTL signal is available at pin 2 of J4 which goes high 100-500mS after output voltage reaches 90% of set value. It goes low a minimum of 1mS before output falls below 90% of the set value, when input AC is switched off.

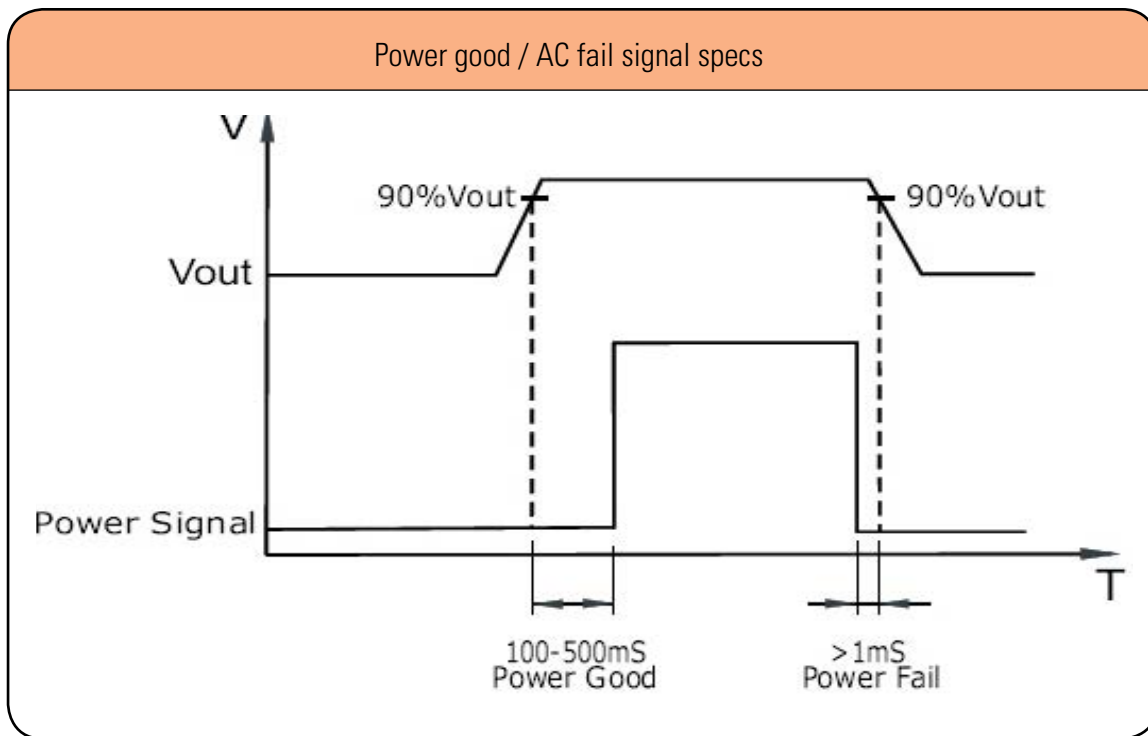

Mechanical Specifications

AC Input Connector (J1)	Molex: 26-60-4030 Mating: 09-50-3031; Pins: 08-50-0106
DC Output Connector (J2) Option 1 (Screw Terminal)	Molex: 39357 Series or equivalent
DC Output Connector (J2) Option 2 (Molex Connector)	Molex: 26-60-4060 Mating: 09-50-3061; Pins: 08-50-0106
Aux (Fan) Output(J3)	AMP :640456-2 Mating: 640440-2
Signal Output (J4)	AMP :640456-3 Mating: 640440-3
Dimensions	5 x 3 x 0.75 inches (127 x 76.2x 19.05 mm)
Weight	200 gm approx

EMC

Parameter	Conditions/Description	Criteria
Conducted Emissions	EN 55011-B,CISPR22-B, FCC PART15-B	Pass
Radiated Emissions	EN 55011 A	Pass (Level B with external core (King core K5B RC 25x12x15-M in input cable))
Input Current Harmonics	EN 61000-3-2	Class D
Voltage Fluctuation and Flicker	EN 61000-3-3	Pass
ESD Immunity	EN 61000-4-2	Level 4, Criterion A
Radiated Field Immunity	EN 61000-4-3	Level 3, Criterion A
Electrical Fast Transient Immunity	EN 61000-4-4	Level 3, Criterion A
Surge Immunity	EN 61000-4-5	Level 3, Criterion A
Conducted Immunity	EN 61000-4-6	Level 3, Criterion A
Magnetic Field Immunity	EN 61000-4-8	Level 4, Criterion A
Voltage dips, interruptions	EN 61000-4-11	Criterion B

Safety

CE Mark	Complies with LVD Directive
Approval Agency	Nemko, UL, C-UL
Safety Standard(s)	EN60601-1, IEC 60601-1 (ed.3), ANSI / AAMI ES 60601 - 1, CSA C22.2 No. 60601-1
Safety File Number(s)	Class-I : UL: E173812,VOL D1, Nemko: Certificate No: P16221541, CB Test Certificate No : NO94798 Class-II : UL: E173812,VOL D1, Nemko: Certificate No: P16221548, CB Test Certificate No: NO94849



Innovations in Power

Derating Curve

Power de-rating

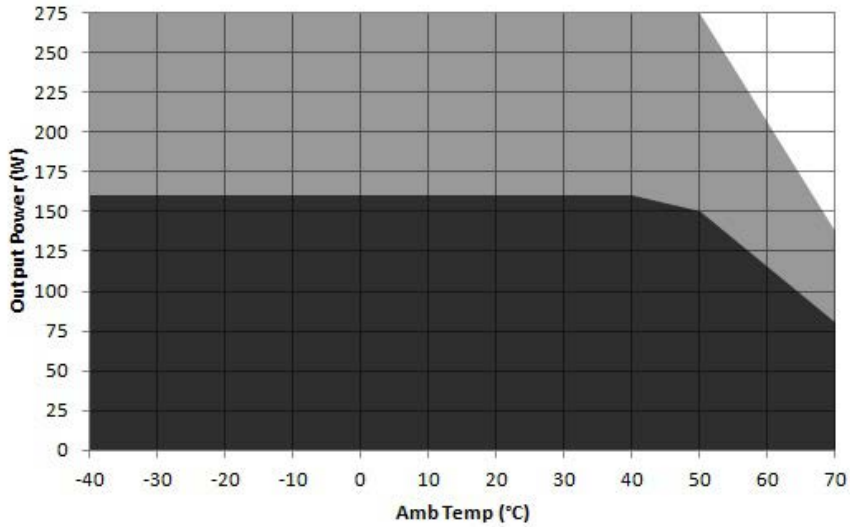

Convection load: 160W up to 40 °C
 De-rate between 40-50 °C @ 0.625% per °C
 De-rate above 50 °C @ 2.33% per °C

Forced air cooled load : 275W up to 50°C
 De-rate above 50 °C @ 2.5% per °C

Power de-rating : w.r.t. Input

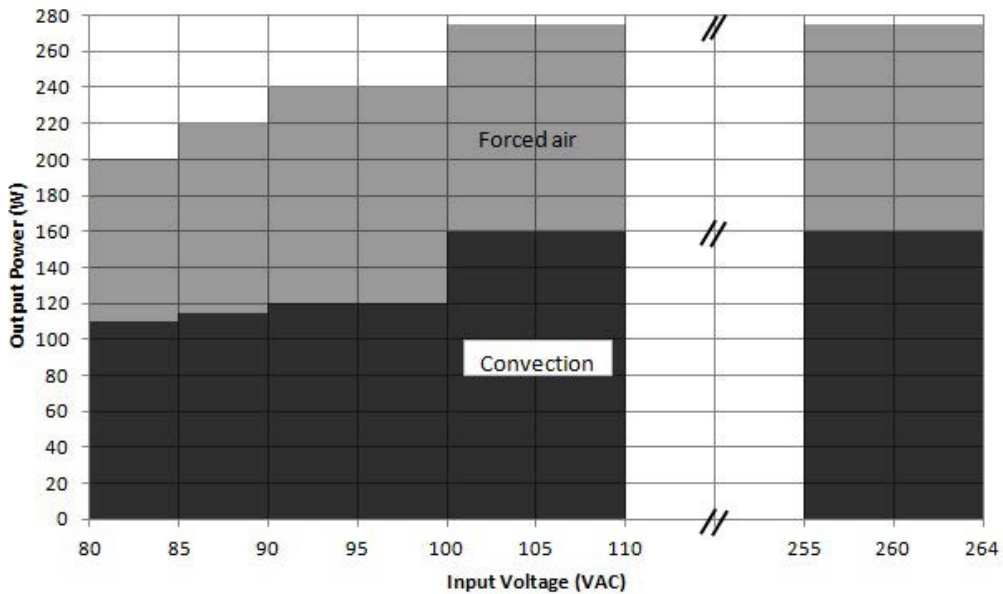

Mechanical Drawing

Option 1 (Without PGPF)

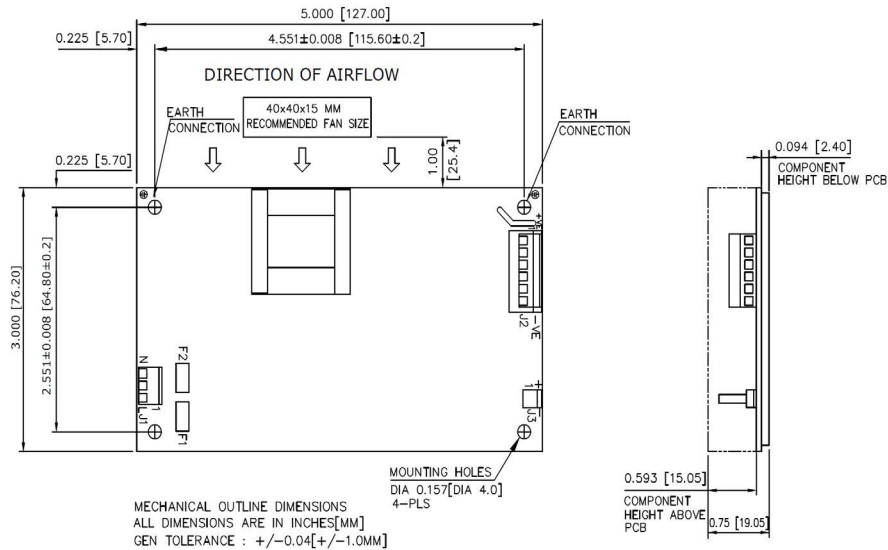

Notes: In case the PCB is mounted in a metal enclosure, using metal hardware ensure the following

1. Stand off, used to mount PCB has OD of 5.4 mm max.
2. Screws, used to fix PCB on stand off, have head dia of 6.0 mm max.
3. Washer, if used, to have dia of 6.5 mm max.

Mechanical Drawing

Option 2 (Without PGPF)

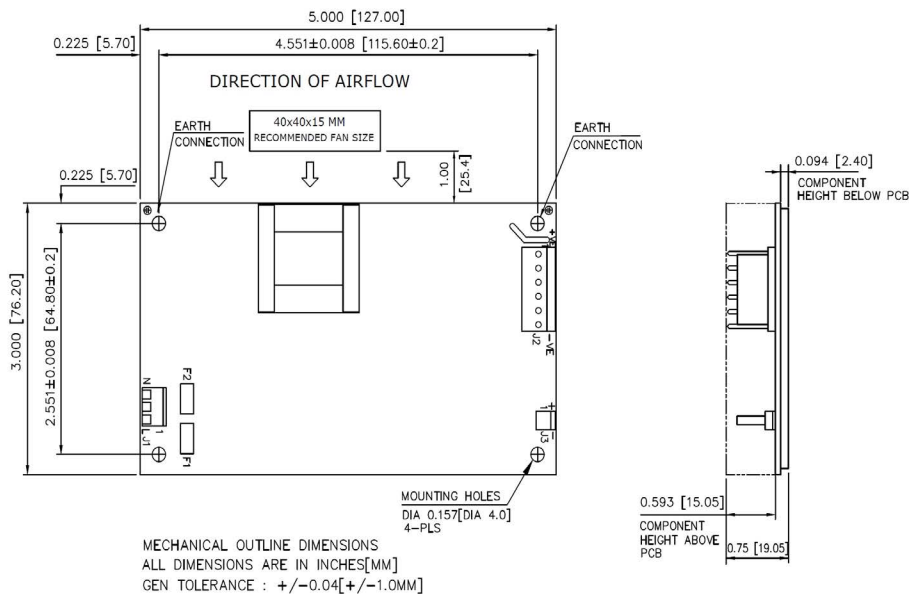

Notes: In case the PCB is mounted in a metal enclosure, using metal hardware ensure the following

1. Stand off, used to mount PCB has OD of 5.4 mm max.
2. Screws, used to fix PCB on stand off, have head dia of 6.0 mm max.
3. Washer, if used, to have dia of 6.5 mm max.

Mechanical Drawing

Option 3 (With PGPF)

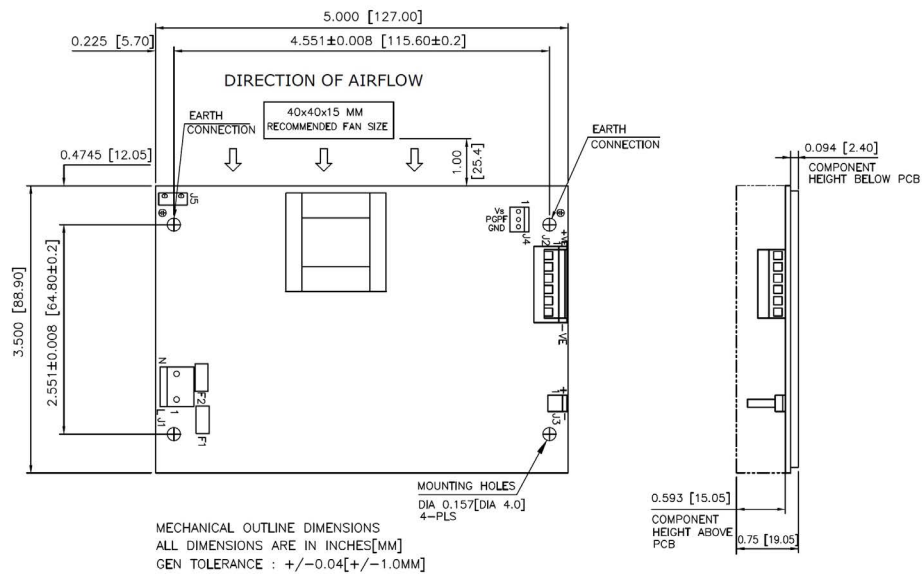

Notes: In case the PCB is mounted in a metal enclosure, using metal hardware ensure the following

1. Stand off, used to mount PCB has OD of 5.4 mm max.
2. Screws, used to fix PCB on stand off, have head dia of 6.0 mm max.
3. Washer, if used, to have dia of 6.5 mm max.

Mechanical Drawing

Option 4 (With PGPF)

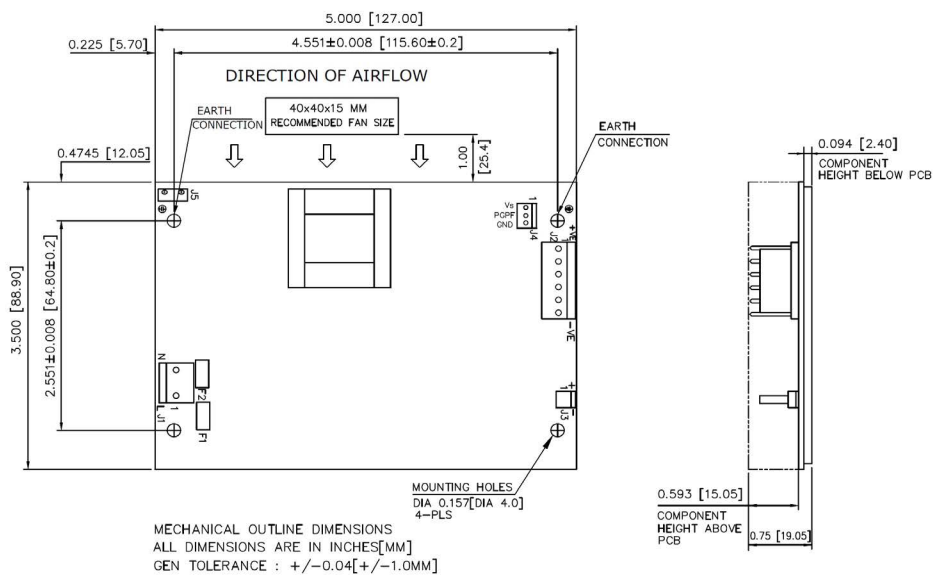

Notes: In case the PCB is mounted in a metal enclosure, using metal hardware ensure the following

1. Stand off, used to mount PCB has OD of 5.4 mm max.
2. Screws, used to fix PCB on stand off, have head dia of 6.0 mm max.
3. Washer, if used, to have dia of 6.5 mm max.