

STELLA-FRESNEL

~25° street beam for warehouse and outdoor lighting. Compatible with up to 30 mm LES size COBs. Variant with white frame.

TECHNICAL SPECIFICATIONS:

Dimensions	Ø 90.0 mm
Height	23 mm
Fastening	screw
Ingress protection classes	IP67
ROHS compliant	yes ⓘ



MATERIAL SPECIFICATIONS:

Component	Type	Material	Colour	Finish
STELLA-FRESNEL	Single lens	Silicone	clear	
STELLA-FRAME-WHT	Holder	PA66	white	





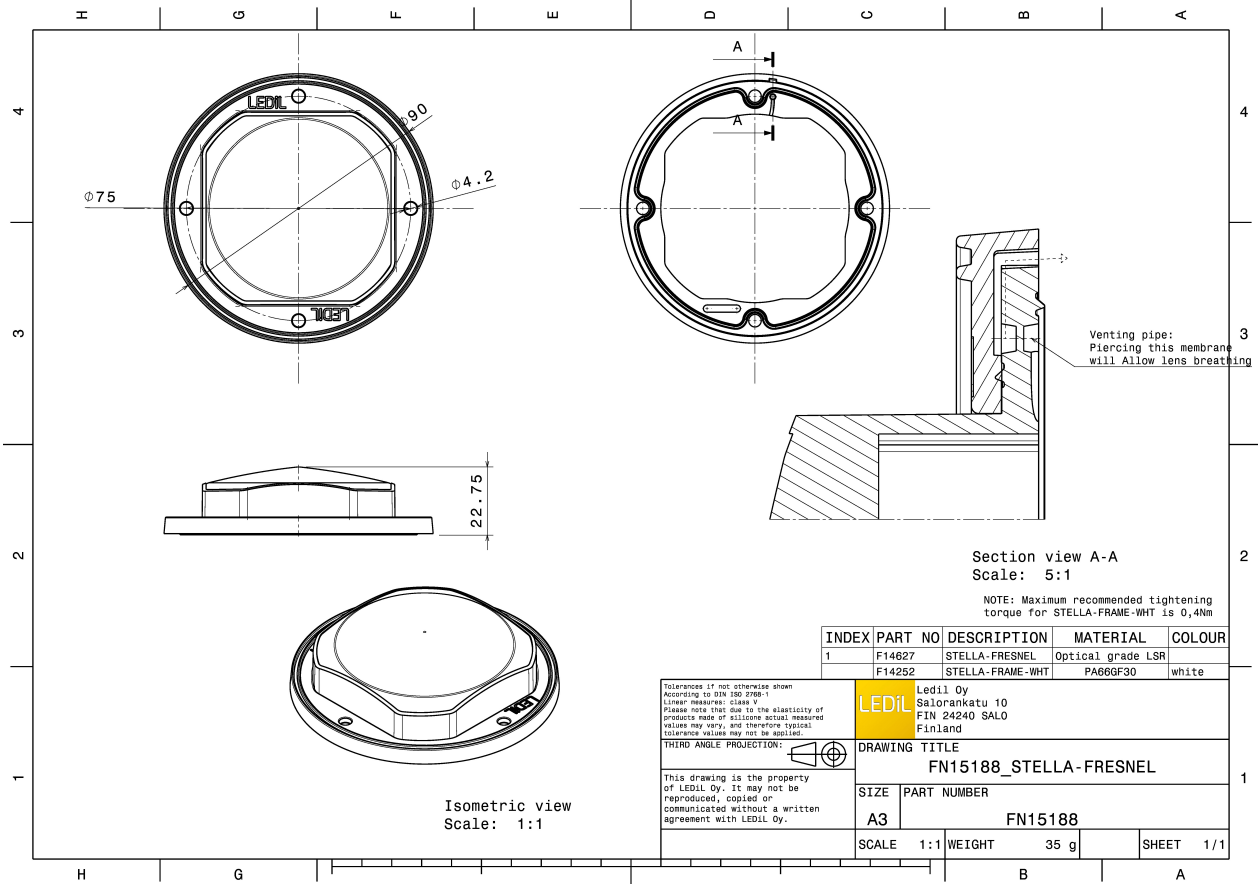

ORDERING INFORMATION:

Component	Type	Qty in box	MOQ	MPQ	Box weight (kg)
FN15188_STELLA-FRESNEL » Box size: 480 x 280 x 300 mm	Single lens	135	135	15	6.1

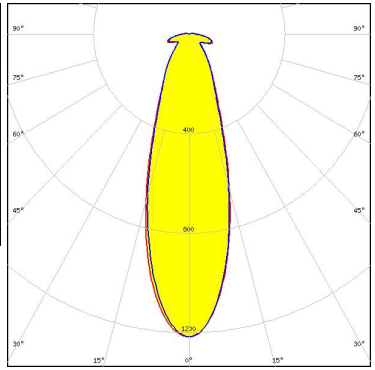

See also our general installation guide: www.ledil.com/installation_guide

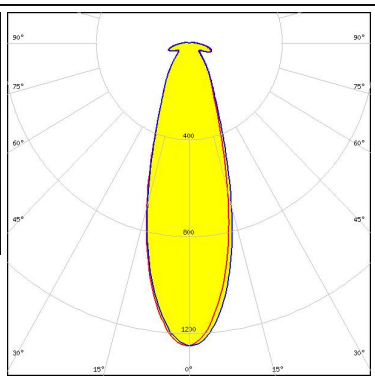
PHOTOMETRIC DATA (MEASURED):

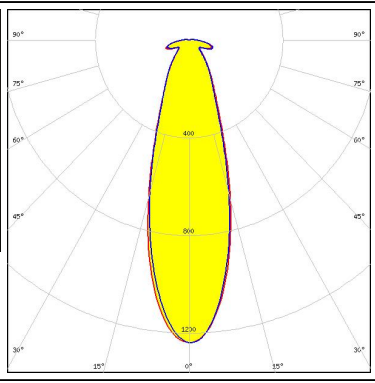
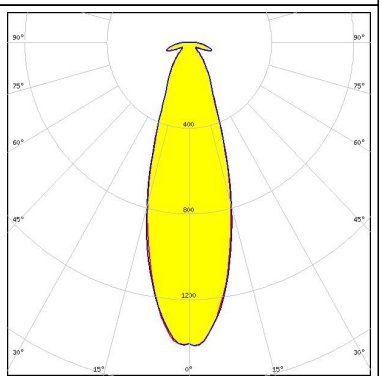
<p></p> <p>LED V18 Gen7 FWHM / FWTM 32.0° / 78.0° Efficiency 87 % Peak intensity 1.2 cd/lm LEDs/each optic 1 Light colour White Required components: Bender Wirth: 439 Typ L3</p>		
<p></p> <p>LED Vero SE 18 FWHM / FWTM 32.0° / 76.0° Efficiency 88 % Peak intensity 1.3 cd/lm LEDs/each optic 1 Light colour White Required components:</p>		
<p></p> <p>LED VERO18 FWHM / FWTM 32.0° / 76.0° Efficiency 88 % Peak intensity 1.2 cd/lm LEDs/each optic 1 Light colour White Required components:</p>		
<p>CITIZEN</p> <p>LED CLL04x/CLU04x FWHM / FWTM 36.0° / 99.0° Efficiency 86 % Peak intensity 1.1 cd/lm LEDs/each optic 1 Light colour White Required components:</p>		

PHOTOMETRIC DATA (MEASURED):

CREE

LED CXA/B 1816 & CXA/B 1820 & CXA 1850
 FWHM / FWTM 24.0° / 59.0°
 Efficiency 86 %
 Peak intensity 1.9 cd/lm
 LEDs/each optic 1
 Light colour White
 Required components:

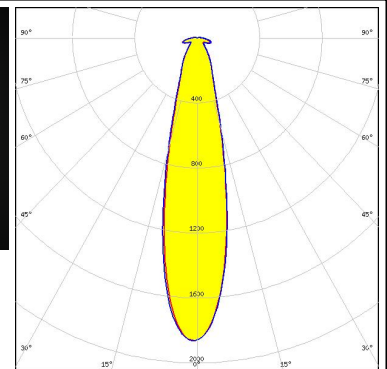
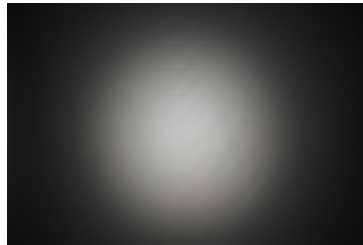

CREE

LED CXA/B 25xx
 FWHM / FWTM 32.0° / 77.0°
 Efficiency 87 %
 Peak intensity 1.3 cd/lm
 LEDs/each optic 1
 Light colour White
 Required components:
 Bender Wirth: 439 Typ L3

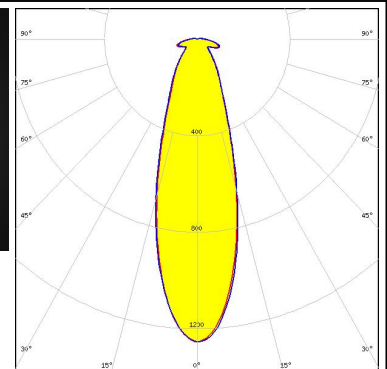
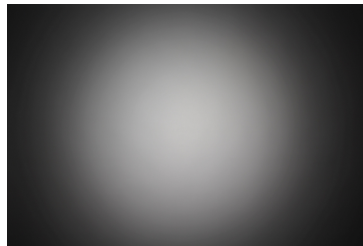

CREE



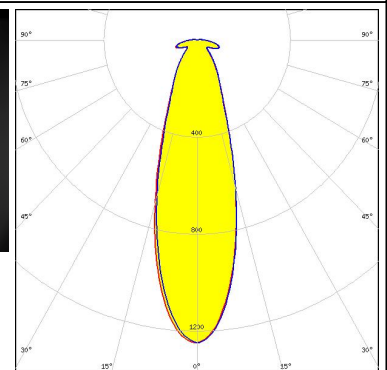



LED CXA/B 25xx
 FWHM / FWTM 31.0° / 75.0°
 Efficiency 86 %
 Peak intensity 1.2 cd/lm
 LEDs/each optic 1
 Light colour White
 Required components:

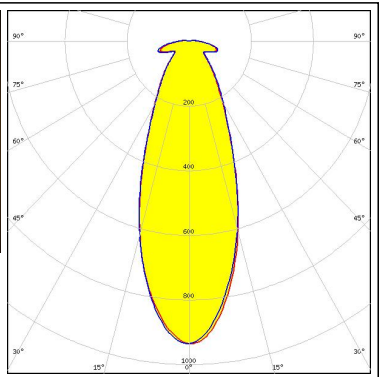

LUMILEDS

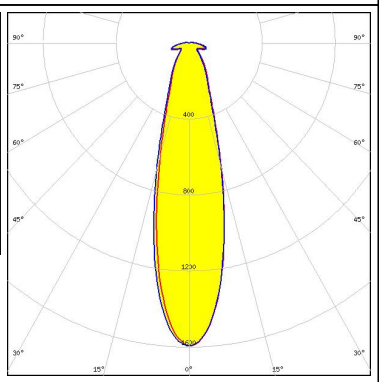
LED LUXEON CoB 1216/1812
 FWHM / FWTM 39.0° / 86.0°
 Efficiency 86 %
 Peak intensity 0.9 cd/lm
 LEDs/each optic 1
 Light colour White
 Required components:

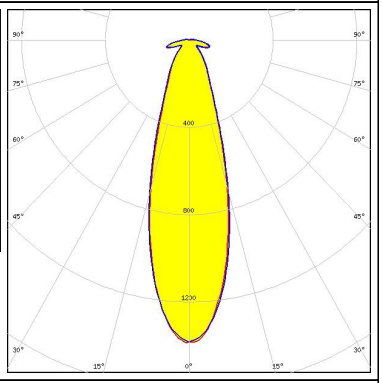
PHOTOMETRIC DATA (MEASURED):

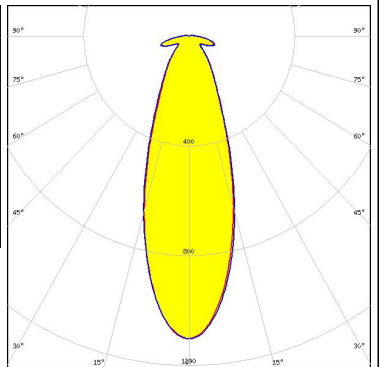
<p>LUMINUS</p> <p>LED CxM-22 (28x28)</p> <p>FWHM / FWTM 39.0° / 137.0°</p> <p>Efficiency 88 %</p> <p>Peak intensity 0.9 cd/m</p> <p>LEDs/each optic 1</p> <p>Light colour White</p> <p>Required components: Bender Wirth: 431 Typ L3</p>		
<p>NICHIA</p> <p>LED COB J-Type</p> <p>FWHM / FWTM 26.0° / 66.0°</p> <p>Efficiency 87 %</p> <p>Peak intensity 1.6 cd/m</p> <p>LEDs/each optic 1</p> <p>Light colour White</p> <p>Required components:</p>		
<p>PHILIPS</p> <p>LED Fortimo SLM L19 CoB</p> <p>FWHM / FWTM 31.0° / 71.0°</p> <p>Efficiency 87 %</p> <p>Peak intensity 1.4 cd/m</p> <p>LEDs/each optic 1</p> <p>Light colour White</p> <p>Required components: Bender Wirth: 431 Typ Z1</p>		
<p>PHILIPS</p> <p>LED Fortimo SLM L23 CoB</p> <p>FWHM / FWTM 35.0° / 114.0°</p> <p>Efficiency 87 %</p> <p>Peak intensity 1.1 cd/m</p> <p>LEDs/each optic 1</p> <p>Light colour White</p> <p>Required components: Bender Wirth: 431 Typ Z1</p>		

PHOTOMETRIC DATA (MEASURED):

SAMSUNG

LED LC016D / LC019D / LC026D / LC033D
 FWHM / FWTM 28.0° / 67.0°
 Efficiency 86 %
 Peak intensity 1.5 cd/m
 LEDs/each optic 1
 Light colour White
 Required components:

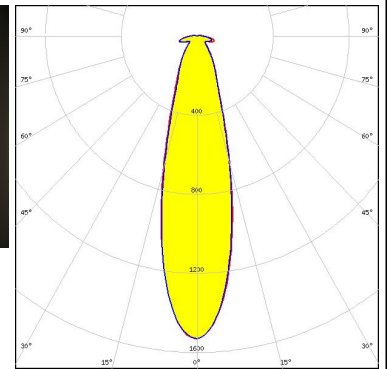
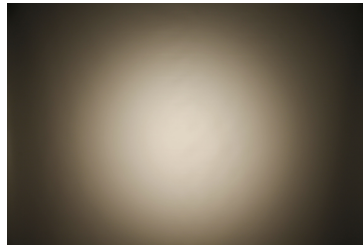

SAMSUNG

LED LC040D / LC060D / LC080D
 FWHM / FWTM 38.0° / 122.0°
 Efficiency 86 %
 Peak intensity 0.9 cd/m
 LEDs/each optic 1
 Light colour White
 Required components:

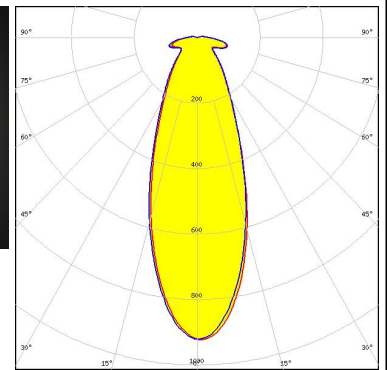
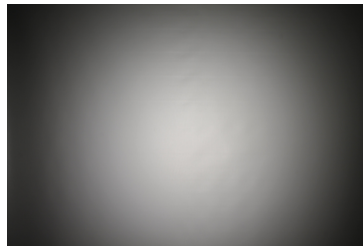



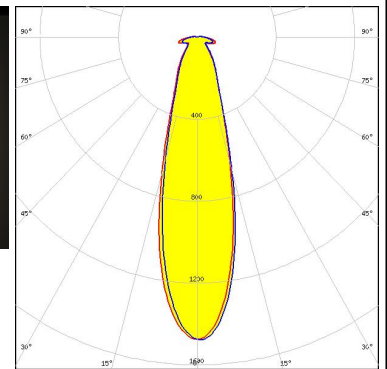
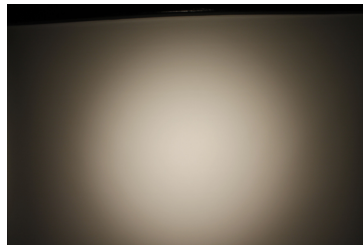

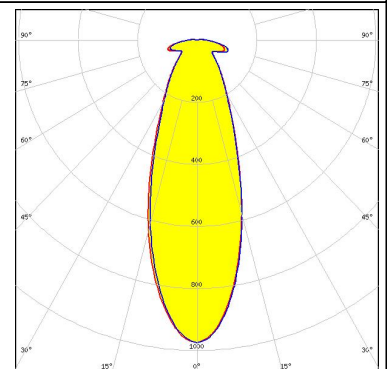

SEOUL SEMICONDUCTOR
 LED MJT COB LES 14.5
 FWHM / FWTM 28.0° / 68.0°
 Efficiency 86 %
 Peak intensity 1.5 cd/m
 LEDs/each optic 1
 Light colour White
 Required components:
 IDEAL: 50-2103CT

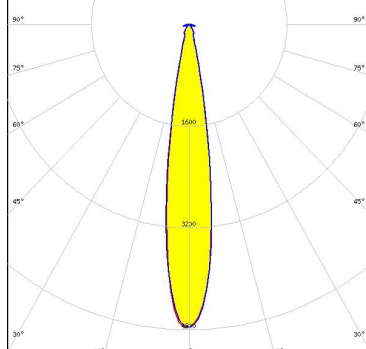

SEOUL SEMICONDUCTOR
 LED MJT COB LES 22
 FWHM / FWTM 36.0° / 120.0°
 Efficiency 87 %
 Peak intensity 1 cd/m
 LEDs/each optic 1
 Light colour White
 Required components:
 IDEAL: 50-2204CT

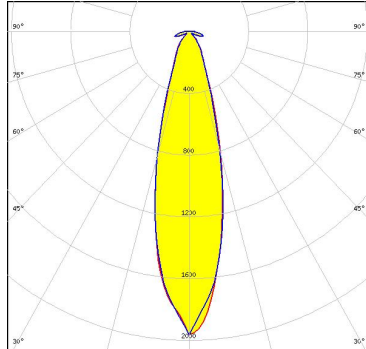

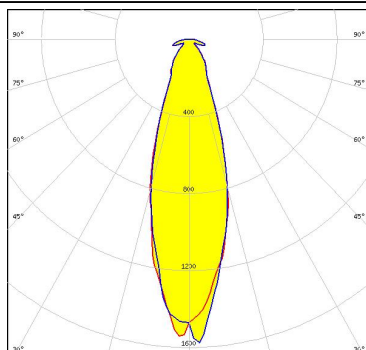
PHOTOMETRIC DATA (SIMULATED):

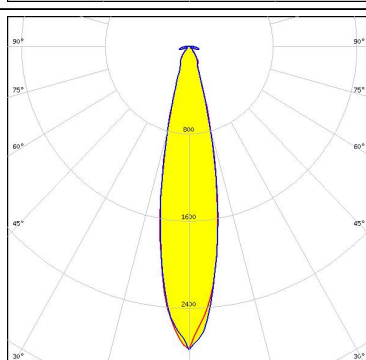
<p> bridgelux.</p> <p>LED V10 Gen7 FWHM / FWTM 17.0° / 31.0° Efficiency 85 % Peak intensity 4.8 cd/lm LEDs/each optic 1 Light colour White Required components: Bender Wirth: 486 Typ L1</p>	
<p> bridgelux.</p> <p>LED V18 Gen7 FWHM / FWTM 26.0° / 57.0° Efficiency 85 % Peak intensity 2 cd/lm LEDs/each optic 1 Light colour White Required components: BJB: 47.319.2350</p>	
<p> bridgelux.</p> <p>LED V22 Gen7 FWHM / FWTM 30.0° / 70.0° Efficiency 84 % Peak intensity 1.6 cd/lm LEDs/each optic 1 Light colour White Required components: IDEAL: 50-2204CT</p>	
<p> LUMILEDS</p> <p>LED LUXEON CoB 1208 FWHM / FWTM 22.0° / 43.0° Efficiency 85 % Peak intensity 2.8 cd/lm LEDs/each optic 1 Light colour White Required components:</p>	

GENERAL INFORMATION:

NOTE: The typical beam angle will be changed by different color, chip size and chip position tolerance. The typical total beam angle is the full angle measured where the luminous intensity is half of the peak value.

Due to use of high power COB's with this product, special attention to proper thermal design is highly recommended. LEDiL has no liability for direct, indirect or consecutive damages arising from the LEDiL products being used outside of the recommended temperature range.

MATERIALS:

As part of our continuous research and improvement processes, and to ensure the best possible quality and availability of our products, LEDiL reserves the right to change material grades without notice.

PRODUCT DATA USER AGREEMENT AND DISCLAIMER:

The measured data in the provided downloadable LEDiL Product Datasheets and Mechanical 2D-Drawings is rounded and provided as reference for planning. LEDiL Oy's optical specifications have been verified by conducting performance testing of the products in accordance with the company's quality system. The reported data are averaged results of multiple measurements with typical variation. LEDiL Oy reserves the right to without prior notification make changes and improvements to its products.

LEDiL Oy assumes neither warranty, nor guarantee nor any other liability of any kind for the contents and correctness of the provided data. The provided data has been generated with highest diligence but the provided data may in reality not represent the complete possible variation range of all intrinsic parameters. Therefore, in certain cases a deviation from the provided data could occur.

LEDiL Oy reserves the right to undertake technical changes of its products without further notification which could lead to changes in the provided data. LEDiL Oy assumes no liability of any kind for the possible deviation from any provided data or any other damage resulting from the usage of the provided data.

The user agrees to this disclaimer and user agreement with the download or usage of the provided files.

LEDiL Oy

Joensuunkatu 13
FI-24240 SALO
Finland

LEDiL Inc.

228 West Page Street
Suite D
Sycamore IL 60178
USA

Ledil Optics Technology (Shenzhen) Co., Ltd.

405 , Block B
Casic Motor Building
Shenzhen 518057
P.R.CHINA

Local sales and technical support

[www.ledil.com/
where_to_buy](http://www.ledil.com/where_to_buy)

Shipping locations

Salo, Finland
Hong Kong, China

Distribution Partners

[www.ledil.com/
where_to_buy](http://www.ledil.com/where_to_buy)