

SERPAC CA8B4 (4 button option)

Electronic Enclosures

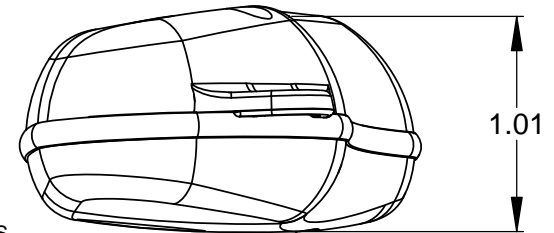
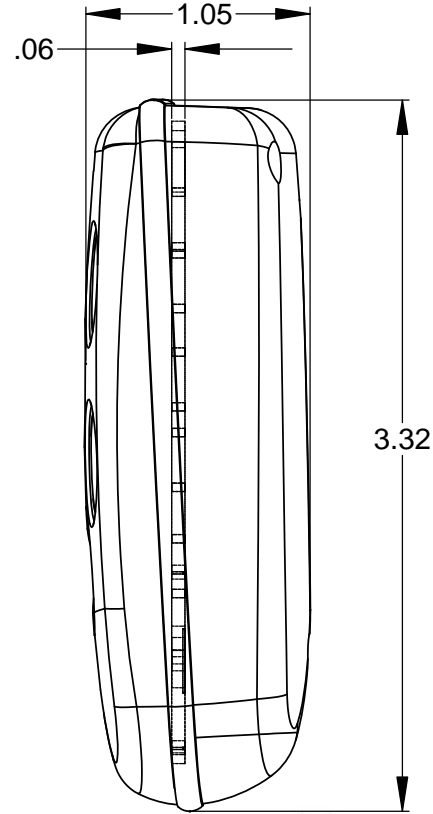
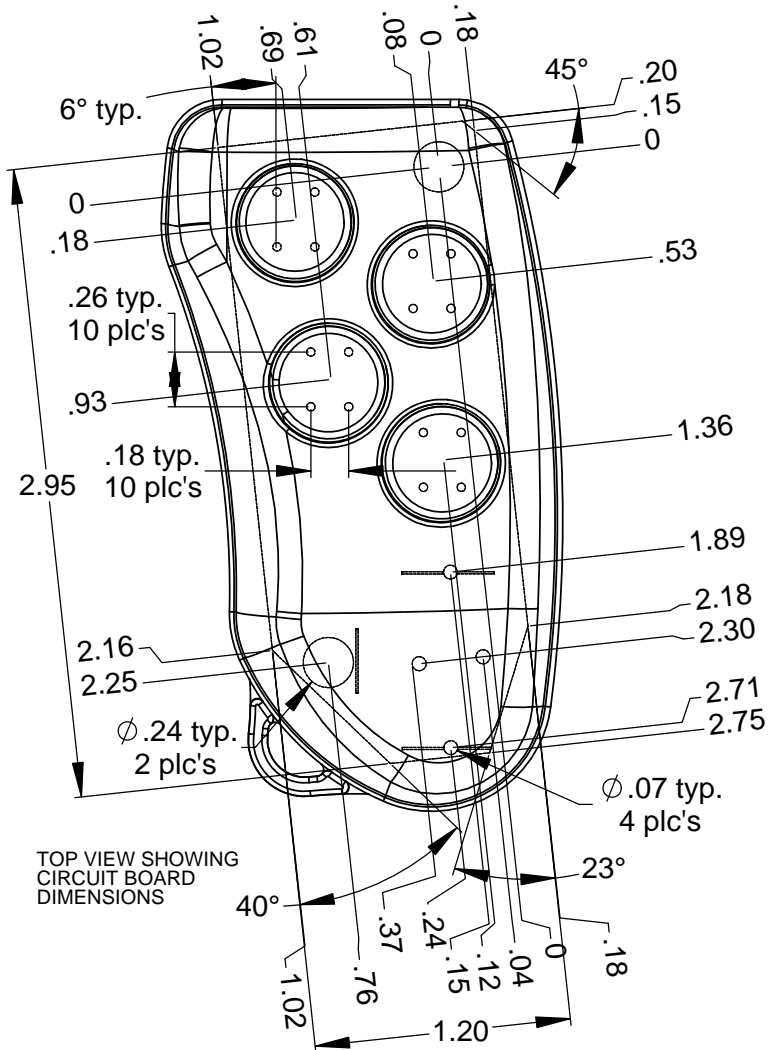

NOTES:

- 1) Serpac Provides the following components:
Top, Bottom, Button Membrane, 9mm keyring and (2) #2 Screws.
All components are shipped unassembled.
- 2) The switches characteristics recommended for this enclosure are:
- 4.3 mm in height from mounting surface to top of push plate.
- Operating force recommended is 1.6 N or more.
- 3) For battery contacts use:
- for Coin battery Keystone 3003 positive and 2990 negative.

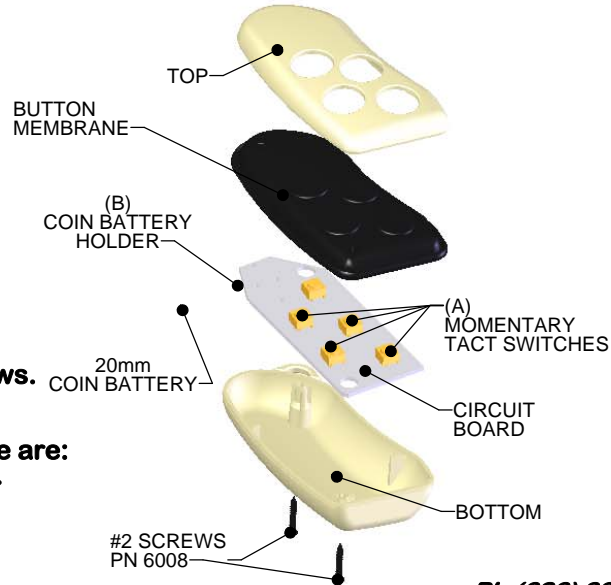

ALL DIMENSIONS ARE $\pm .010''$ 6/25/2013
2009 Wright Ave, La Verne, CA 91750
Ph: (626) 331-0517 Fx: (626) 331-8584 www.serpac.com