

MATERIALS AND FINISH:

SHELL: STEEL MATERIAL, NICKEL FINISH
 INSULATOR: PA9T = 260°C, UL 94V-0 RATED, BLACK
 CONTACT MATERIAL: BRASS
 CONTACT FINISH: SEE PLATING PART NUMBER KEY BELOW
 SEAL MATERIAL: F08 FLEXIBLE ADHESIVE

ELECTRICAL:

CONTACT CURRENT RATING: 5 AMPS
 CONTACT RESISTANCE: 10 mOHMS Max.
 DIELECTRIC WITHSTANDING VOLTAGE: 1,000 VAC Min.
 INSULATION RESISTANCE: 5 GOHMS Min.
 TEMPERATURE RATING: -55° ~ +125° C

DIMENSIONS (in.)					
No. OF PINS	A	B	C	D	Insulator Material
15	0.665	0.984	1.213	0.090	PA9T
26	0.994	1.311	1.543	0.090	PA9T
44	1.533	1.852	2.089	0.090	PA9T
62	2.181	2.500	2.732	0.095	PA6T

DIMENSIONS (mm)					
No. OF PINS	A	B	C	D	Insulator Material
15	16.90	25.00	30.80	2.29	PA9T
26	25.25	33.30	39.20	2.29	PA9T
44	38.95	47.05	53.05	2.29	PA9T
62	55.40	63.50	69.40	2.41	PA6T

MEETS IP67 STANDARDS

(SEE PAGE 3 FOR SEALING DETAILS)

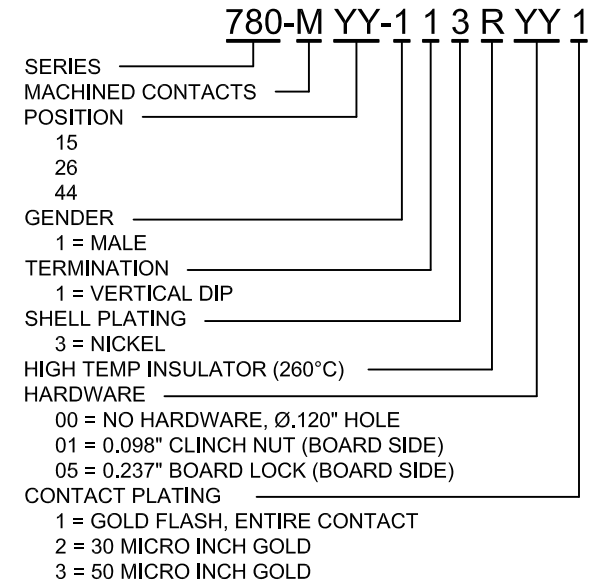

RoHS COMPLIANT

UNITS = INCHES [MM] **DO NOT SCALE FROM DRAWING**



THESE DRAWINGS AND SPECIFICATIONS ARE THE PROPERTY OF NorComp AND SHALL NOT BE REPRODUCED, COPIED OR USED AS THE BASIS FOR THE MANUFACTURE OR SALE OF APPARATUS WITHOUT WRITTEN PERMISSION.

DRAWN:

J. KADEL

DATE:

08/03/2018

NorComp

SCALE: NTS

SHEET 1 OF 4

REV 14

DWG NO.

780-MYY-113RYY1

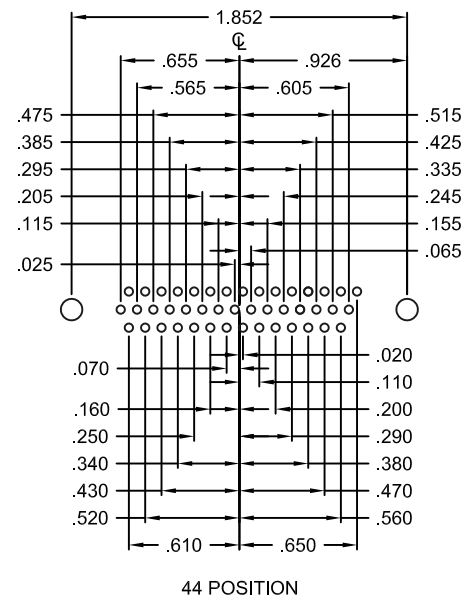
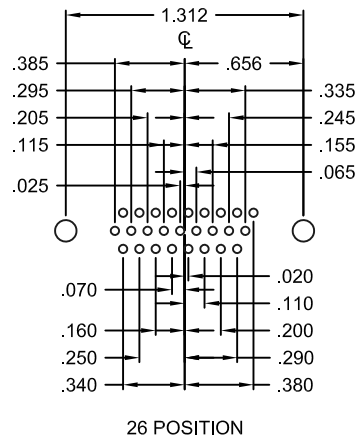
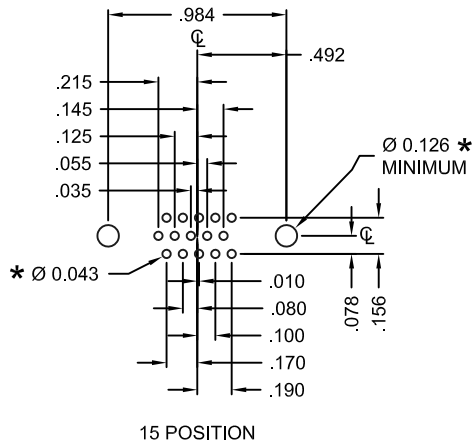

HOLE PATTERN SHOWN
ARE FOR MALE

UNITS = inch

* TYP.
SUGGESTED SIZE
MAY NOT BE SUITABLE FOR ALL APPLICATIONS

RoHS COMPLIANT

DO NOT SCALE FROM DRAWING



THESE DRAWINGS AND SPECIFICATIONS ARE THE PROPERTY OF NorComp AND SHALL NOT BE REPRODUCED, COPIED OR USED AS THE BASIS FOR THE MANUFACTURE OR SALE OF APPARATUS WITHOUT WRITTEN PERMISSION.

DRAWN:

J. KADEL

DATE:

08/03/2018

NorComp

SCALE:
NTS

SHEET OF
2 4

REV
14

DWG NO.

780-MYY-113RYY1

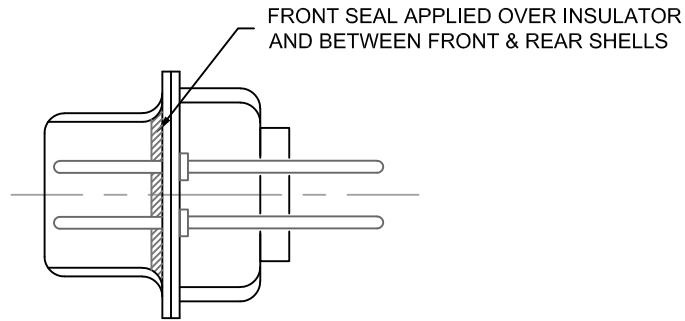
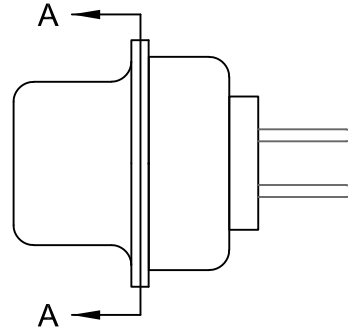

DETAIL A-A

RoHS COMPLIANT

DO NOT SCALE FROM DRAWING



THESE DRAWINGS AND SPECIFICATIONS ARE THE PROPERTY OF NorComp AND SHALL NOT BE REPRODUCED, COPIED OR USED AS THE BASIS FOR THE MANUFACTURE OR SALE OF APPARATUS WITHOUT WRITTEN PERMISSION.

DRAWN:

J. KADEL

DATE:

08/03/2018

NorComp

SCALE:
NTS

SHEET OF
3 4

REV
14

DWG NO.

780-MYY-113RYY1

ALL CLINCH-NUTS ARE 4-40 INTERNAL THREADS

01X 0.098" (BOARD SIDE)

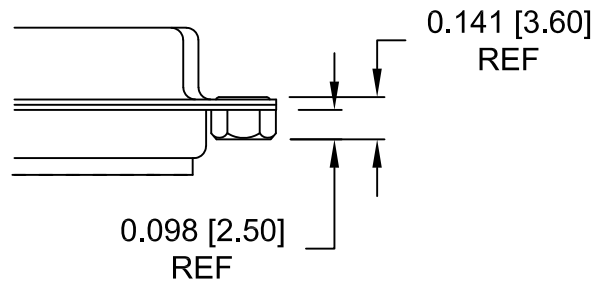

05X 0.237" (BOARD SIDE)

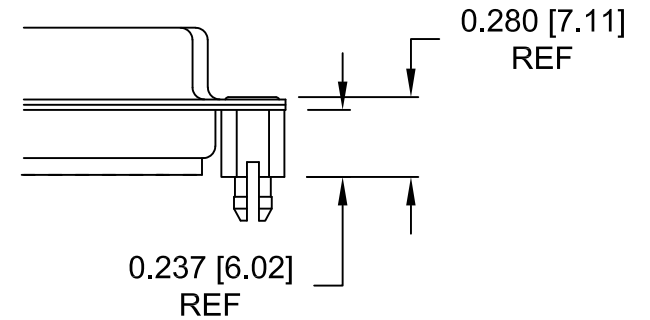

RoHS COMPLIANT

UNITS = INCHES [MM] DO NOT SCALE FROM DRAWING



THESE DRAWINGS AND SPECIFICATIONS ARE THE PROPERTY OF NorComp AND SHALL NOT BE REPRODUCED, COPIED OR USED AS THE BASIS FOR THE MANUFACTURE OR SALE OF APPARATUS WITHOUT WRITTEN PERMISSION.

DRAWN:

J. KADEL

DATE:

08/03/2018

NorComp

SCALE:
NTS

SHEET OF
4 4

REV
14

DWG NO.

780-MYY-113RYY1