

Use Conditions: $1.2V \leq V_{CCA} \leq 3.6$ $1.65 \leq V_{CCB} \leq 5.5V$ $V_{CCA} < V_{CCB}$

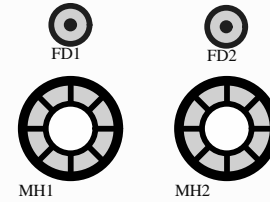

Title: 8-Bit Level Translator	Code: DFR0844
Drawn: HDJ-CD	Revision: V1.0
Page: 1 of 1	Date: 2021-03-03
	Time: 10:05:55

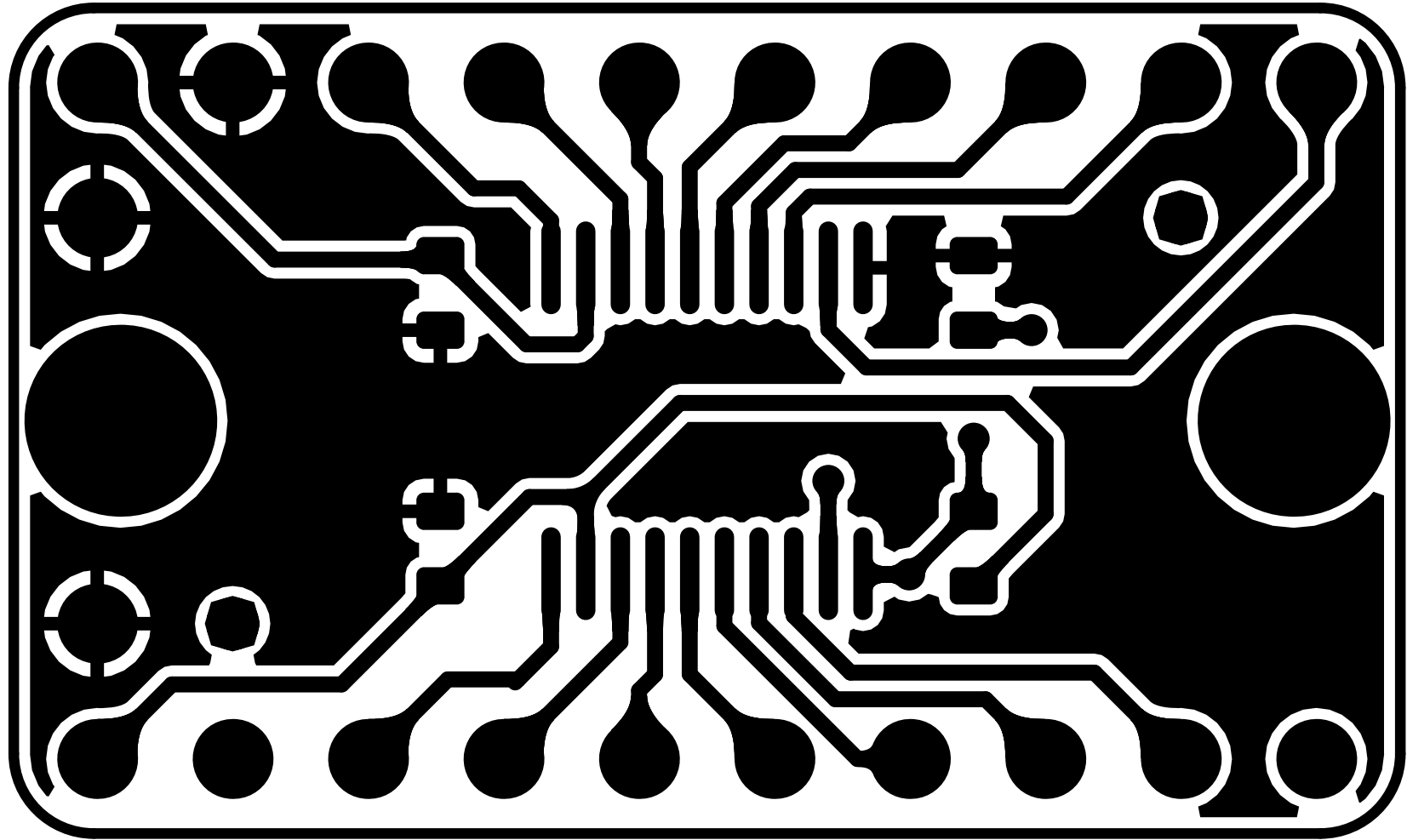

PCB Information	Name:DFR0844[V1.0]	Thickness: 1.0mm
Engineer: HDJ	Top SolderMask: Black	Bottom SolderMask: Black
Date: 20210303	Top Silkscreen: White	Bottom Silkscreen: White

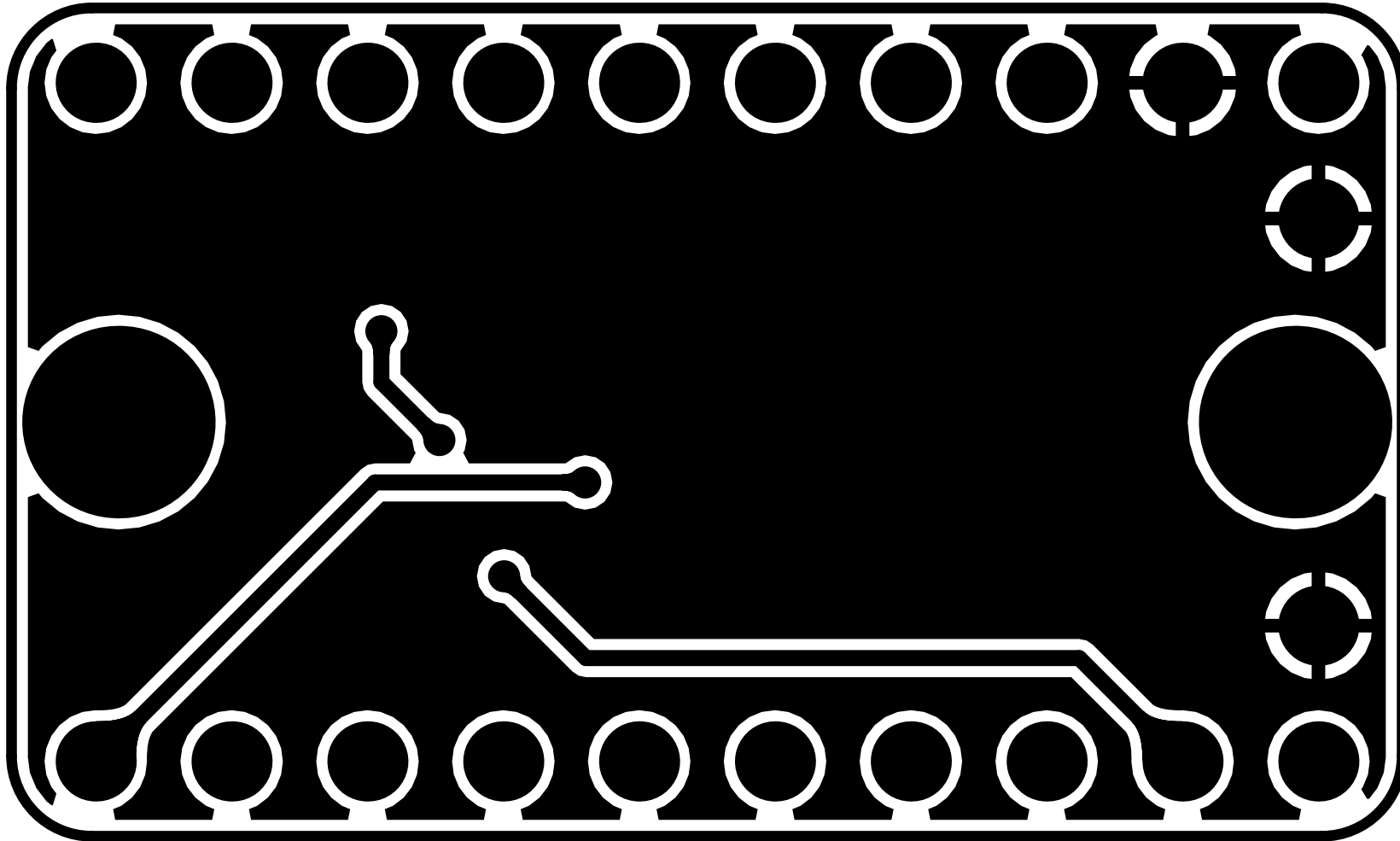

PCB Information	Name:DFR0844[V1.0]	Thickness: 1.0mm
Engineer: HDJ	Top SolderMask: Black	Bottom SolderMask: Black
Date: 20210303	Top Silkscreen: White	Bottom Silkscreen: White

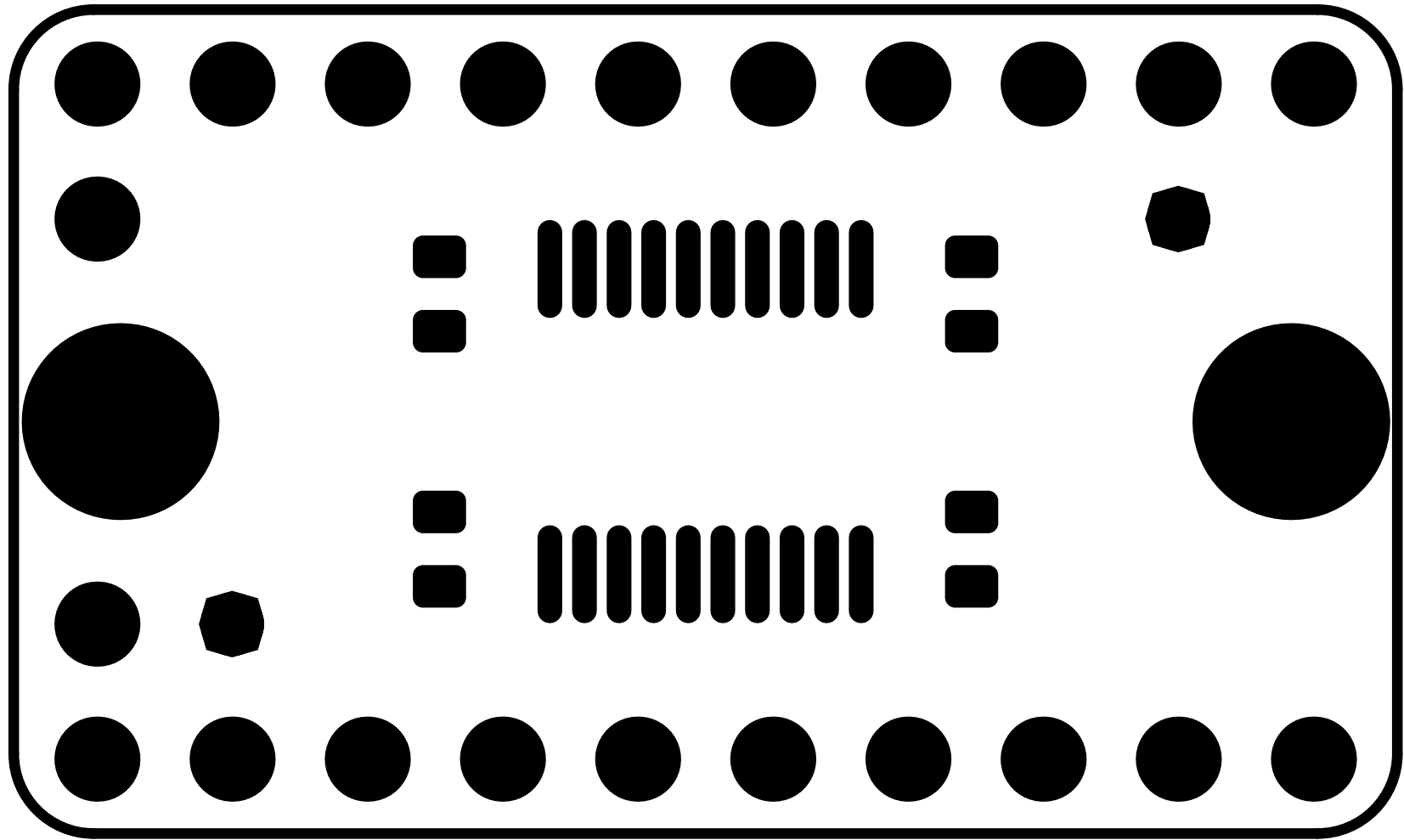

PCB Information	Name:DFR0844[V1.0]	Thickness: 1.0mm
Engineer: HDJ	Top SolderMask: Black	Bottom SolderMask: Black
Date: 20210303	Top Silkscreen: White	Bottom Silkscreen: White

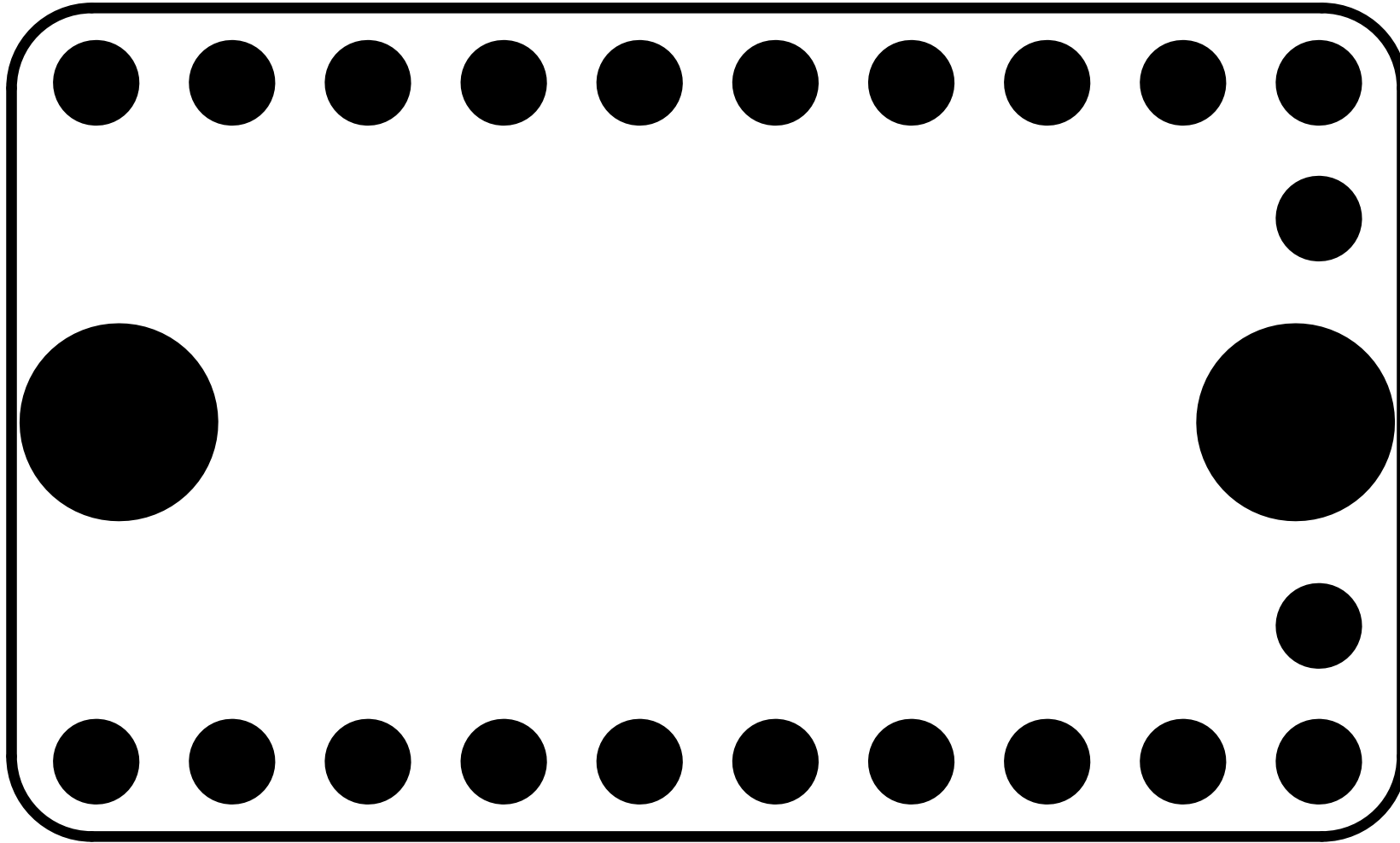

PCB Information	Name:DFR0844[V1.0]	Thickness: 1.0mm
Engineer: HDJ	Top SolderMask: Black	Bottom SolderMask: Black
Date: 20210303	Top Silkscreen: White	Bottom Silkscreen: White

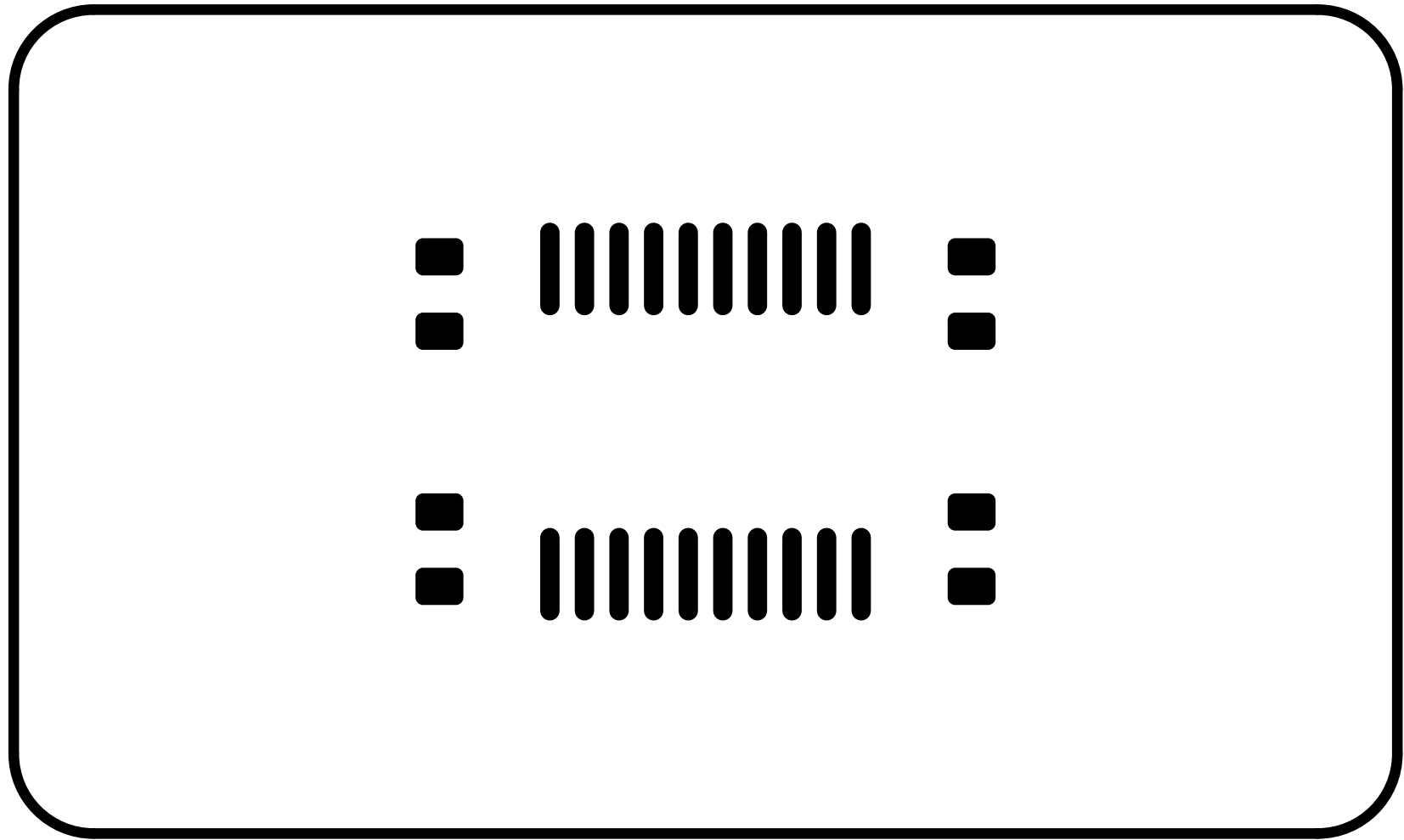

PCB Information	Name:DFR0844[V1.0]	Thickness: 1.0mm
Engineer: HDJ	Top SolderMask: Black	Bottom SolderMask: Black
Date: 20210303	Top Silkscreen: White	Bottom Silkscreen: White



PCB Information	Name:DFR0844[V1.0]	Thickness: 1.0mm
Engineer: HDJ	Top SolderMask: Black	Bottom SolderMask: Black
Date: 20210303	Top Silkscreen: White	Bottom Silkscreen: White

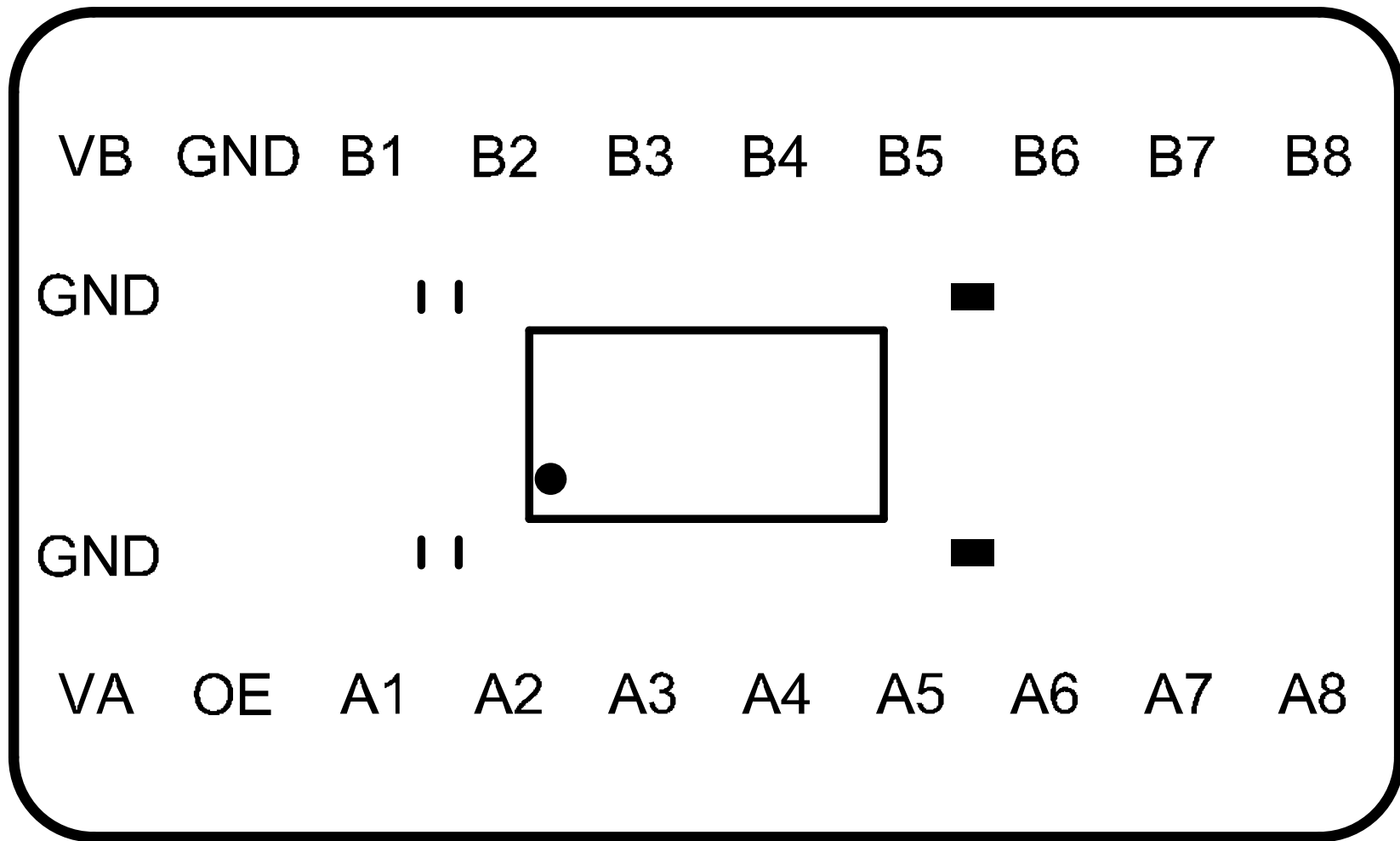

PCB Information	Name:DFR0844[V1.0]	Thickness: 1.0mm
Engineer: HDJ	Top SolderMask: Black	Bottom SolderMask: Black
Date: 20210303	Top Silkscreen: White	Bottom Silkscreen: White

B8 B7 B6 B5 B4 B3 B2 B1 GND VB

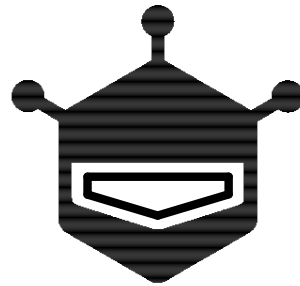

GND

8-Bit Level Translator V1.0

GND

A8 A7 A6 A5 A4 A3 A2 A1 OE VA

PCB Information	Name:DFR0844[V1.0]	Thickness: 1.0mm
Engineer: HDJ	Top SolderMask: Black	Bottom SolderMask: Black
Date: 20210303	Top Silkscreen: White	Bottom Silkscreen: White

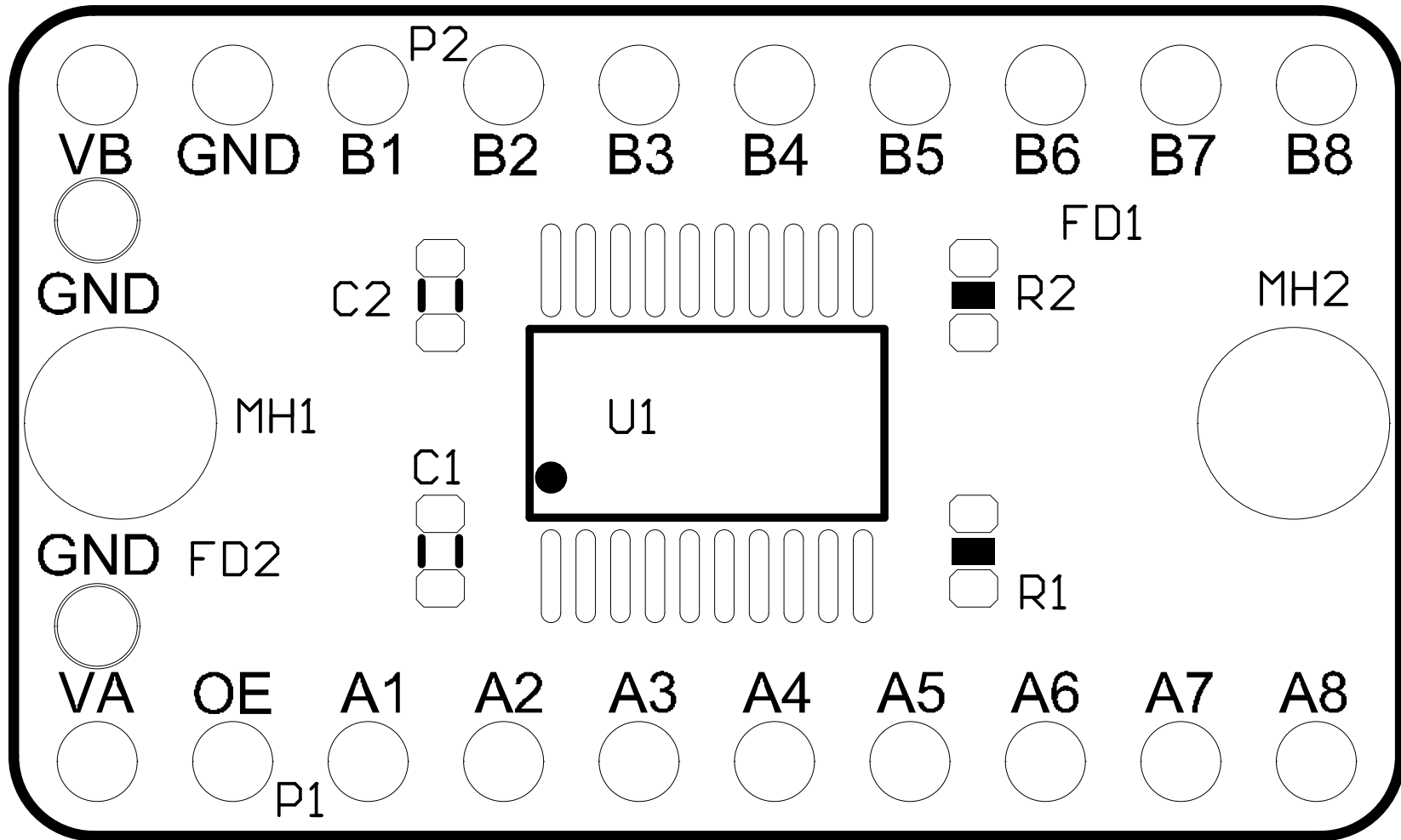

PCB Information	Name:DFR0844[V1.0]	Thickness: 1.0mm
Engineer: HDJ	Top SolderMask: Black	Bottom SolderMask: Black
Date: 20210303	Top Silkscreen: White	Bottom Silkscreen: White

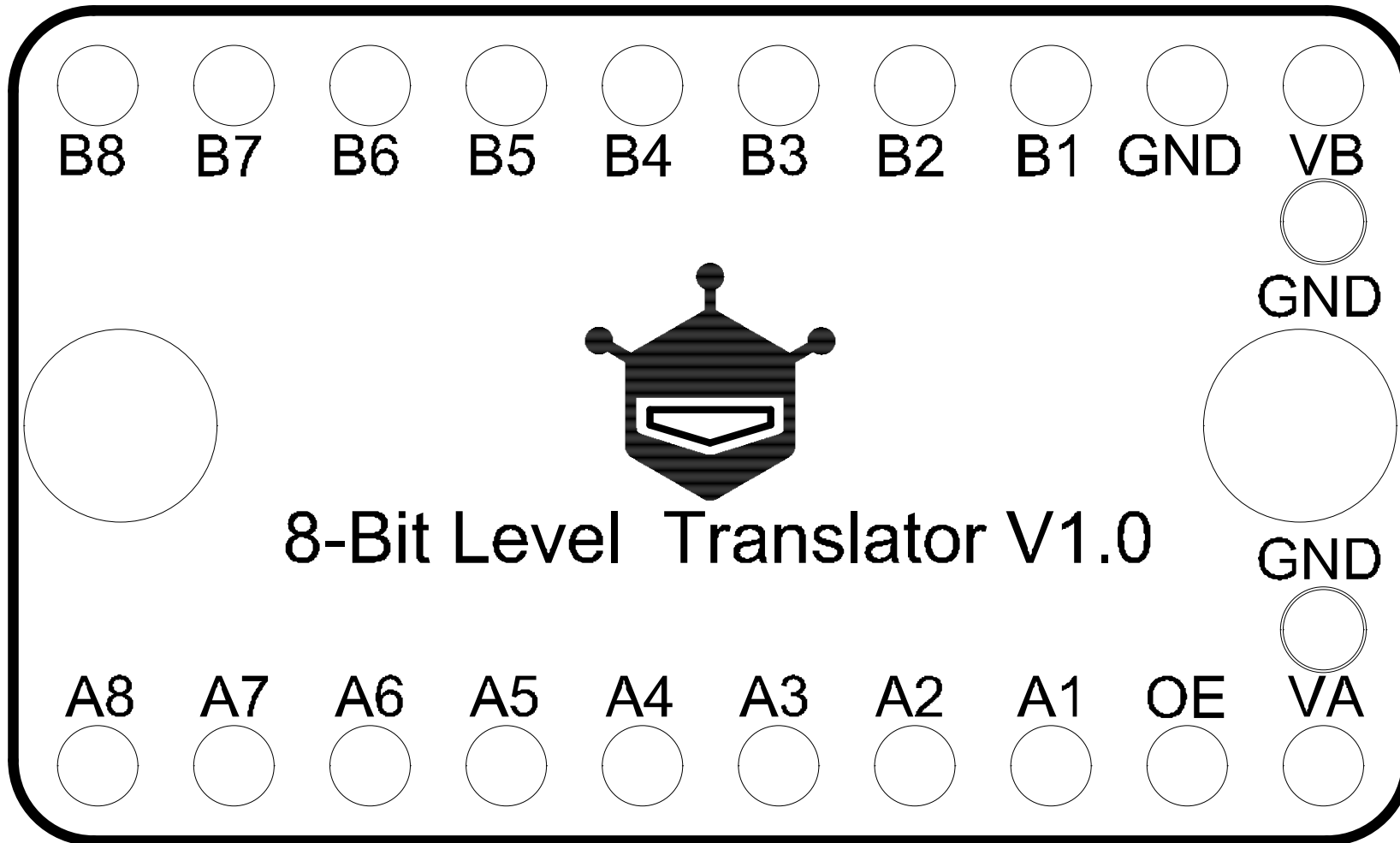

PCB Information	Name:DFR0844[V1.0]	Thickness: 1.0mm
Engineer: HDJ	Top SolderMask: Black	Bottom SolderMask: Black
Date: 20210303	Top Silkscreen: White	Bottom Silkscreen: White

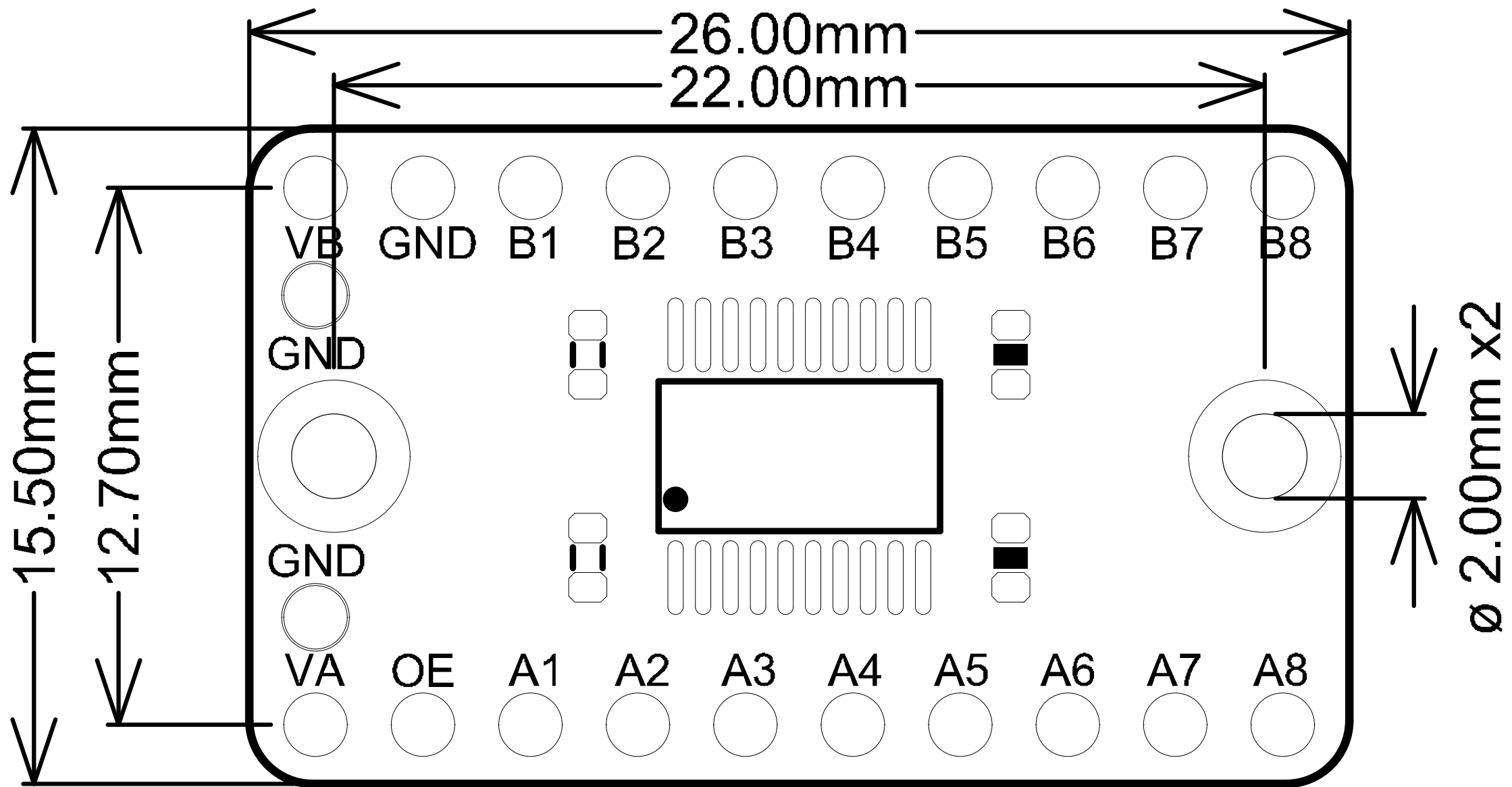

PCB Information	Name:DFR0844[V1.0]	Thickness:1.0mm
Engineer: HDJ	Top SolderMask: Black	Bottom SolderMask: Black
Date: 20210303	Top Silkscreen: White	Bottom Silkscreen: White

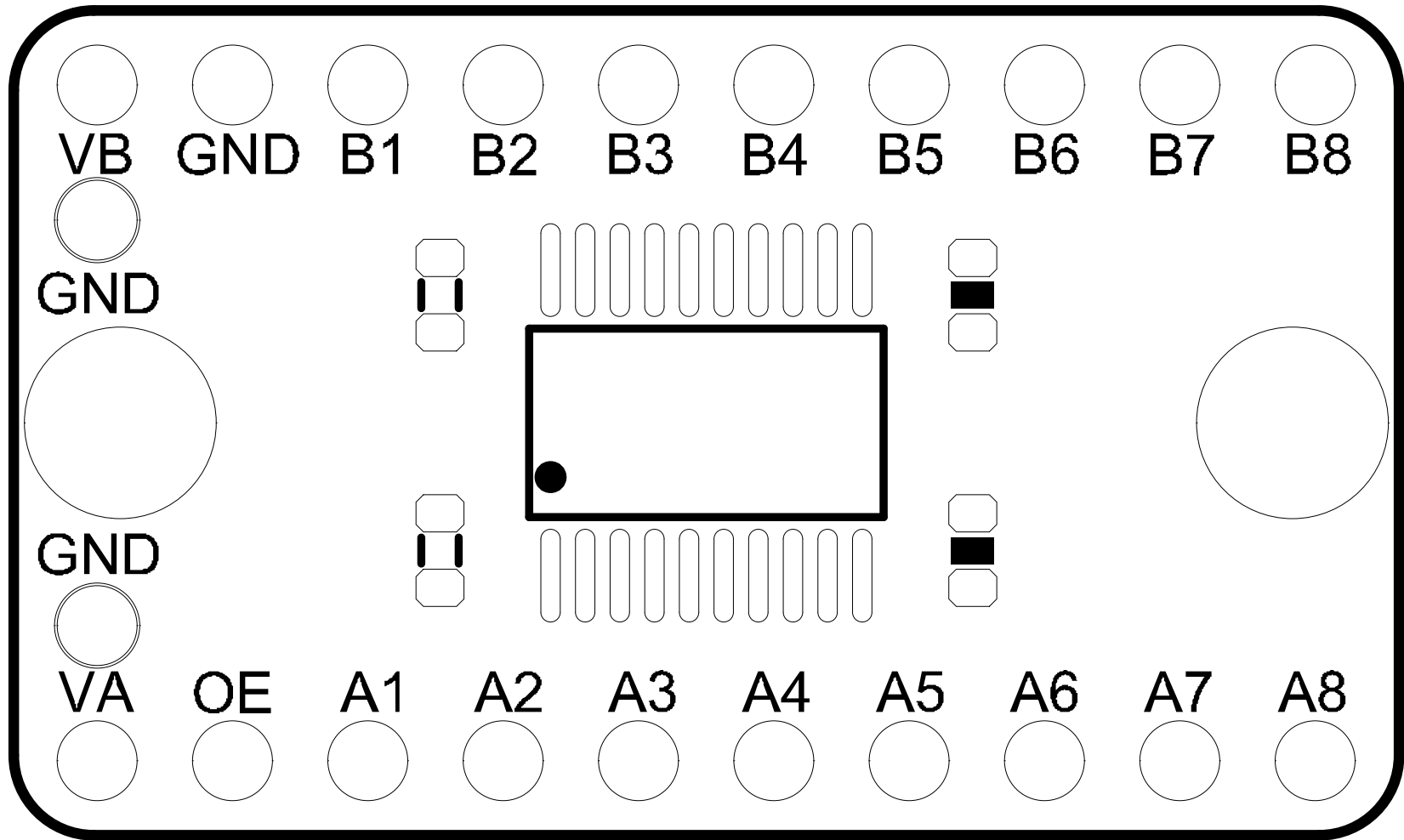

PCB Information	Name:DFR0844[V1.0]	Thickness: 1.0mm
Engineer: HDJ	Top SolderMask: Black	Bottom SolderMask: Black
Date: 20210303	Top Silkscreen: White	Bottom Silkscreen: White

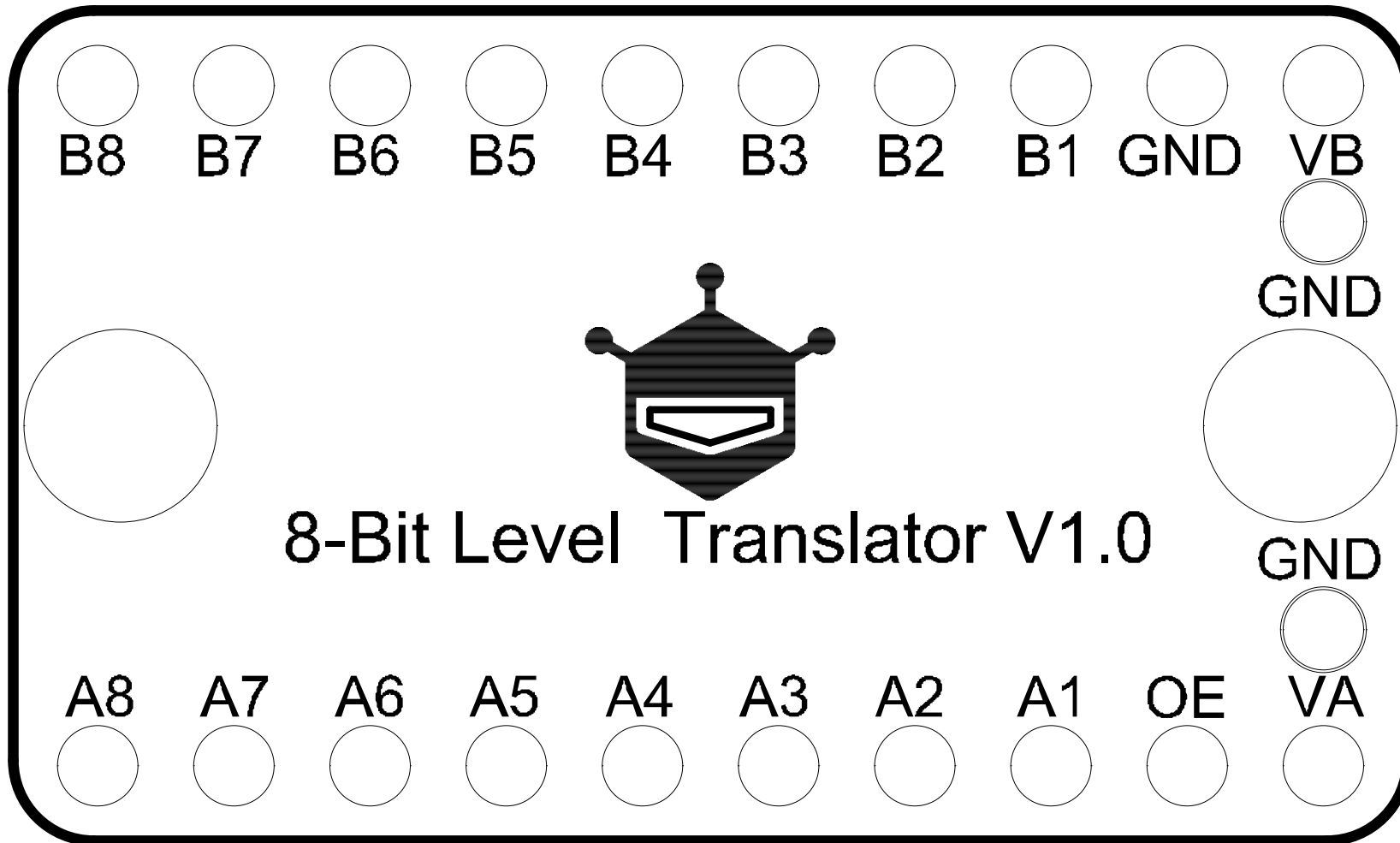

PCB Information	Name:DFR0844[V1.0]	Thickness: 1.0mm
Engineer: HDJ	Top SolderMask: Black	Bottom SolderMask: Black
Date: 20210303	Top Silkscreen: White	Bottom Silkscreen: White