

Data sheet | Item number: 770-204

Socket; 4-pole; Cod. A; 4,00 mm<sup>2</sup>; black

[www.wago.com/770-204](http://www.wago.com/770-204)

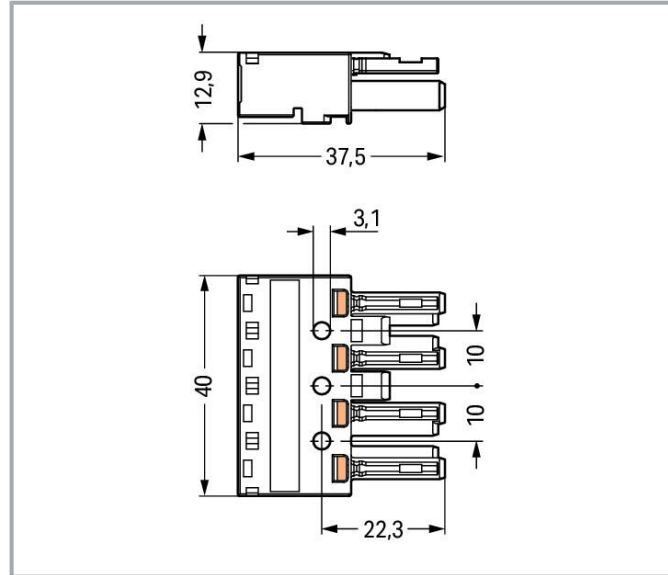
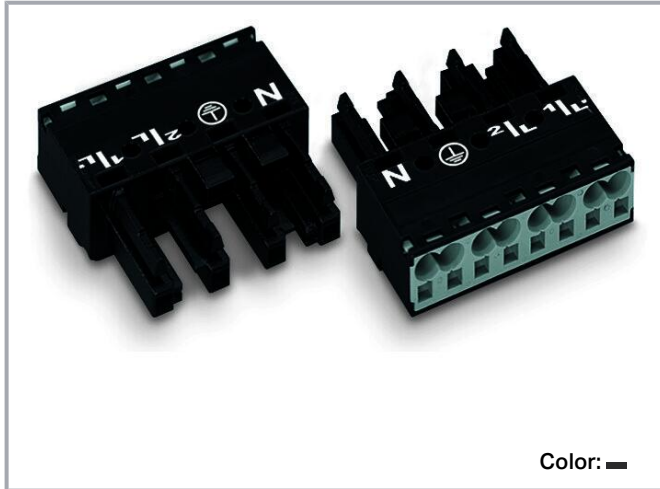

## Item description

### Female connector/socket WINSTA® MIDI with protection type IP20

The WINSTA® MIDI female connector/socket A coding provides the foundation for installation of fine-stranded and solid conductors. The pluggable installation connectors with spring pressure connection technology function without screw connections. They allow resource-efficient, error-free installation in a large number of applications. The color coding and mechanical coding of the pluggable installation connector ensure error-free installation of the individual components – including protection against mismatching. The pluggable installation connector offers touch-proof protection with live components in accordance with protection type IP20 (When mated and secured with a strain relief housing: IP2xC (These compact connectors are not designed for use in open, easily accessible areas!)). Thanks to the color coding and mechanical A coding of WINSTA® MIDI pluggable installation connectors, you can clearly distinguish different circuits. This pluggable installation connector can be used for electrical currents up to 25 A. Thus the product is ideally suitable for high power loads. Our WINSTA® MIDI product line guarantees flexibility for the electrical installation. With its Push-in CAGE CLAMP® spring pressure connection technology, it guarantees error-free, time-saving installation and offers flexibility and customization for meeting an enormous variety of installation requirements.

### Push-in CAGE CLAMP® spring pressure connection technology – pluggable installation instead of laborious screw connections!

Subject to changes. Please also observe the further product documentation!

WAGO GmbH & Co. KG  
Hansastr. 27  
32423 Minden  
Phone: +49571 887-0 | Fax: +49571 887-169  
Email: [info.de@wago.com](mailto:info.de@wago.com) | Web: [www.wago.com](http://www.wago.com)

Do you have any questions about our products?  
We are always happy to take your call at +49 (571) 887-44222.



WINSTA® is the pluggable connection system that is optimally tailored to the strict requirements of electrical installation. It offers error-free installation of cables and components, quickly and reliably. Now you can also reduce installation expenses without compromising quality and safety: The WINSTA® MIDI pluggable installation connector with protection type IP20 reduces the need for servicing and prevents unnecessary downtime.

- protection against mismatching eliminates errors
- pre-assembled versions
- with A coding for use in a large number of general mains applications
- ready for immediate use
- convenient installation and commissioning

## Data

### Electrical data

#### Ratings per IEC/EN

Ratings per	IEC/EN 60664-1
Nominal voltage (III/3)	400 V
Rated impulse voltage (III/3)	6 kV
Rated current	25 A
Legend (ratings)	(III / 3) ≙ Overvoltage category III / Pollution degree 3

#### Ratings per UL 1977

Note for the US market	Some versions may also be used for current interruption in accordance with the UL certificate in select applications with currents below 16 A and voltages up to 600 V. For further information, please contact your local sales office.
Rated voltage (UL 1977)	600 V
Rated current UL 1977	23 A

## General

Note on contact resistance	approx. 1 mΩ of contact resistance approx. 0.25 mΩ contact transition plug/socket
----------------------------	--

## Connection data

Connection points	8
Total number of potentials	4

Subject to changes. Please also observe the further product documentation!



## Connection 1

Connection technology	Push-in CAGE CLAMP®
Actuation type	Operating tool Push-in
Nominal cross-section	4 mm <sup>2</sup> / 12 AWG
Solid conductor	0.5 ... 4 mm <sup>2</sup> / 20 ... 12 AWG
Solid conductor; push-in termination	1.5 ... 4 mm <sup>2</sup> / 16 ... 12 AWG
Stranded conductor	0.5 ... 2.5 mm <sup>2</sup> / 20 ... 14 AWG
Fine-stranded conductor	0.5 ... 4 mm <sup>2</sup> / 20 ... 12 AWG
Fine-stranded conductor; with insulated ferrule	0.25 ... 1.5 mm <sup>2</sup> / 20 ... 16 AWG
Fine-stranded conductor; with uninsulated ferrule	0.25 ... 2.5 mm <sup>2</sup> / 20 ... 14 AWG
Fine-stranded conductor; with ferrule; push-in termination	1.5 mm <sup>2</sup> / 16 AWG
Strip length	9 mm / 0.35 inches
Pole number	4
Conductor entry direction to mating direction	0°

## Physical data

Pin spacing	10 mm / 0.394 inches
Width	40 mm / 1.575 inches
Height	12.9 mm / 0.508 inches
Depth	37.5 mm / 1.476 inches

## Mechanical Data

Application	General mains applications
Coding	A
Variable coding	Yes
Marking	N $\frac{2}{L}$ 1/L'
Potential marking	N $\frac{2}{L}$ 1/L'
Mating force of a plug-in connection	approx. 20 ... 70 N (depending on pole number)
Retention force of a plug-in connection	Locked: > 80 N
Unmating force of a plug-in connection	Unlocked: approx. 20 ... 70 N (depending on pole number)
Number of mating cycles	200, without resistive load
Protection type	IP20; When mated and secured with a strain relief housing: IP2xC (These compact connectors are not designed for use in open, easily accessible areas!)

Subject to changes. Please also observe the further product documentation!



## Plug-in connection

Contact type (pluggable connector)	Female connector/socket
Connector (connection type)	for conductor
Mismating protection	Yes
Note on mismating protection	All <i>WINSTA</i> <sup>®</sup> components are 100% protected against mismating when: a.) plugging different numbers of poles b.) plugging while rotated 180 c.) plugging while laterally staggered d.) plugging one pole
Locking lever	Can be retrofitted
Locking of plug-in connection	locking lever
Note on locking system	All connectors for mounted installations (snap-in versions for lighting fixtures or devices, all types of PCB and distribution connectors) are factory-equipped with locking levers to ensure plugs and sockets are securely locked. Additional locking levers are only required for flying leads (plug/socket).

## Material Data

Note (material data)	Information on material specifications can be found here
Color	black
Cover color	gray
Material group	I
Insulation material	Polyamide (PA66)
Flammability class per UL94	V0
Clamping spring material	Chrome-nickel spring steel (CrNi)
Contact material	Copper or copper alloy; surface-treated
Contact plating	Tin
Fire load	0.215 MJ
Weight	12.4 g

## Environmental requirements

Processing temperature	-5 ... +40 °C
Continuous operating temperature	-35 ... +85 °C
Note on continuous operating temperature	Insulating parts for temperatures ≤ 105 °C

Subject to changes. Please also observe the further product documentation!

WAGO GmbH & Co. KG  
Hansastr. 27  
32423 Minden  
Phone: +49571 887-0 | Fax: +49571 887-169  
Email: [info.de@wago.com](mailto:info.de@wago.com) | Web: [www.wago.com](http://www.wago.com)

Do you have any questions about our products?  
We are always happy to take your call at +49 (571) 887-44222.

## Commercial data



Product Group	20 (Winsta)
eCl@ss 10.0	27-44-06-05
eCl@ss 9.0	27-44-06-05
ETIM 8.0	EC002560
ETIM 7.0	EC002560
PU (SPU)	50 pcs
Packaging type	box
Country of origin	DE
GTIN	4044918252270
Customs tariff number	85366990990

## Environmental Product Compliance

RoHS Compliance Status	Compliant, No Exemption
------------------------	-------------------------

## Approvals / Certificates

### General approvals

Logo	Approval	Additional Approval Text	Certificate name
	CCA DEKRA Certification B.V.	EN 61535	71- 123228
	CCA DEKRA Certification B.V.	IEC 61535	NL -84761
	cURus Underwriters Laboratories Inc.	UL 1977	E45171
	VDE VDE Prüf- und Zertifizierungsinstitut	EN 61984	40002889



### Declarations of conformity and manufacturer's declarations

Logo	Approval	Additional Approval Text	Certificate name
	EU-Declaration of Conformity WAGO GmbH & Co. KG	-	-









Subject to changes. Please also observe the further product documentation!



## Approvals for marine applications

Logo	Approval	Additional Approval Text	Certificate name
	<b>ABS</b> American Bureau of Shipping	-	19- HG1868589- PDA
	<b>DNV GL</b> Det Norske Veritas, Germanischer Lloyd	-	TAE00001Z6
	<b>LR</b> Lloyds Register	IEC 61984	LR22429487TA

## Counterpart

	<b>Item no.770-114</b> Plug; with strain relief housing; 4-pole; Cod. A; 4,00 mm <sup>2</sup> ; black	<a href="http://www.wago.com/770-114">www.wago.com/770-114</a>
	<b>Item no.770-214</b> Plug; 4-pole; Cod. A; 4,00 mm <sup>2</sup> ; black	<a href="http://www.wago.com/770-214">www.wago.com/770-214</a>
	<b>Item no.770-626</b> T-distribution connector; 4-pole; Cod. A; 1 input; 2 outputs; 2 locking levers; black	<a href="http://www.wago.com/770-626">www.wago.com/770-626</a>
	<b>Item no.770-627</b> T-distribution connector; 4-pole; Cod. A; 1 input; 2 outputs; 3 locking levers; for flying leads; black	<a href="http://www.wago.com/770-627">www.wago.com/770-627</a>
	<b>Item no.770-714</b> Snap-in plug; 4-pole; Cod. A; 4,00 mm <sup>2</sup> ; black	<a href="http://www.wago.com/770-714">www.wago.com/770-714</a>
	<b>Item no.770-714/007-000</b> Snap-in plug; with direct ground contact; 4-pole; Cod. A; 4,00 mm <sup>2</sup> ; black	<a href="http://www.wago.com/770-714/007-000">www.wago.com/770-714/007-000</a>
	<b>Item no.770-814</b> Plug for PCBs; straight; 4-pole; Cod. A; black	<a href="http://www.wago.com/770-814">www.wago.com/770-814</a>
	<b>Item no.770-814/011-000</b> Plug for PCBs; angled; 4-pole; Cod. A; black	<a href="http://www.wago.com/770-814/011-000">www.wago.com/770-814/011-000</a>

Subject to changes. Please also observe the further product documentation!



**Item no. 770-944**

h-distribution connector; 4-pole; Cod. A; 1 input; 2 outputs; outputs on one side; 2 locking levers; black

[www.wago.com/770-944](http://www.wago.com/770-944)



**Item no. 770-945**

h-distribution connector; 4-pole; Cod. A; 1 input; 2 outputs; outputs on one side; 3 locking levers; for flying leads; black

[www.wago.com/770-945](http://www.wago.com/770-945)



**Item no. 771-9994/006-101**

pre-assembled interconnecting cable; Eca; Socket/plug; 4-pole; Cod. A; H05VV-F 4G 1.5 mm<sup>2</sup>; 1 m; 1,50 mm<sup>2</sup>; black

[www.wago.com/771-9994/006-101](http://www.wago.com/771-9994/006-101)



**Item no. 771-9994/206-101**

pre-assembled connecting cable; Eca; Plug/open-ended; 4-pole; Cod. A; H05VV-F 4G 1.5 mm<sup>2</sup>; 1 m; 1,50 mm<sup>2</sup>; black

[www.wago.com/771-9994/206-101](http://www.wago.com/771-9994/206-101)

## Required accessories

### Strain relief

#### Strain relief housing



**Item no.: 770-504/023-000**

Strain relief housing; 4-pole; for 2 cables; 5.0 ... 9.0 mm; 55 mm; black

[www.wago.com/770-504/023-000](http://www.wago.com/770-504/023-000)



**Item no.: 770-514**

Strain relief housing; 4-pole; for 2 cables; 9.0 ... 13.0 mm; 55 mm; white

[www.wago.com/770-514](http://www.wago.com/770-514)



**Item no.: 770-504**

Strain relief housing; 4-pole; for 2 cables; 9.0 ... 13.0 mm; 55 mm; black

[www.wago.com/770-504](http://www.wago.com/770-504)



**Item no.: 770-514/023-000**

Strain relief housing; 4-pole; for 2 cables; 5.0 ... 9.0 mm; 55 mm; white

[www.wago.com/770-514/023-000](http://www.wago.com/770-514/023-000)

### Locking levers

#### Locking system



**Item no.: 770-121**

Locking lever; for flying leads; for manual operation; white

[www.wago.com/770-121](http://www.wago.com/770-121)



**Item no.: 770-131**

Locking lever; for flying leads; for tool operation; white

[www.wago.com/770-131](http://www.wago.com/770-131)

Subject to changes. Please also observe the further product documentation!

WAGO GmbH & Co. KG

Hansastr. 27

32423 Minden

Phone: +49571 887-0 | Fax: +49571 887-169

Email: [info.de@wago.com](mailto:info.de@wago.com) | Web: [www.wago.com](http://www.wago.com)

Do you have any questions about our products?

We are always happy to take your call at +49 (571) 887-44222.



**Item no.: 770-101**  
Locking lever; for flying leads; for manual operation; black

[www.wago.com/770-101](http://www.wago.com/770-101)



**Item no.: 770-111**  
Locking lever; for flying leads; for tool operation; black

[www.wago.com/770-111](http://www.wago.com/770-111)

## Cover

### Cover



**Item no.: 770-201**  
Lockout cap; 12-pole, separable; for sockets; Plastic; black

[www.wago.com/770-201](http://www.wago.com/770-201)



**Item no.: 770-221**  
Lockout cap; 12-pole, separable; for sockets; Plastic; white

[www.wago.com/770-221](http://www.wago.com/770-221)

## Optional accessories

### Marking accessories

#### Marker



**Item no.: 770-450/000-002**  
Marker card; Plastic; yellow

[www.wago.com/770-450/000-002](http://www.wago.com/770-450/000-002)



**Item no.: 770-450/000-001**  
Marker card; Plastic; green

[www.wago.com/770-450/000-001](http://www.wago.com/770-450/000-001)



**Item no.: 770-450/000-005**  
Marker card; Plastic; red

[www.wago.com/770-450/000-005](http://www.wago.com/770-450/000-005)



**Item no.: 770-450**  
Marker card; Plastic; white

[www.wago.com/770-450](http://www.wago.com/770-450)



**Item no.: 770-450/000-006**  
Marker card; Plastic; blue

[www.wago.com/770-450/000-006](http://www.wago.com/770-450/000-006)



**Item no.: 770-450/000-012**  
Marker card; Plastic; orange

[www.wago.com/770-450/000-012](http://www.wago.com/770-450/000-012)

Subject to changes. Please also observe the further product documentation!



## Tool

Operating tool



Item no.: 210-719

Operating tool; Blade: 2.5 x 0.4 mm; with a partially insulated shaft

[www.wago.com/210-719](http://www.wago.com/210-719)

## Cover

Cover



Item no.: 897-2005

Protective cap; Type4; for sockets and plugs; PVC; red

[www.wago.com/897-2005](http://www.wago.com/897-2005)

## Mounting

Snap-in frame



Item no.: 770-319

Snap-in frame; 4-pole; 1.0 ... 3.0 mm; black

[www.wago.com/770-319](http://www.wago.com/770-319)



Item no.: 770-339

Snap-in frame; 4-pole; 1.0 ... 3.0 mm; black

[www.wago.com/770-339](http://www.wago.com/770-339)

## Downloads

### Documentation

#### Bid Text

770-204 X81 - Datei	2019 Feb 19	xml 3.0 kB	Download
770-204 docx - Datei	2018 Apr 10	docx 14.7 kB	Download

### CAD/CAE-Data

#### CAE data

EPLAN Data Portal 770-204	URL	Download
WSCAD Universe 770-204	URL	Download
ZUKEN Portal 770-204	URL	Download

Subject to changes. Please also observe the further product documentation!

## CAD data

2D/3D Models 770-204

[URL](#)

[Download](#)

## Environmental Product Compliance

### Compliance Search

Environmental Product Compliance 770-204

[URL](#)

[Download](#)

Socket; 4-pole; Cod. A; 4,00 mm<sup>2</sup>; black

## Installation Notes

### Conductor termination

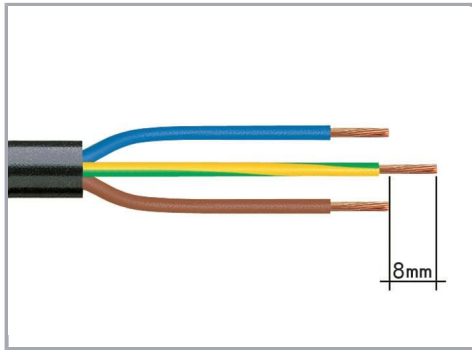

1. Strip length, outer insulation = 35 mm (2-pole), 55 mm (3- to 5-pole)

2. Strip length = 9 mm

3. Extended ground conductor = 8 mm

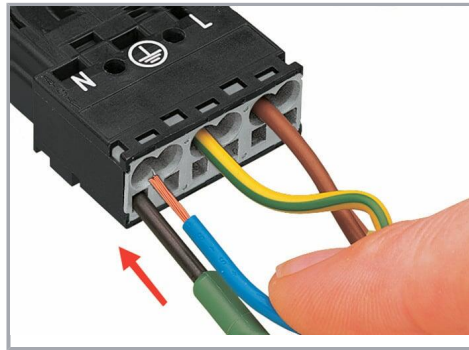

To terminate fine-stranded conductors, open the clamping unit via screwdriver (2.5 mm blade width) and insert a stripped conductor until it hits the backstop.

Subject to changes. Please also observe the further product documentation!

WAGO GmbH & Co. KG

Hansastr. 27

32423 Minden

Phone: +49571 887-0 | Fax: +49571 887-169

Email: [info.de@wago.com](mailto:info.de@wago.com) | Web: [www.wago.com](http://www.wago.com)

Do you have any questions about our products?

We are always happy to take your call at +49 (571) 887-44222.

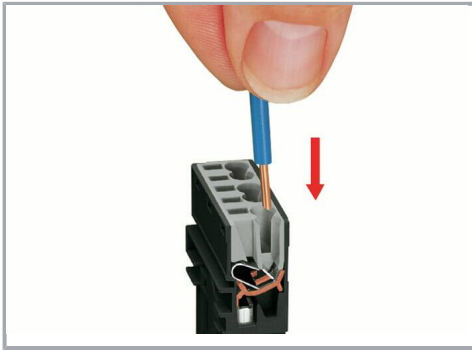

Insert the stripped solid conductor until it hits the backstop.

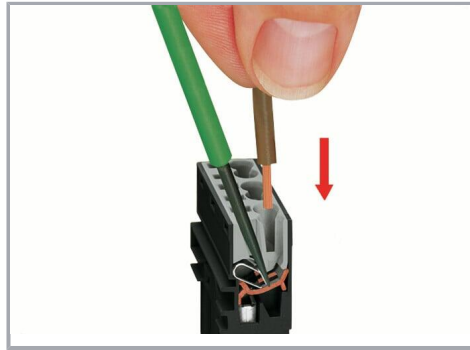

To terminate fine-stranded conductors, open the clamping unit via screwdriver (2.5 mm blade width) and insert a stripped conductor until it hits the backstop.

#### Conductor removal

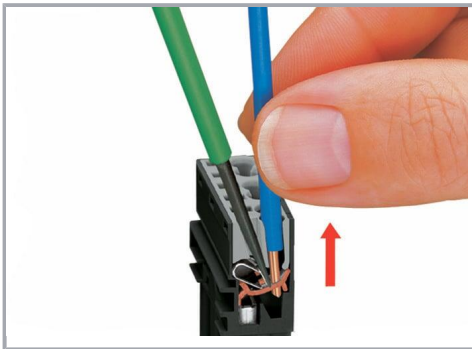

To remove the conductor, actuate the clamp via screwdriver (2.5 mm blade width) and pull out the conductor.

#### Installation

Subject to changes. Please also observe the further product documentation!

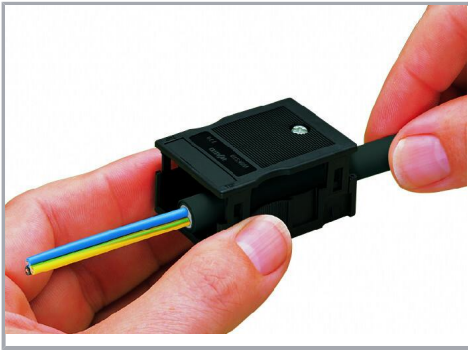

We recommend pulling the pre-latched strain relief housing over the cable prior to termination. However, the strain relief can be mounted at a later time as well.

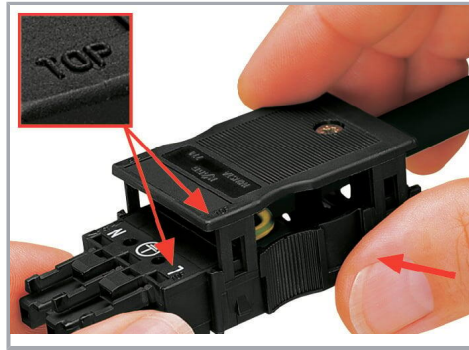

Latch the strain relief housing onto the plug /socket. Note the "TOP" inscription.

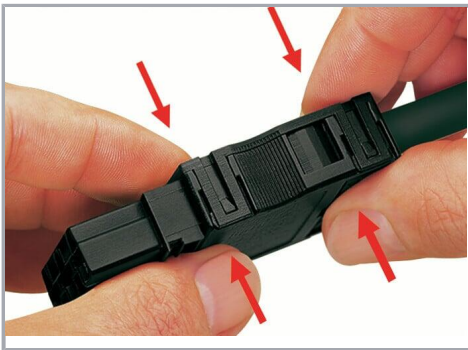

Prepare strain relief housing by snapping together upper and bottom part.



Tighten strain relief screw with screwdriver (2.5 mm blade width).

## Product family

**WINSTA® MIDI**

[Show all products from the family](#)

Subject to changes. Please also observe the further product documentation!