

High IIP3 PIN Diode Variable Attenuator 0.8 - 1.0 GHz

Rev. V4

Features

- 1.0 dB Insertion Loss, Typical
- 12 dB Return Loss, Typical
- 25 dB Attenuation, Typical
- 45 dBm IIP3, Typical (1MHz Offset, @ +0dBm Pinc)
- SOIC-8 Surface Mount Package
- RoHs Compliant

Extra Features

- Covers the following Bands:
 - GSM
 - AMPS
- Usable Bandwidth: 0.60 GHz to 1.20 GHz
- 1.5 dB Insertion Loss, Typical
- 1.8:1 VSWR, Typical
- 18.5 dB Attenuation, Typical

Description and Applications

M/A-COM's MA4VAT904-1061T is a HMIC PIN Diode Variable Attenuator which utilizes an integrated 90 degree 3dB hybrid with a pair of Silicon PIN Diodes to perform the required attenuation function as D.C. Voltage (Current) is applied.

This device operates from 0 to 1.9 Volts at 1.89 mA typical control current for maximum attenuation. The user can add external biasing resistors to the bias ports for higher voltage requirements as required.

M/A-COM's MA4VAT904-1061T PIN Diode Variable Attenuator is designed for AGC Circuit Applications requiring:

- Lower Insertion Loss
- Lower distortion through attenuation
- Larger dynamic range for wide spread spectrum applications

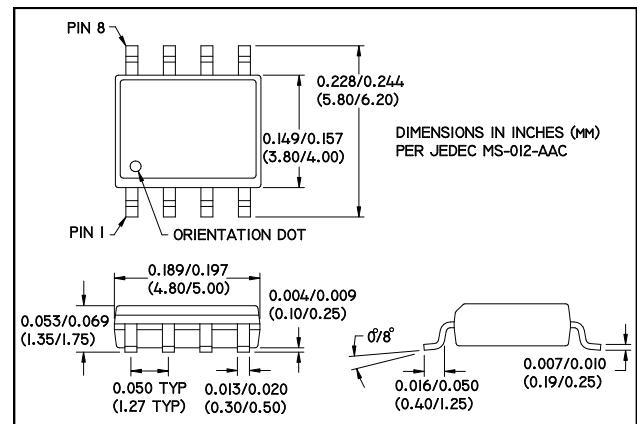

SOIC-8 PIN Configuration (Topview)

PIN	Function	Comments
1	DC1	
2	GND	
3	GND	
4	RFin/out	Symmetrical as RF Input/Ouput
5	RFout/in	Symmetrical as RF Input/Ouput
6	GND	
7	GND	
8	DC2	

Absolute Maximum Ratings @ +25 °C ^{1,2}

Parameter	Maximum Ratings
Operating Temperature	-40 °C to +85 °C
Storage Temperature	-65 °C to +150 °C
Junction Temperature	+175 °C
RF C.W. Incident Power	+33 dBm C.W.
Reversed Current @ -30 V	50nA
Control Current	50 mA per Diode

1. All the above values are at +25 °C, unless otherwise noted.
2. Exceeding these limits may cause permanent damage.

High IIP3 PIN Diode Variable Attenuator 0.8 - 1.0 GHz

Rev. V4

Electrical Specifications @ +25 °C

Parameter	Frequency Band	Unit	Min	Typ	Max
No DC Bias RF Parameter					
Insertion Loss	0.80 GHz—1.00 GHz	dB	-	1.0	1.2
Input Return Loss		dB	11	12	-
Output Return Loss		dB	11	12	-
P1dB		dBm	30	-	-
Input IP3		dBm	45	49	-
Control Voltage		V	-	0 V @ 0uA	-
DC Bias RF Parameter					
Maximum Attenuation	0.80 GHz—1.00 GHz	dB	18.5	24	-
Input Return Loss @ Max Attenuation		dB	15	21	-
Output Return Loss @ Max Attenuation		dB	15	21	-
Input IP3		dBm	36	39	-
Control Voltage @ Max Attenuation		V	-	1.9 V @ 1.89 mA	-
Control Current @ Max Attenuation	Bias = 1.9V	mA	1.2	1.8	2.4

Typical RF Performance Over Industry Designated RF Frequency Bands ^{3,4}

Band		Freq	I. Loss	Att.	R. Loss	IIP3	Phase -Relative-
		(MHz)	(dB)	(dB)	(dB)	(dBm)	(Degree)
AMPS	RX	824-849	0.9	22	12	45	-15°
	TX	869-894	0.9	22	12	45	
GSM	RX	880-915	1.2	20	11	45	-20°
	TX	925-960	1.2	20	11	45	

3. All are typical values only.

4. Relative phase is the measured Insertion Phase difference between Insertion Loss and 15 dB Attenuation.
(Please refer to the plots below)

Plots of Typical RF Characteristics @ +25 °C

Typical Insertion Loss & Attenuation

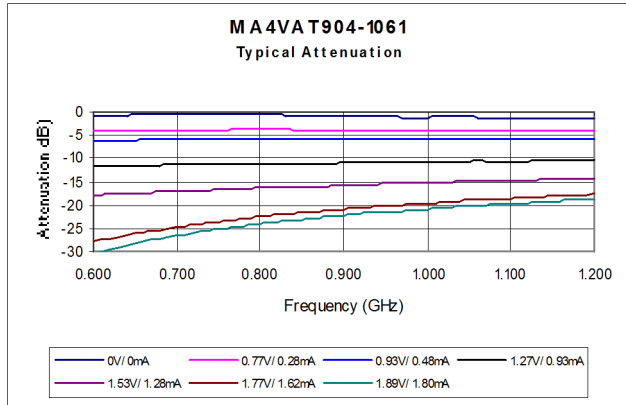

Typical Attenuation vs Voltage

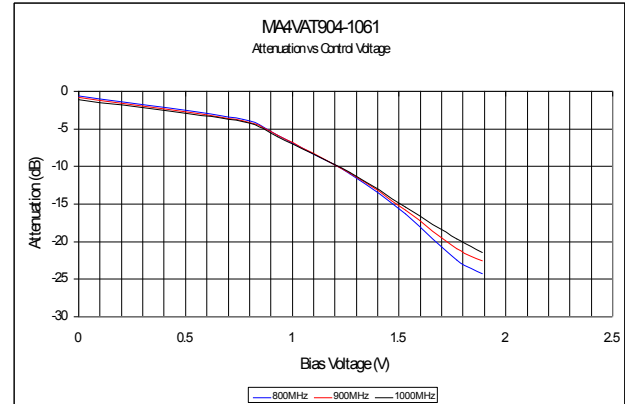

Typical Return Loss @ All Attenuation Levels

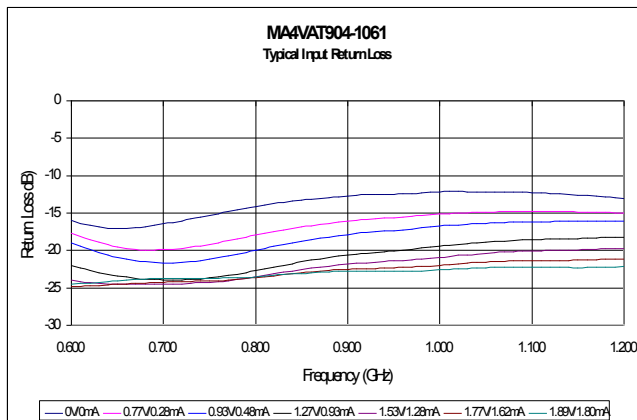

Typical IIP3 vs Attenuation

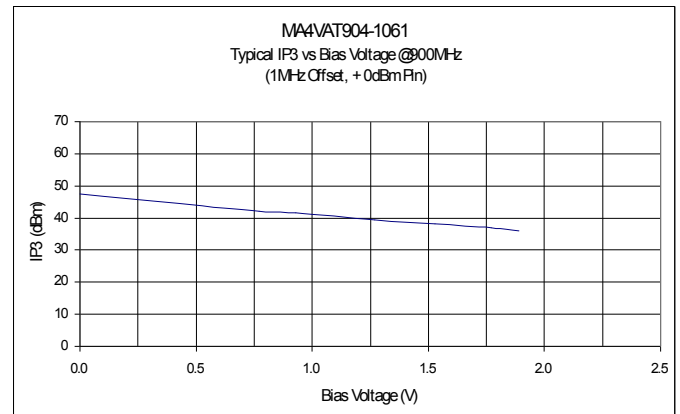

Typical Relative Phase Shift Per Attenuation (Voltage)

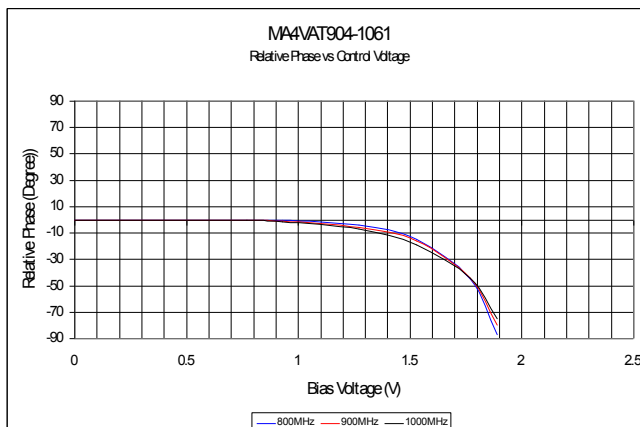

For Reference ONLY:

- Insertion Loss = 0.00 V @ 0.00 mA
- 5dB Attenuation = 0.94 V @ 0.49 mA
- 10dB Attenuation = 1.26 V @ 0.93 mA
- 15dB Attenuation = 1.50 V @ 1.22 mA
- 20dB Attenuation = 1.77V @ 1.60 mA

High IIP3 PIN Diode Variable Attenuator 0.8 - 1.0 GHz

Rev. V4

Package PIN Designation, External Components, and Equivalent Circuit

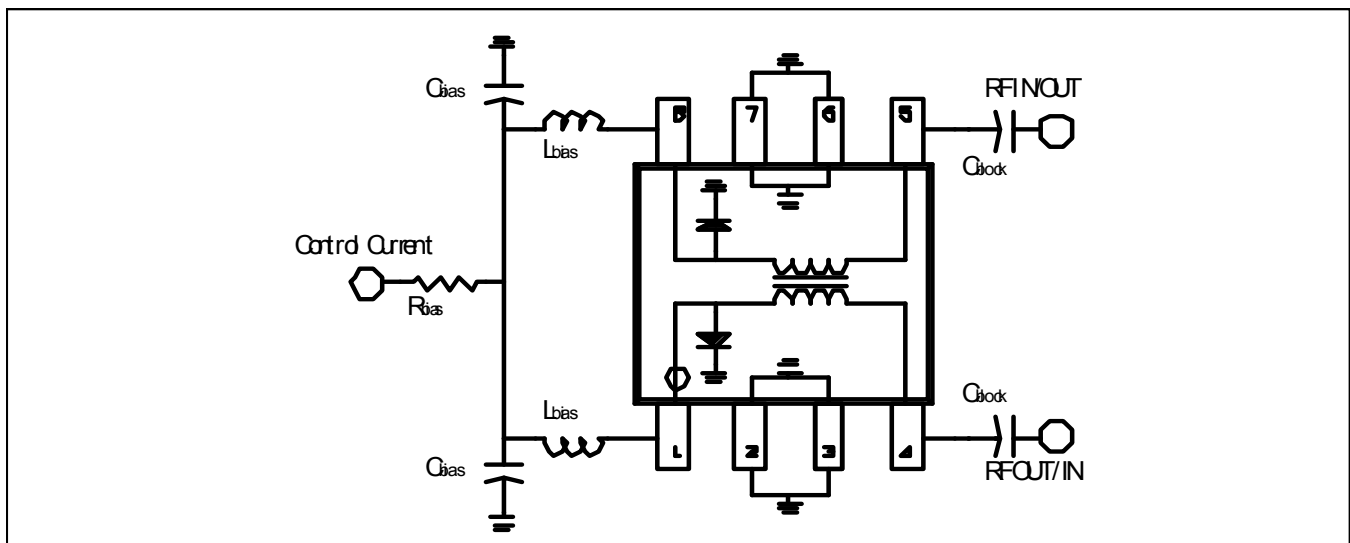
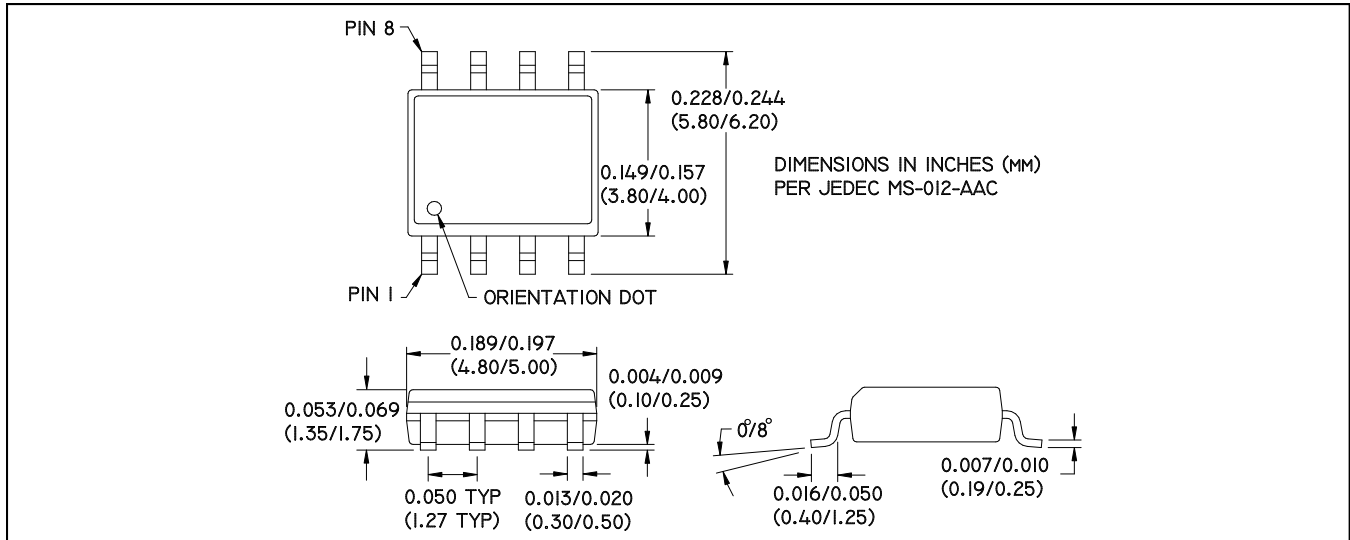

External Bias Components

$R_{bias} = 680 \text{ Ohms (1.66 V, @1.50 mA)}$

$L_{bias} = 150 \text{ nH}$

$C_{bias} = 100 \text{ pF}$

$C_{block} = 100 \text{ pF}$

M/A-COM Technology Solutions Inc. All rights reserved.

Information in this document is provided in connection with M/A-COM Technology Solutions Inc ("MACOM") products. These materials are provided by MACOM as a service to its customers and may be used for informational purposes only. Except as provided in MACOM's Terms and Conditions of Sale for such products or in any separate agreement related to this document, MACOM assumes no liability whatsoever. MACOM assumes no responsibility for errors or omissions in these materials. MACOM may make changes to specifications and product descriptions at any time, without notice. MACOM makes no commitment to update the information and shall have no responsibility whatsoever for conflicts or incompatibilities arising from future changes to its specifications and product descriptions. No license, express or implied, by estoppel or otherwise, to any intellectual property rights is granted by this document.

THESE MATERIALS ARE PROVIDED "AS IS" WITHOUT WARRANTY OF ANY KIND, EITHER EXPRESS OR IMPLIED, RELATING TO SALE AND/OR USE OF MACOM PRODUCTS INCLUDING LIABILITY OR WARRANTIES RELATING TO FITNESS FOR A PARTICULAR PURPOSE, CONSEQUENTIAL OR INCIDENTAL DAMAGES, MERCHANTABILITY, OR INFRINGEMENT OF ANY PATENT, COPYRIGHT OR OTHER INTELLECTUAL PROPERTY RIGHT. MACOM FURTHER DOES NOT WARRANT THE ACCURACY OR COMPLETENESS OF THE INFORMATION, TEXT, GRAPHICS OR OTHER ITEMS CONTAINED WITHIN THESE MATERIALS. MACOM SHALL NOT BE LIABLE FOR ANY SPECIAL, INDIRECT, INCIDENTAL, OR CONSEQUENTIAL DAMAGES, INCLUDING WITHOUT LIMITATION, LOST REVENUES OR LOST PROFITS, WHICH MAY RESULT FROM THE USE OF THESE MATERIALS.

MACOM products are not intended for use in medical, lifesaving or life sustaining applications. MACOM customers using or selling MACOM products for use in such applications do so at their own risk and agree to fully indemnify MACOM for any damages resulting from such improper use or sale.