

BMD-350

Stand-alone Bluetooth 5 low energy module

Data sheet



Abstract

This technical data sheet describes the BMD-350 stand-alone Bluetooth® low energy module. The OEMs can embed their own application on top of the integrated Bluetooth low energy stack using Nordic Semiconductor SDK integrated development environment (IDE).

Document information

| | | |
|-------------------------------|---|-------------|
| Title | BMD-350 | |
| Subtitle | Stand-alone Bluetooth 5 low energy module | |
| Document type | Data sheet | |
| Document number | UBX-19033354 | |
| Revision and date | R28 | 16-May-2022 |
| Disclosure restriction | C1 Public | |

| Product status | Corresponding content status | |
|--------------------------------------|-------------------------------------|--|
| Functional sample | Draft | For functional testing. Revised and supplementary data will be published later. |
| In development / Prototype | Objective specification | Target values. Revised and supplementary data will be published later. |
| Engineering sample | Advance information | Data based on early testing. Revised and supplementary data will be published later. |
| Initial production | Early production information | Data from product verification. Revised and supplementary data may be published later. |
| Mass production / End of life | Production information | Document contains the final product specification. |

This document applies to the following products:

| Product name | Type number | Firmware version | IN/PCN reference | Product status |
|---------------------|--------------------|-------------------------|-------------------------|-----------------------|
| BMD-350 | BMD-350-A-R-00 | All | UBX-20009871 | Obsolete |
| BMD-350 | BMD-350-A-R-10 | AE | N/A | Mass production |

u-blox or third parties may hold intellectual property rights in the products, names, logos and designs included in this document. Copying, reproduction, modification or disclosure to third parties of this document or any part thereof is only permitted with the express written permission of u-blox.

The information contained herein is provided "as is" and u-blox assumes no liability for its use. No warranty, either express or implied, is given, including but not limited to, with respect to the accuracy, correctness, reliability and fitness for a particular purpose of the information. This document may be revised by u-blox at any time without notice. For the most recent documents, visit www.u-blox.com.

Copyright © u-blox AG.

Contents

| | |
|--|-----------|
| Document information | 2 |
| Contents | 3 |
| 1 Functional description | 6 |
| 1.1 Features | 6 |
| 1.2 Applications | 7 |
| 1.3 Block diagram | 7 |
| 1.4 Product specifications | 8 |
| 2 Pin definition | 10 |
| 2.1 Pin assignment..... | 10 |
| 2.2 Peripheral pin assignments | 11 |
| 3 Electrical specifications | 12 |
| 3.1 Absolute maximum ratings | 12 |
| 3.2 Operating conditions | 12 |
| 3.3 General purpose I/O | 12 |
| 3.4 Module reset | 13 |
| 3.5 Debug and programming..... | 13 |
| 3.6 Clocks | 13 |
| 3.6.1 32.768 kHz crystal (LFXO)..... | 14 |
| 3.6.2 32.768 kHz clock source comparison | 14 |
| 4 Firmware | 15 |
| 4.1 Factory image | 15 |
| 4.1.1 Firmware version “AA” | 15 |
| 4.1.2 Firmware version “AB” | 15 |
| 4.1.3 Firmware version “AC” | 15 |
| 4.1.4 Firmware version “AD” | 16 |
| 4.1.5 Firmware version “AE” | 16 |
| 4.2 Module programming and read-back protection | 16 |
| 4.3 SoftDevices | 16 |
| 4.3.1 S132 | 17 |
| 4.3.2 S212 | 17 |
| 4.3.3 S332 | 17 |
| 4.4 Bluetooth device address | 17 |
| 5 Mechanical specifications | 18 |
| 5.1 Dimensions | 18 |
| 5.2 Recommended PCB land pads | 18 |
| 5.3 Module marking..... | 19 |
| 5.3.1 Module marking for type number BMD-350-A-R-00..... | 19 |
| 5.3.2 Module marking for type number BMD-350-A-R-10..... | 19 |
| 6 RF Design notes | 21 |
| 6.1 Recommended RF layout and ground plane..... | 21 |

| | | |
|-----------|--|-----------|
| 6.2 | Mechanical enclosure..... | 21 |
| 6.3 | Antenna patterns..... | 22 |
| 6.3.1 | X-Y plane..... | 22 |
| 6.3.2 | X-Z plane..... | 23 |
| 6.3.3 | Y-Z plane..... | 23 |
| 7 | BMD-350 evaluation development kit..... | 24 |
| 8 | Qualification and approvals..... | 25 |
| 8.1 | United States (FCC) | 25 |
| 8.1.1 | Labeling and user information requirements | 25 |
| 8.1.2 | RF exposure | 25 |
| 8.2 | Canada (ISED)..... | 26 |
| 8.2.1 | Labeling and user information requirements | 26 |
| 8.2.2 | RF exposure | 26 |
| 8.3 | European Union regulatory compliance | 27 |
| 8.3.1 | Radio Equipment Directive (RED) 2014/53/EU | 27 |
| 8.3.2 | Labeling and user information requirements | 27 |
| 8.4 | Japan (MIC)..... | 27 |
| 8.5 | Australia / New Zealand (RCM)..... | 28 |
| 8.6 | South Korea (KCC)..... | 28 |
| 8.7 | Brazil (ANATEL)..... | 28 |
| 8.8 | Eurasia (EAC)..... | 28 |
| 8.9 | Mexico (IFETEL)..... | 29 |
| 8.10 | China (SRRC)..... | 29 |
| 8.11 | Bluetooth qualification..... | 29 |
| 9 | Environmental..... | 30 |
| 9.1 | RoHS | 30 |
| 9.2 | REACH | 30 |
| 9.3 | California proposition 65 (P65) | 30 |
| 10 | Product handling..... | 31 |
| 10.1 | Packaging | 31 |
| 10.1.1 | Reel packaging for type number BMD-350-A-R-00..... | 31 |
| 10.1.2 | Reel packaging for type number BMD-350-A-R-10..... | 31 |
| 10.1.3 | Carrier tape dimensions for type number BMD-350-A-R-00 | 31 |
| 10.1.4 | Carrier tape dimensions for type number BMD-350-A-R-10 | 32 |
| 10.2 | Carrier tape orientation | 32 |
| 10.3 | Moisture sensitivity level..... | 32 |
| 10.4 | Reflow soldering | 33 |
| 10.5 | ESD precautions..... | 33 |
| 11 | Ordering information..... | 34 |
| 12 | Life support and high-risk use warnings | 35 |
| | Related documents | 36 |
| | Revision history | 37 |

Contact..... 37

1 Functional description

The BMD-350 from u-blox is a powerful, highly flexible, ultra-low power, Bluetooth Low energy module based on the nRF52832 SoC from Nordic Semiconductor. With an Arm® Cortex®-M4 with FPU 32-bit processor, embedded 2.4GHz transceiver, and integrated antenna, BMD-350 provides a complete RF solution with no additional RF design, allowing faster time to market. Providing full use of the nRF52832's capabilities and peripherals, the BMD-350 can power the most demanding applications, all while simplifying designs and reducing BOM costs. With an internal DC-DC converter and intelligent power control, BMD-350 provides class-leading power efficiency, enabling ultra-low power sensitive applications. Regulatory pre-approvals reduce the burden to enter the market.

1.1 Features

- Based on the Nordic Semiconductor nRF52832 SoC
- Bluetooth 5 PHYs: LE 1M, LE 2M
- Bluetooth 5 features: Advertising Extensions, Channel Selection Algorithm #2
- Bluetooth Mesh
- Complete RF solution with an integrated DC-DC converter
- Nordic Semiconductor SoftDevice ready
- Over-the-Air (OTA) firmware updates
- No external components required
- Arm® Cortex®-M4 with FPU 32-bit processor
- 512 kB embedded flash memory
- 64 KB RAM
- -40 °C to +85 °C Temperature Range
- 32 General Purpose I/O Pins
- 12-bit/200 KSPS ADC
- Serial Wire Debug (SWD)
- Three SPI Master/Slave (8 Mbps)
- Two 2-wire Master/Slave (I2C compatible)
- UART (w/ CTS/RTS and DMA)
- I2S audio interface
- Low power comparator
- Temperature sensor
- Random number generator
- 20 channel CPU independent Programmable Peripheral Interconnect (PPI)
- Quadrature Demodulator (QDEC)
- 128-bit AES HW encryption
- 5 x 32 bit, 3 x 24 bit Real Timer Counters (RTC)
- NFC-A tag interface for OOB pairing
- Dimensions: 8.65 x 6.4 x 1.5 mm
- USA (FCC): 2AA9B05
- Canada (IC): 12208A-05
- Japan (MIC): 210-10894

1.2 Applications

- Beacons – iBeacon™, Eddystone, AltBeacon, and so on.
- Low-power Sensors
- Fitness devices
- Wearables
- Climate control
- Lighting
- Safety and security
- Home appliances
- Access control
- Internet of Things
- Home health care
- Advanced remote controls
- Smart energy management
- Low-power sensor networks
- Interactive entertainment
- Key fobs
- Environmental monitoring
- Hotel automation
- Office automation

1.3 Block diagram

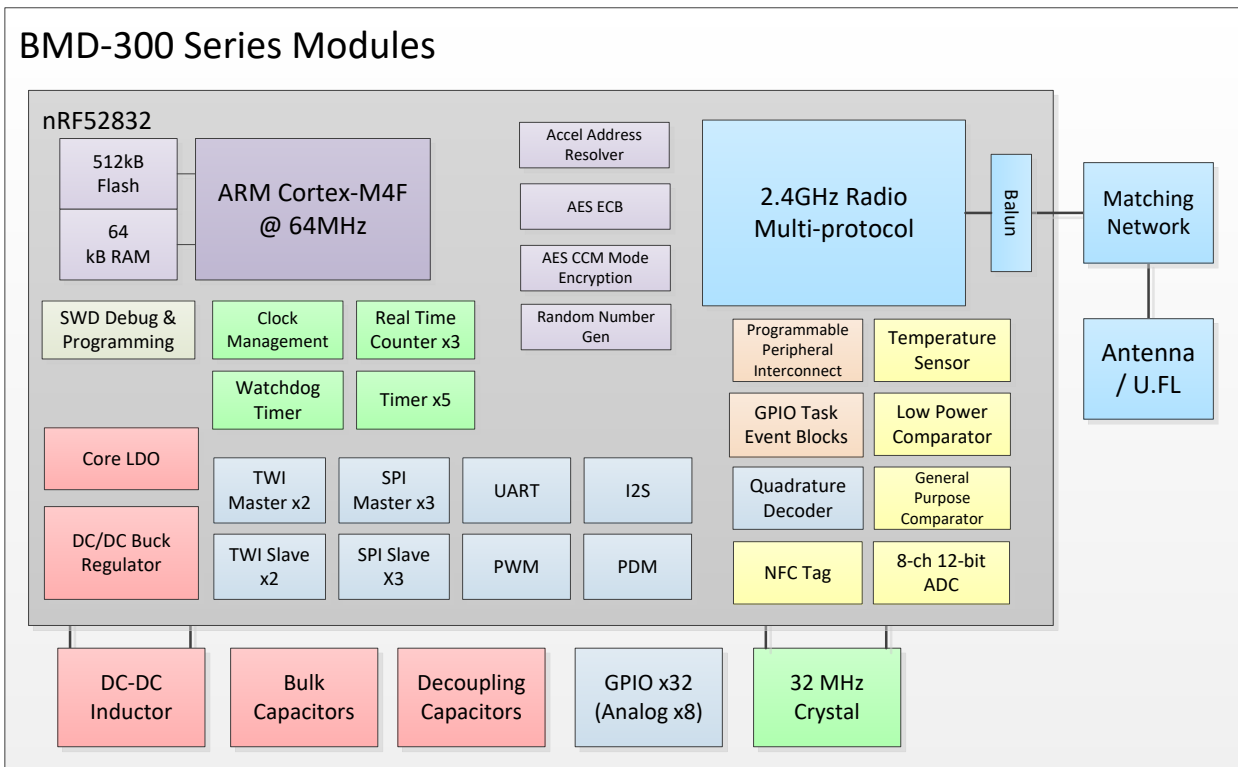

Figure 1: Block diagram

1.4 Product specifications

| Detail | Description |
|--|--|
| Bluetooth | |
| Bluetooth version | Bluetooth 5 low energy, Concurrent Central & Peripheral (S132), 2M LE PHY, 1M LE PHY, Advertising Extensions, CSA #2 Bluetooth Mesh |
| Security | AES-128 |
| LE connections | Concurrent central, observer, peripheral, and broadcaster roles with up to twenty concurrent connections along with one Observer and one Broadcaster (S132) |
| Radio | |
| Frequency | 2.360 GHz to 2.500 GHz |
| Modulations | GFSK at 1 Mbps, 2 Mbps data rates |
| Transmit power | +4 dBm maximum |
| Receiver sensitivity | -96 dBm (Bluetooth low energy mode) |
| Antenna | Ceramic chip (1 dBi peak) |
| Current consumption | |
| TX only @ +4 dBm, 0 dBm @ 3V, DCDC enabled | 7.5 mA, 5.3 mA |
| TX only @ +4 dBm, 0 dBm | 16.6 mA, 11.6 mA |
| RX only @ 1 Mbps @ 3V, DCDC enabled | 5.4 mA |
| RX only @ 1 Mbps | 11.7 mA |
| CPU @ 64 MHz from flash, from RAM | 7.4 mA, 6.7 mA |
| CPU @ 64 MHz from flash, from RAM @ 3V, DCDC | 3.7 mA, 3.3 mA |
| System Off, On | 0.3 μ A, 1.2 μ A |
| Additional current for RAM retention | 30 nA / 4 KB block |
| Dimensions | |
| BMD-350 | Length: 8.65 mm \pm 0.2 mm |
| | Width: 6.4 mm \pm 0.2 mm |
| | Height: 1.5 mm \pm 0.1 mm |
| Hardware | |
| Interfaces | SPI Master/Slave x 3 UART Two-Wire Master/Slave (I2C) x 2 GPIO x 32 I2S PWM PDM |
| Power supply | 1.7 V to 3.6 V |
| Temperature range | -40 $^{\circ}$ C to +85 $^{\circ}$ C |
| Certifications | |
| USA (FCC) | FCC part 15 modular certification FCC ID: 2AA9B05 |
| Canada (IC) | Industry Canada RSS-210 modular certification IC: 12208A-05 |
| Europe (CE) | EN 60950-1: A2:2013 3.1 (a): Health and Safety of the User EN 301 489-1 V2.1.1 and 3.1 (b): Electromagnetic Compatibility EN 301 489-17 V3.1.1 EN 300 328 V2.1.1 3.2: Effective use of spectrum allocated |
| Japan (MIC) | Ministry of Internal Affairs and Communications (MIC) of Japan pursuant to the Radio Act of Japan: MIC: 210-108944 |

| Detail | Description |
|-------------------------------|--|
| Australia / New Zealand (RCM) | AS/NZS 4268:2017, Radio equipment and systems – Short range devices |
| Brazil (ANATEL) | The BMD-350 is evaluated according to: Resolution 680 of 27/06/2017, Act 14448 of 04/12/2017, Certificate number: 00857-21-05903 |
| Eurasia (EAC) | EA3C N RU Д-US.HA27.B.00650/18 |
| Mexico (IFETEL) | IFT #: RCPRIBM18-1491 |
| China (SRRC) | CMIIT ID: 2018DJ7255 |
| South Korea (KCC) | KCC ID: R-C-Rgd-BMD-350 |
| Bluetooth | BMD-350 BT5 RF-PHY Component (Tested) – DID: D037298; QDID: 101625 |
| Radio chip | |
| Nordic Semiconductor nRF52832 | Additional details: nRF52832 Product Specification Software Development Kit |

Table 1: Product specifications

2 Pin definition

2.1 Pin assignment

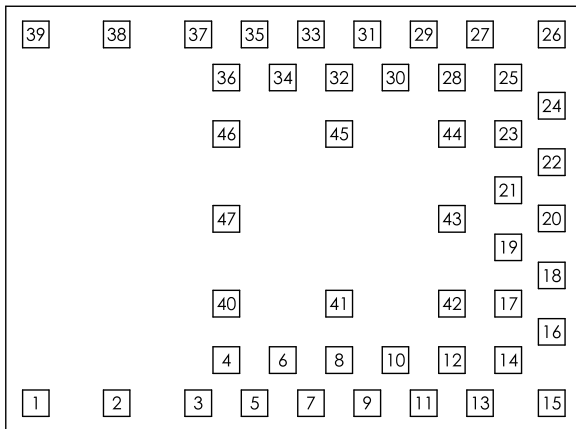

Figure 2: BMD-350 Pin assignment (top view)

| No. | Name | I/O | Description | nRF52 port | Remarks |
|-----|-------|-------|-------------------------|------------|--|
| 1 | GND | Power | Electrical Ground | | |
| 2 | GND | Power | Electrical Ground | | |
| 3 | GND | Power | Electrical Ground | | |
| 4 | SWCLK | I | SWD Clock | SWCLK | |
| 5 | SWDIO | I/O | SWD IO | SWDIO | |
| 6 | P0.20 | I/O | GPIO/TRACECLK | P0.20 | |
| 7 | P0.21 | I/O | GPIO/RESET_N | P0.21 | May be used as active low reset input |
| 8 | P0.18 | I/O | GPIO/TRACEDATA[0]/SWO | P0.18 | |
| 9 | P0.16 | I/O | GPIO/TRACEDATA[1] | P0.16 | |
| 10 | P0.17 | I/O | GPIO | P0.17 | |
| 11 | P0.15 | I/O | GPIO/TRACEDATA[2] | P0.15 | |
| 12 | P0.13 | I/O | GPIO | P0.13 | |
| 13 | P0.12 | I/O | GPIO | P0.12 | |
| 14 | P0.14 | I/O | GPIO/TRACEDATA[3] | P0.14 | |
| 15 | GND | Power | Electrical Ground | | |
| 16 | P0.09 | I/O | GPIO/NFC1 | P0.09 | NFC pin 1 (default) |
| 17 | P0.10 | I/O | GPIO/NFC2 | P0.10 | NFC pin 2 (default) |
| 18 | P0.11 | I/O | GPIO | P0.11 | |
| 19 | P0.06 | I/O | GPIO | P0.06 | |
| 20 | P0.08 | I/O | GPIO | P0.08 | |
| 21 | P0.05 | I/O | GPIO/AIN3 | P0.05 | Pin is analog capable |
| 22 | P0.07 | I/O | GPIO | P0.07 | |
| 23 | P0.01 | I/O | GPIO/XTAL2 (32.768 kHz) | P0.01 | |
| 24 | P0.00 | I/O | GPIO/XTAL1 (32.768 kHz) | P0.00 | |
| 25 | VCC | Power | +1.7 V to +3.6 V | VDD | An internal 4.7 μ F bulk capacitor is included on the module. However, it is good design practice to add additional bulk capacitance as required for your application, that is, those with heavy GPIO usage and/or current draw. |
| 26 | GND | Power | Electrical Ground | | |

| No. | Name | I/O | Description | nRF52 port | Remarks |
|-----|-------|-------|-------------------|------------|--|
| 27 | P0.04 | I/O | GPIO/AIN2 | P0.04 | Pin is analog capable |
| 28 | P0.02 | I/O | GPIO/AIN0 | P0.02 | Pin is analog capable |
| 29 | P0.30 | I/O | GPIO/AIN6 | P0.30 | Pin is analog capable, use as low drive, low frequency GPIO only |
| 30 | P0.31 | I/O | GPIO/AIN7 | P0.31 | Pin is analog capable, use as low drive, low frequency GPIO only |
| 31 | P0.29 | I/O | GPIO/AIN5 | P0.29 | Pin is analog capable, use as low drive, low frequency GPIO only |
| 32 | P0.27 | I/O | GPIO | P0.27 | Use as low drive, low frequency GPIO only |
| 33 | P0.25 | I/O | GPIO | P0.25 | Use as low drive, low frequency GPIO only |
| 34 | P0.26 | I/O | GPIO | P0.26 | Use as low drive, low frequency GPIO only |
| 35 | P0.23 | I/O | GPIO | P0.23 | Use as low drive, low frequency GPIO only |
| 36 | P0.24 | I/O | GPIO | P0.24 | Use as low drive, low frequency GPIO only |
| 37 | GND | Power | Electrical Ground | | |
| 38 | GND | Power | Electrical Ground | | |
| 39 | GND | Power | Electrical Ground | | |
| 40 | GND | Power | Electrical Ground | | |
| 41 | P0.22 | I/O | GPIO | P0.22 | Use as low drive, low frequency GPIO only |
| 42 | P0.19 | I/O | GPIO | P0.19 | |
| 43 | GND | Power | Electrical Ground | | |
| 44 | P0.03 | I/O | GPIO/AIN1 | P0.03 | Pin is analog capable |
| 45 | P0.28 | I/O | GPIO/AIN4 | P0.28 | Pin is analog capable, use as low drive, low frequency GPIO only |
| 46 | GND | Power | Electrical Ground | | |
| 47 | GND | Power | Electrical Ground | | |

Table 2: BMD-350 pin-out

2.2 Peripheral pin assignments

The peripherals within the BMD-350 may be assigned to nearly any of the GPIO pins through the application. There are some restrictions called out by the nRF52832 product specification. See the Remarks column in [Table 2](#). Also note that certain peripherals are assigned to particular pins, such the analog inputs.

 Only one peripheral signal can be multiplexed to a GPIO pin at a time. Some functions are restricted to certain pins due to additional internal circuitry required by the interface. These include: Trace signals, analog inputs, XTAL signals, USB signals, SWD interface, and reset. See [Table 3](#).

| Peripheral | Signal | Pin options |
|-------------------------------|---------------------|--------------------------------------|
| UART, I2C, SPI, I2S, PDM, PWM | All | P0.00-P0.31 |
| ADC, COMP, LPCOMP | All | P0.02-P0.05, P0.28-P0.31 (AIN0-AIN7) |
| Reset | RESET_N | P0.21 |
| SWD | SWD Clock SWD IO | SWCLK SWDIO |
| 32.768 kHz Crystal | XTAL1 XTAL2 | P0.00 P0.01 |
| NFCT | NFC1 NFC2 | P0.09 P0.10 |

Table 3: Peripheral pin options

3 Electrical specifications

Stressing the device above one or more of the ratings listed in the [Absolute maximum ratings](#) can cause permanent damage. These are stress ratings only. Operating the module at these or at any conditions other than those specified in the [Operating conditions](#) should be avoided. Exposure to absolute maximum rating conditions for extended periods may affect device reliability.

All given application information is only advisory and does not form part of the specification.

3.1 Absolute maximum ratings

| Symbol | Description | Min | Max | Unit |
|---------------------|------------------------------------|------|-----------|------|
| V _{CC_MAX} | Voltage on supply pin | -0.3 | 3.9 | V |
| V _{IO_MAX} | Voltage on GPIO pins (VCC > 3.6 V) | -0.3 | 3.9 | V |
| V _{IO_MAX} | Voltage on GPIO pins (VCC ≤ 3.6V) | -0.3 | VCC+0.3 V | V |
| T _S | Storage Temperature Range | -40 | 125 | °C |

Table 4: Absolute maximum ratings

The product is not protected against overvoltage or reversed voltages. If necessary, voltage spikes exceeding the power supply voltage specification, given in [Table 4](#), must be limited to values within the specified boundaries by using appropriate protection devices.

3.2 Operating conditions

Unless otherwise specified, all operating condition specifications are at an ambient temperature of 25 °C and a supply voltage of 3.0 V.

Operation beyond the specified operating conditions is not recommended and extended exposure beyond them may affect device reliability.

| Symbol | Parameter | Min | Typ. | Max | Unit |
|--------------------|-------------------------------------|-----|------|-----|------|
| V _{CC} | Operating supply voltage | 1.7 | 3.0 | 3.6 | V |
| T _{R_VCC} | Supply rise time (0 V to 1.7 V) | - | - | 60 | ms |
| T _A | Operating ambient Temperature range | -40 | 25 | 85 | °C |

Table 5: Operating conditions

3.3 General purpose I/O

The general purpose I/O is organized as one port enabling access and control of the 32 available GPIO pins through one port. Each GPIO can be accessed with the following user configurable features:

- Input/output direction
- Output drive strength
- Internal pull-up and pull-down resistors
- Wake-up from high- or low-level triggers on all pins
- Trigger interrupt on all pins
- All pins can be used by the PPI task/event system; the maximum number of pins that can be interfaced through the PPI at the same time is limited by the number of GPIOTE channels
- All pins can be individually configured to carry serial interface or quadrature demodulator signals

| Symbol | Parameter | Min | Typ. | Max | Unit |
|-----------------|----------------------|-----------|------|-----------|------|
| V _{IH} | Input high voltage | 0.7 x VCC | - | VCC | V |
| V _{IL} | Input low voltage | VSS | - | 0.3 x VCC | V |
| V _{OH} | Output high voltage | VCC - 0.4 | - | VCC | V |
| V _{OL} | Output low voltage | VSS | - | VSS + 0.4 | V |
| R _{PU} | Pull-up resistance | 11 | 13 | 16 | kΩ |
| R _{PD} | Pull-down resistance | 11 | 13 | 16 | kΩ |

Table 6: GPIO

3.4 Module reset

GPIO pin P0.21 may be used for a hardware reset. In order to utilize P0.21 as a hardware reset, the user information configuration registers, (UICR) PSELRESET[0] and PSELRESET[1], must both be set to the value of 0x7FFFFFFF15. When P0.21 is programmed as RESET, the internal pull-up is automatically enabled. Nordic Semiconductor example applications and development kits program P0.21 as **RESET_N**.

3.5 Debug and programming

The BMD-350 series supports the two pin Serial Wire Debug (SWD) interface and offers flexible and powerful mechanism for non-intrusive debugging of program code. Breakpoints, single stepping, and instruction trace capture of code execution flow are part of this support.

BMD-350 also supports ETM and ITM trace. Trace data from the ETM and the ITM is sent to an external debugger via a 4-bit wide parallel trace port. In addition to parallel trace, the TPIU supports serial trace via the Serial Wire Output (SWO) trace protocol.

3.6 Clocks

BMD-350 requires two clocks, a high frequency clock and a low frequency clock.

The high frequency clock is provided on-module by a high-accuracy 32 MHz crystal as required by the nRF52832 for radio operation.

The low frequency clock can be provided internally by an RC oscillator or synthesized from the fast clock, or externally by a 32.768 kHz crystal. An external crystal provides the lowest power consumption and greatest accuracy. Using the internal RC oscillator with calibration provides acceptable performance for Bluetooth low energy applications at a reduced cost and slight increase in power consumption.

 The ANT protocol requires the use of an external crystal.

3.6.1 32.768 kHz crystal (LFXO)

| Symbol | Parameter | Typ. | Max. | Unit |
|----------------------|---|--------|------|------|
| F_{NOM_LFXO} | Crystal frequency | 32.768 | - | kHz |
| $F_{TOL_LFXO_BLE}$ | Frequency tolerance, Bluetooth low energy applications ¹ | - | ±250 | ppm |
| $f_{TOL_LFXO_ANT}$ | Frequency Tolerance, ANT applications ¹ | - | ±50 | ppm |
| C_{L_LFXO} | Load capacitance | - | 12.5 | pF |
| C_{0_LFXO} | Shunt capacitance | - | 2 | pF |
| R_{S_LFXO} | Equivalent series resistance | - | 100 | kΩ |
| C_{pin} | Input capacitance on XL1 & XL2 pads | 4 | - | pF |

Table 7: 32.768 kHz crystal (LFXO)

3.6.2 32.768 kHz clock source comparison

| Symbol | Parameter | Min. | Typ. | Max. | Unit |
|----------------------|--|------|------|------|------|
| I_{LFXO} | Current for 32.768 kHz Crystal oscillator | - | 0.25 | - | μA |
| I_{LFRC} | Current for 32.768 kHz RC oscillator | - | 0.6 | 1 | μA |
| I_{LFSYNT} | Current for 32.768 kHz Synthesized oscillator | - | 100 | - | μA |
| $f_{TOL_LFXO_BLE}$ | Frequency Tolerance, 32.768 kHz Crystal oscillator (Bluetooth low energy Stack) ¹ | - | - | ±250 | ppm |
| $f_{TOL_LFXO_ANT}$ | Frequency Tolerance, 32.768 kHz Crystal oscillator (ANT Stack) ¹ | - | - | ±50 | ppm |
| f_{TOL_LFRC} | Frequency Tolerance, 32.768 kHz RC oscillator | - | - | ±2 | % |
| $f_{TOL_CAL_LFRC}$ | Frequency tolerance, 32.768 kHz RC after calibration | - | - | ±250 | ppm |
| f_{TOL_LFSYNT} | Frequency Tolerance, 32.768 kHz Synthesized oscillator | - | - | ±48 | ppm |

Table 8: 32.768 kHz clock source comparison

¹ $f_{TOL_LFXO_BLE}$ and $f_{TOL_LFXO_ANT}$ are the maximum allowed for Bluetooth low energy and ANT applications. Actual tolerance depends on the crystal used.

4 Firmware

u-blox recommends that projects for BMD-350 utilize nRF52832 tools and [Nordic Semiconductor's nRF5 SDK, DFU, and examples](#) for any new development. These resources give access to the very latest Bluetooth support from Nordic Semiconductor and provide an ongoing development path as new features are released.

 For legacy applications, source code is provided through our GitHub repositories for RigDFU, BMDware, Rigablue, developer tools, and mobile apps. The code allows customers to customize and extend their own development applications.

4.1 Factory image

The factory programmed firmware version is indicated on the label. Programming of the factory image is maintained solely for legacy applications. New development should use the latest [Nordic Semiconductor SDK and examples](#).

4.1.1 Firmware version “AA”

- RigDFU v3.2.0 (42)
- Nordic Semiconductor S132 SoftDevice v2.0.0
- BMDware v3.1.0 (50)
- Read-back protection enabled.

Modules can be programmed with customer code after a full-chip erase via the SWD interface.

 A full-chip erase will clear the assigned Public MAC address from memory. With Firmware Version AA and AB, the MAC address must be manually recovered.

4.1.2 Firmware version “AB”

- RigDFU v3.2.1 (43)
- Nordic Semiconductor S132 SoftDevice v2.0.0
- BMDware v3.1.1 (51)
- Read-back protection *enabled*.

Modules can be programmed with customer code after a full-chip erase via the SWD interface.

 A full-chip erase will clear the assigned Public MAC address from memory. With Firmware Version AA and AB, the MAC address must be manually recovered.

4.1.3 Firmware version “AC”

- RigDFU v3.2.2 (44)
- Nordic Semiconductor S132 SoftDevice v2.0.0
- BMDware v3.1.1 (51)
- Read-back protection *disabled*.

Modules can be programmed with customer code after a full-chip erase via the SWD interface.

 A full chip erase clears the assigned Public MAC address from memory; see [Bluetooth device address](#) on how to retain it.

4.1.4 Firmware version “AD”

- RigDFU v3.3.1 (46)
- Nordic Semiconductor S132 SoftDevice v3.1.0
- BMDware v3.2.1 (60)
- Read-back protection disabled.

Modules can be programmed with customer code after a full-chip erase via the SWD interface.

 A full chip erase clears the assigned Public MAC address from memory; see [Bluetooth device address](#) on how to retain it.

4.1.5 Firmware version “AE”

- RigDFU v3.4.0 (47)
- Nordic Semiconductor S132 SoftDevice v3.1.0
- BMDware v3.2.1 (60)
- Read-back protection disabled.

Modules can be programmed with customer code after a full-chip erase via the SWD interface.

 A full chip erase clears the assigned Public MAC address from memory; see [Bluetooth device address](#) on how to retain it.

 “AE” marked modules *may not* be loaded with previous factory firmware due to Nordic Semiconductor nRF52832 Errata #108. “AA” through “AD” marked modules may be loaded with any Factory Firmware version, including “AE”.

 Type number BMD-350-A-R-10 is loaded with firmware version “AE” only.

4.2 Module programming and read-back protection

For legacy applications, RigDFU allows for UART and OTA updates to RigDFU, the SoftDevice and application firmware.

In order to utilize the SWD port on “AA” and “AB” marked modules, the nRF52832 must be erased and recovered. Without this step, the module will not be recognized by most programmers. This is accomplished through *nrfjprog*, which is provided with the Nordic Semiconductor command line utilities:

```
nrfjprog -f nrf52 --recover
```

 A full chip erase is performed, so all components must be reloaded (Bootloader, SoftDevice and application firmware).

The BMD-350 module may be restored to the factory firmware versions noted above with the utilities available at our GitHub repositories.

4.3 SoftDevices

Nordic Semiconductor protocol stacks are known as SoftDevices. SoftDevices are pre-compiled, pre-linked binary files. SoftDevices can be programmed in nRF52 series SoCs and are downloadable from the Nordic Semiconductor website. The BMD-350 with the nRF52832 SoC supports the S132 (Bluetooth low energy Central and Peripheral), S212 (ANT) and S312 (ANT and Bluetooth low energy) SoftDevices.

4.3.1 S132

The S132 SoftDevice is a Bluetooth® low energy (LE) Central and Peripheral protocol stack solution supporting up to twenty connections with an additional Observer and a Broadcaster role all running concurrently. The S132 SoftDevice integrates a Bluetooth LE Controller and Host and provides a full and flexible API for building Bluetooth Smart nRF52 System on Chip (SoC) solutions.

4.3.2 S212

The S212 SoftDevice is an ANT™ protocol stack solution that provides a full and flexible Application Programming Interface (API) for building ANT System on Chip (SoC) solutions for the nRF52832 chip. The S212 SoftDevice simplifies combining the ANT protocol stack and an application on the same CPU. See the [ANT+ website](#) for membership in the ANT+ Alliance and S212 licensing.

4.3.3 S332

The S332 SoftDevice is a combined ANT and Bluetooth low energy protocol stack solution. It supports all four Bluetooth low energy roles (central, peripheral, observer, broadcaster) and ANT.

The S332 SoftDevice provides a full and flexible Application Programming Interface (API) for building concurrent ANT and Bluetooth low energy System on Chip (SoC) solutions. It simplifies combining an ANT and Bluetooth low energy protocol stack and an application on the same CPU, therefore eliminating the need for an added device to support concurrent multiprotocol. See the [ANT+ website](#) for membership in the ANT+ Alliance and S332 licensing.

4.4 Bluetooth device address

The BMD-350 module is preprogrammed from the factory with a unique public Bluetooth device (MAC) address stored in the CUSTOMER[0] and CUSTOMER[1] registers of the User Information Configuration Registers (UICR). The Bluetooth device address consists of the IEEE Organizationally Unique Identifier (OUI) combined with the six hexadecimal digits that are printed on a 2D barcode and in human-readable text on the module label, as described in [Module marking](#). The Bluetooth device address is stored in little endian format. The most significant bytes of the CUSTOMER[1] register are 0xFF to complete the 32-bit register.

| UICR Register | Address | Description | Remarks |
|---------------|------------|---------------------------|--|
| CUSTOMER[0] | 0x10001080 | Bluetooth_addr [0] (0xFF) | Example value. Actual value printed on label |
| CUSTOMER[0] | 0x10001081 | Bluetooth_addr [1] (0xEE) | Example value. Actual value printed on label |
| CUSTOMER[0] | 0x10001082 | Bluetooth_addr [2] (0xDD) | Example value. Actual value printed on label |
| CUSTOMER[0] | 0x10001083 | Bluetooth_addr [3] (0xCC) | IEEE OUI ^{2,3} |
| CUSTOMER[1] | 0x10001084 | Bluetooth_addr [4] (0xBB) | IEEE OUI ^{2,3} |
| CUSTOMER[1] | 0x10001085 | Bluetooth_addr [5] (0xAA) | IEEE OUI ^{2,3} |
| CUSTOMER[1] | 0x10001086 | 0xFF | Unused |
| CUSTOMER[1] | 0x10001087 | 0xFF | Unused |

Table 9: Bluetooth device address

² The IEEE OUI is 94:54:93 for type number BMD-350-A-R-00. The full Bluetooth device address is stored in the UICR.

³ Type number BMD-350-A-R-10 encodes the full Bluetooth device address in the label data matrix and is stored in the UICR.

5 Mechanical specifications

5.1 Dimensions

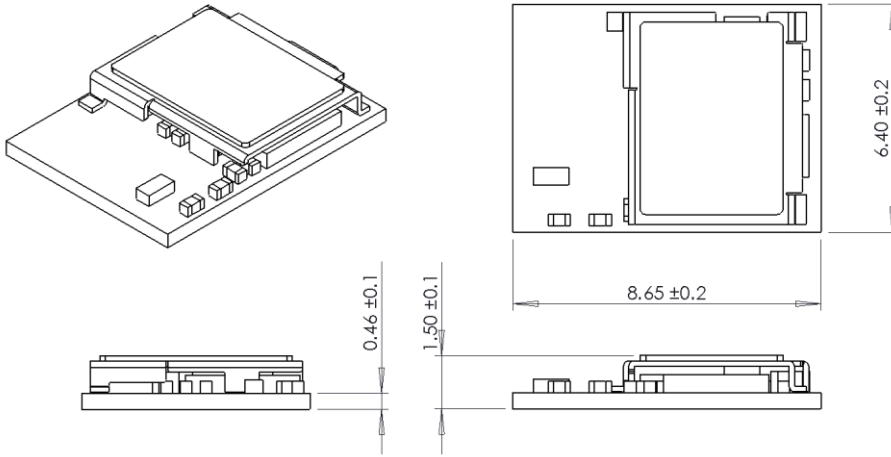

All dimensions in mm

Figure 3: BMD-350 mechanical drawing

5.2 Recommended PCB land pads

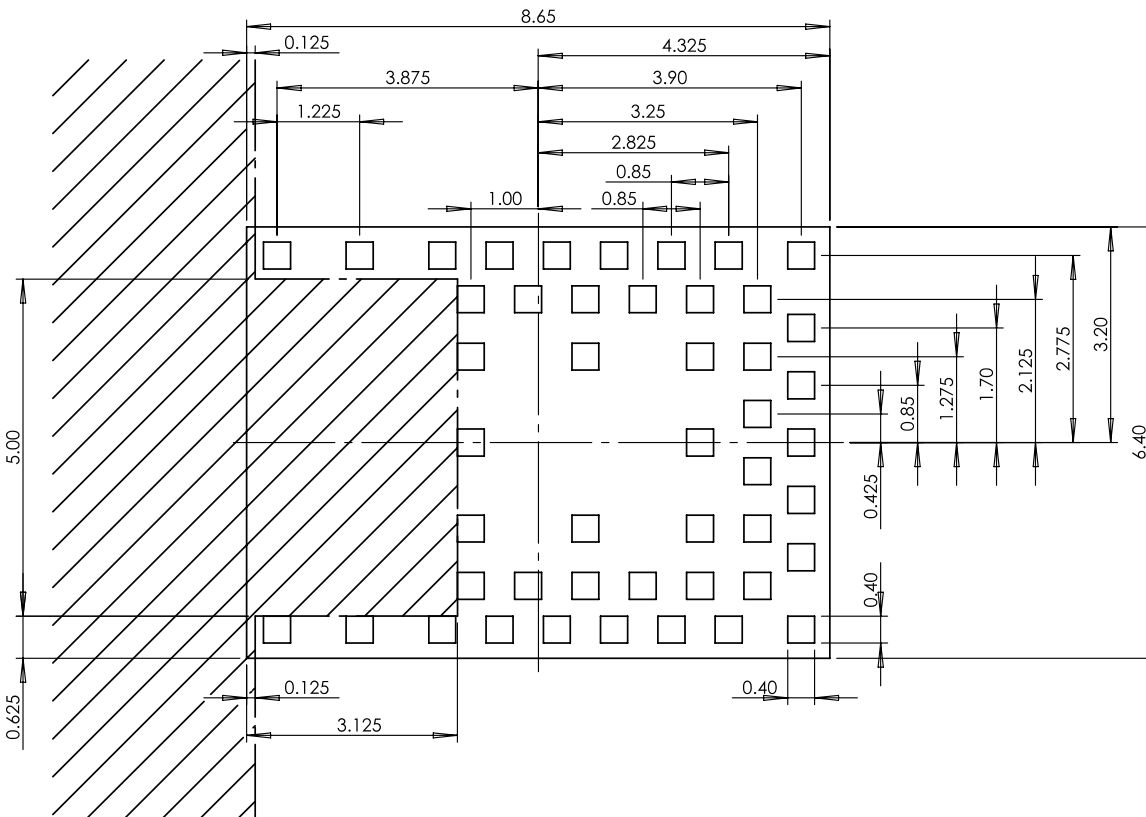

All dimensions in mm

Figure 4: Recommended PCB land pads

5.3 Module marking

5.3.1 Module marking for type number BMD-350-A-R-00

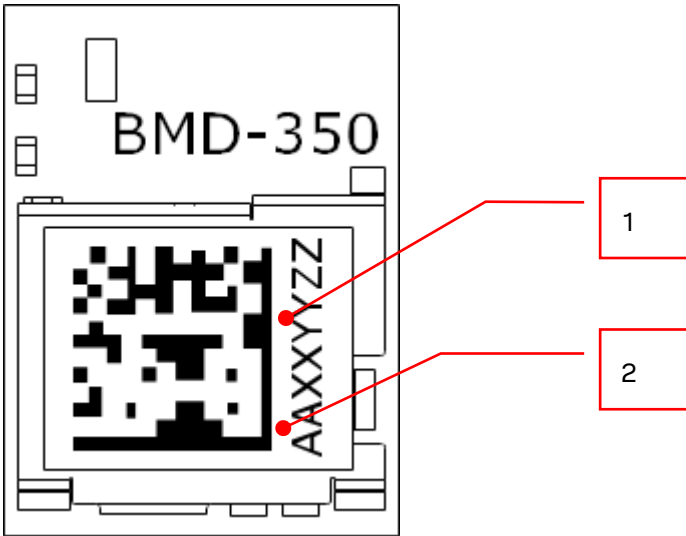

Figure 5: Module marking for type number BMD-350-A-R-00

| Reference | Description |
|-----------|--|
| 1 | Data Matrix with unique serial number of six alphanumeric symbols, also in human-readable form. The full Bluetooth address consists of the IEEE OUI (94:54:93) with the six symbols appended: Example value: 94:54:93:XX:YY:ZZ |
| 2 | First two characters indicate firmware version (AA, AB, AC, AD, or AE) |

Table 10: Module marking for type number BMD-350-A-R-00

5.3.2 Module marking for type number BMD-350-A-R-10

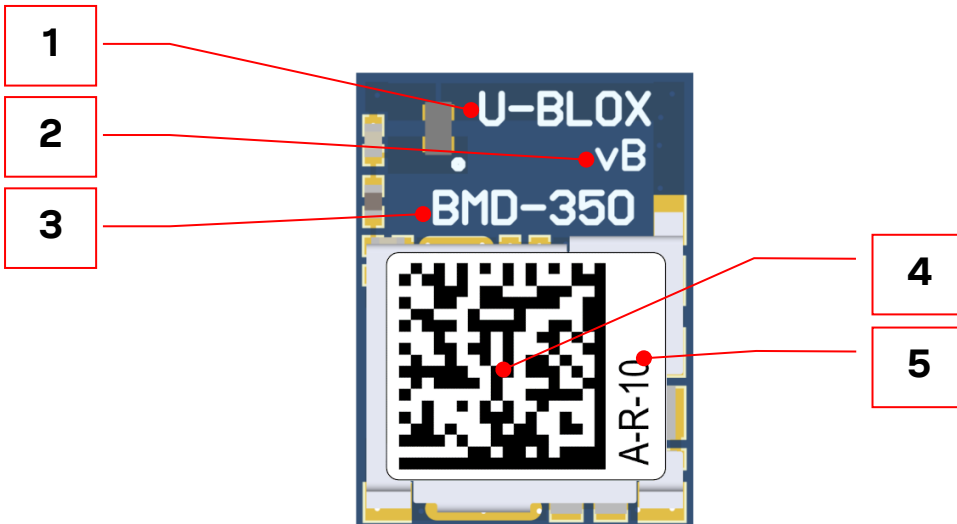

Figure 6: Module marking for type number BMD-350-A-R-10

| Reference | Description |
|-----------|---|
| 1 | “U-BLOX” imprinted on silkscreen |
| 2 | PCB revision |
| 3 | Product name (Model) |
| 4 | Data Matrix with unique serial number of 19 alphanumeric symbols. The first 3 symbols represent module type number unique to each module variant, the next 12 symbols represent the unique hexadecimal Bluetooth device address of the module AABBCCDDEEFF, and the last 4 symbols represent the hardware and firmware version encoded HHFF. Factory firmware version “AE” is encoded as “01” in the data matrix. |
| 3+5 | Product type number |

Table 11: Module marking for type number BMD-350-A-R-10

6 RF design notes

6.1 Recommended RF layout and ground plane

For the BMD-350, the integrated antenna requires a suitable ground plane to radiate effectively.

The area under and extending out from the antenna portion of the module should be kept clear of copper and other metal on all layers. The module should be placed at the edge of the PCB with the antenna edge facing out. Reducing the ground plane from that shown in [Figure 7](#) will reduce the effective radiated power.

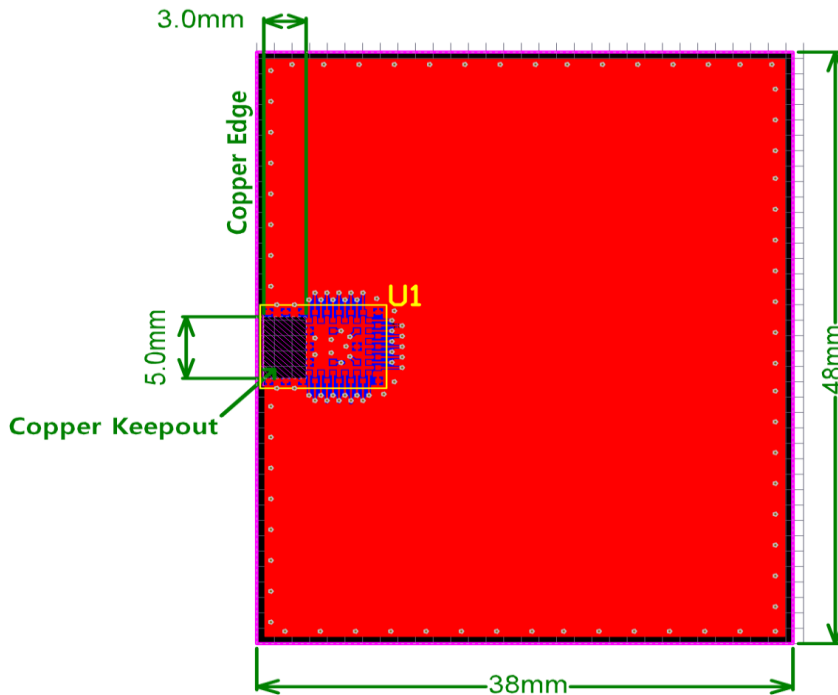

Figure 7: Recommended RF layout and ground plane

6.2 Mechanical enclosure

Care should be taken when designing and placing the BMD-350 into an enclosure. Metal should be kept clear from the antenna area, both above and below. Any metal around the module can negatively impact RF performance.

The module is designed and tuned for the antenna and RF components to be in free air. Any potting, epoxy fill, plastic over-molding, or conformal coating can negatively impact RF performance and must be evaluated by the customer.

6.3 Antenna patterns

Antenna patterns are based on the BMD-350 Evaluation Kit with a ground plane size of 82 mm x 56 mm. The X-Y-Z orientation is shown in [Figure 8](#).

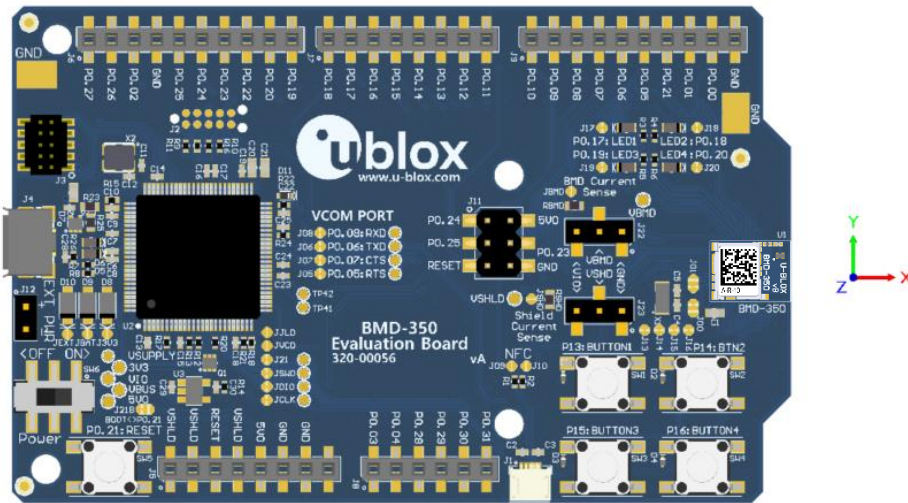

Figure 8: BMD-350 Evaluation kit X-Y-Z orientation

6.3.1 X-Y plane

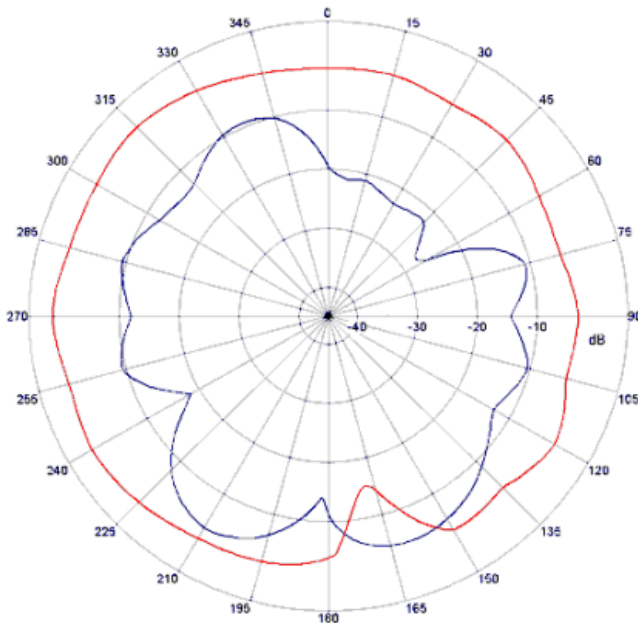

Figure 9: X-Y plane antenna pattern

6.3.2 X-Z plane

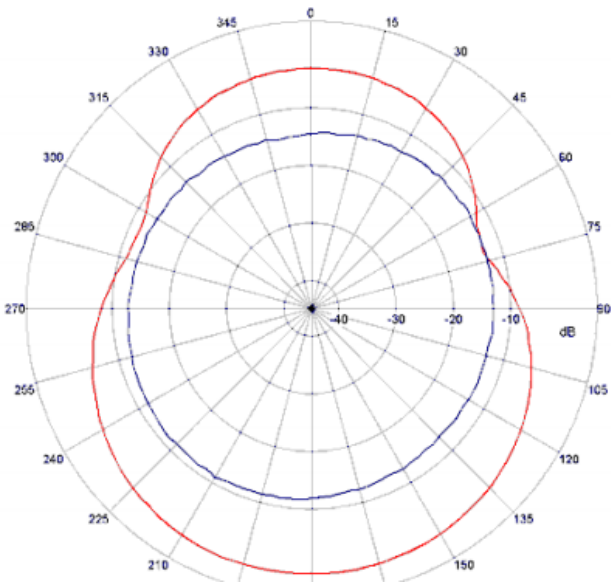

Figure 10: X-Z plane antenna pattern

6.3.3 Y-Z plane

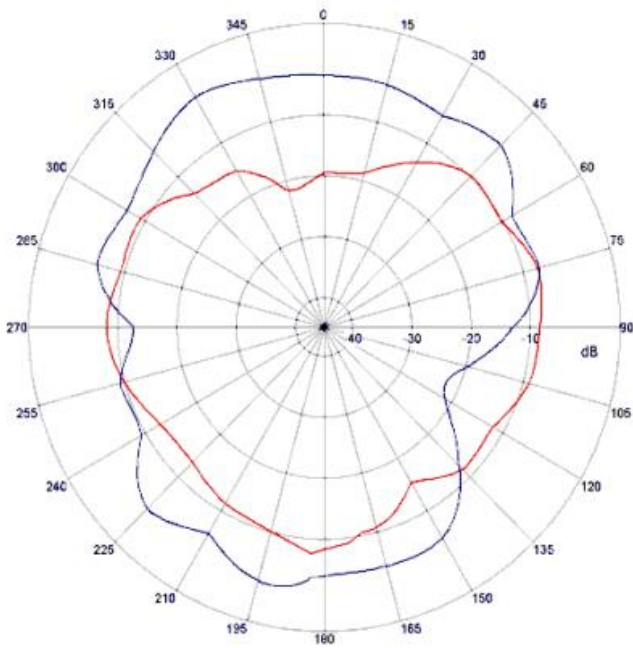

Figure 11: Y-Z plane antenna pattern

7 BMD-350 evaluation development kit



BMD-350 is a full featured evaluation board that provides a complete I/O pin out to headers, on-board programming and debugging, 32.768 kHz crystal, power and virtual COM port over USB, four user LEDs, and four user buttons. The evaluation boards is optionally powered from a CR2032 coin cell battery and includes current sense resistors and headers for convenient current measurements. An Arduino Uno R3 style header is provided for easy prototyping of additional functions. The evaluation boards also support programming off-board BMD-3 series, ANNA-B1, and NINA-B1/B3/B4 series modules.

8 Qualification and approvals

8.1 United States (FCC)

BMD-350 has received Federal Communications Commission (FCC) CFR47 Telecommunications, Part 15 Subpart C “Intentional Radiators” modular approval in accordance with Part 15.247 Modular Transmitter approval. The modular approval allows the end user to integrate the module into a finished product without obtaining subsequent and separate FCC approvals for intentional radiation, provided no changes or modifications are made to the module circuitry. Changes or modifications could void the user’s authority to operate the equipment. The end user must comply with all of the instructions provided by the Grantee, which indicate installation and/or operating conditions necessary for compliance.

The finished product is required to comply with all applicable FCC equipment authorizations regulations, requirements and equipment functions not associated with the transmitter module portion. For example, compliance must be demonstrated to regulations for other transmitter components within the host product; to requirements for unintentional radiators (Part 15 Subpart B “Unintentional Radiators”), such as digital devices, computer peripherals, radio receivers, etc.; and to additional authorization requirements for the non-transmitter functions on the transmitter module (i.e., Verification, or Declaration of Conformity) (e.g., transmitter modules may also contain digital logic functions) as appropriate.

-  Modification to this product will void the users’ authority to operate this equipment.
-  The OEM is still responsible for verifying end product compliance with FCC Part 15, subpart B limits for unintentional radiators through an accredited test facility.

8.1.1 Labeling and user information requirements

The BMD-350 is assigned the FCC ID number: 2AA9B05

If the FCC ID is not visible when the module is installed inside another device, then the outside of the finished product into which the module is installed must also display a label referring to the enclosed module. This exterior label can use the following or similar wording:

Contains FCC ID: 2AA9B05

In addition to marking the product with the appropriate FCC ID, the end product user manual may also require specific information based on the digital device classification. Refer to the [FCC Rules, Title 47, Subchapter A, Part 15, Subpart B, Chapter §15.105](#) for specific wording of the notices.

8.1.2 RF exposure

All transmitters regulated by FCC must comply with RF exposure requirements. [KDB 447498 General RF Exposure Guidance](#) provides guidance in determining whether proposed or existing transmitting facilities, operations or devices comply with limits for human exposure to Radio Frequency (RF) fields adopted by the Federal Communications Commission (FCC).

This module is approved for installation into mobile and/or portable host platforms and must not be co-located or operating in conjunction with any other antenna or transmitter except in accordance with FCC multi-transmitter guidelines. End users must be provided with transmitter operating conditions for satisfying RF Exposure compliance.

8.2 Canada (ISED)

BMD-350 module is certified for use in Canada under Innovation, Science and Economic Development Canada (ISED) Radio Standards Specification (RSS) RSS-247 and RSSGen.

8.2.1 Labeling and user information requirements

BMD-350 is assigned the IC ID number: 12208A-05

Labeling Requirements for the Host Device (from Section 3.2.1, RSS-Gen, Issue 3, December 2010): The host device shall be properly labeled to identify the module within the host device. The Industry Canada certification label of a module shall be clearly visible at all times when installed in the host device, otherwise the host device must be labeled to display the Industry Canada certification number of the module, preceded by the words “Contains transmitter module”, or the word “Contains”, or similar wording expressing the same meaning, as follows:

Contains transmitter module IC: 12208A-05

User Manual Notice for License-Exempt Radio Apparatus (from Section 7.1.3 RSS-Gen, Issue 3, December 2010): User manuals for license-exempt radio apparatus shall contain the following or equivalent notice in a conspicuous location in the user manual or alternatively on the device or both:

This device complies with Industry Canada license exempt RSS standard(s). Operation is subject to the following two conditions: (1) this device may not cause interference, and (2) this device must accept any interference, including interference that may cause undesired operation of the device.

Le présent appareil est conforme aux CNR d'Industrie Canada applicables aux appareils radio exempts de licence. L'exploitation est autorisée aux deux conditions suivantes: (1) l'appareil ne doit pas produire de brouillage, et (2) l'utilisateur de l'appareil doit accepter tout brouillage radioélectrique subi, même si le brouillage est susceptible d'en compromettre le fonctionnement.

Transmitter Antenna (from Section 7.1.2 RSS-Gen, Issue 3, December 2010): User manuals for transmitters shall display the following notice in a conspicuous location:

Under Industry Canada regulations, this radio transmitter may only operate using an antenna of a type and maximum (or lesser) gain approved for the transmitter by Industry Canada. To reduce potential radio interference to other users, the antenna type and its gain should be so chosen that the equivalent isotropically radiated power (e.i.r.p.) is not more than that necessary for successful communication.

Conformément à la réglementation d'Industrie Canada, le présent émetteur radio peut fonctionner avec une antenne d'un type et d'un gain maximal (ou inférieur) approuvé pour l'émetteur par Industrie Canada. Dans le but de réduire les risques de brouillage radioélectrique à l'intention des autres utilisateurs, il faut choisir le type d'antenne et son gain de sorte que la puissance isotrope rayonnée équivalente (p.i.r.e.) ne dépasse pas l'intensité nécessaire à l'établissement d'une communication satisfaisante.

8.2.2 RF exposure

All transmitters regulated by IC must comply with RF exposure requirements listed in RSS-102 - Radio Frequency (RF) Exposure Compliance of Radiocommunication Apparatus (All Frequency Bands). This module is approved for installation into mobile and/or portable host platforms and must not be co-located or operating in conjunction with any other antenna or transmitter except in accordance with Industry Canada's multi-transmitter guidelines. End users must be provided with transmitter operating conditions for satisfying RF Exposure compliance.

8.3 European Union regulatory compliance

Information about regulatory compliance of the European Union for the BMD-350 module is available in the BMD-350 Declaration of Conformity.

8.3.1 Radio Equipment Directive (RED) 2014/53/EU

BMD-350 complies with the essential requirements and other relevant provisions of Radio Equipment Directive (RED) 2014/53/EU.

8.3.2 Labeling and user information requirements

The label on the final products which contain the BMD-350 module must follow CE marking requirements. The “R&TTE Compliance Association Technical Guidance Note 01” provides guidance on final product CE marking.

8.4 Japan (MIC)

BMD-350 has received type certification and is labeled with its own technical conformity mark and certification number as required to conform to the technical standards regulated by the Ministry of Internal Affairs and Communications (MIC) of Japan pursuant to the Radio Act of Japan. Integration of this module into a final end product does not require additional radio certification provided installation instructions are followed and no modifications of the module are allowed. Additional testing may be required:

- If the host product is subject to electrical appliance safety (for example, powered from an AC mains), the host product may require Product Safety Electrical Appliance and Material (PSE) testing. The integrator should contact their conformance laboratory to determine if this testing is required.
- There is a voluntary Electromagnetic Compatibility (EMC) test for the host product administered by VCCI: http://www.vcci.jp/vcci_e/index.html

The label on the end product which contains a BMD-350 module must follow the MIC marking requirements. Labeling requirements for Japan available at the Ministry of Internal Affairs and Communications (MIC) website: <http://www.tele.soumu.go.jp/e/index.htm>.

The BMD-350 module is labeled with its assigned technical conformity mark and certification number. The end product in which this module is being used must have an external label referring to the type certified module inside:

Contains transmitter module with certificate number:

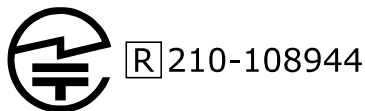

8.5 Australia / New Zealand (RCM)

BMD-350 has been tested to comply with the AS/NZS 4268:2017, Radio equipment and systems – Short range devices – Limits and methods of measurement. The report may be obtained from your local FAE and may be used as evidence in obtaining permission to use the Regulatory Compliance Mark (RCM).

Information on registration as a Responsible Party, license and labeling requirements may be found at the following websites:

Australia: <http://www.acma.gov.au/theACMA/radiocommunications-short-range-devices-standard-2004>

New Zealand: <http://www.rsm.govt.nz/compliance>

Only Australian-based and New Zealand-based companies who are registered may be granted permission to use the RCM. An Australian-based or New Zealand-based agent or importer may also register as a Responsible Party to use the RCM on behalf of a company not in Australia or New Zealand.

8.6 South Korea (KCC)

The BMD-350 is certified under Clause 2, Article 58-2 of the Radio Waves Act.

When a product containing the BMD-350 is placed on the South Korean market, the product must be affixed with a label or marking containing the KCC logo and certification number as shown in the following figure. This information must also be included in the product user manuals.

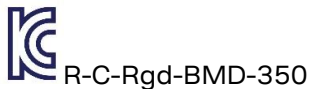

The height of the KCC logo must be at least 5 mm.

8.7 Brazil (ANATEL)

BMD-350 is evaluated according to: Resolution 680 of 27/06/2017, Act 14448 of 04/12/2017, Certificate number: 00857-21-05903.

The end products that contain these modules must list the ANATEL number from the modular approval. The number can go on the end product label, manual, box or software, with the following phrase:

Contains ANATEL approved module # 00857-21-05903

8.8 Eurasia (EAC)

BMD-350 is certified in Eurasia (EAC) with the following number:

EAЭC N RU Д-US.HA27.B.00650/18

The image of the unified product turnover sign EAC is a combination of three stylized letters E, A, and C graphically shown using straight angles and having the same length and width as well as precise square proportion against the light of contrasting background. Two versions are shown here:



Marking Application Procedure and Rules:

- The dimensions of the EAC marks are determined by the manufacturer (supplier) authorized to use it.
- The basic size is at least 5 mm.
- Dimensions of the unified turnover sign must guarantee that its elements are accurate and visible with unaided eye against the common color background of the object.
- If unable to indicate on product, must be added to accompanying document.

8.9 Mexico (IFETEL)

The end products that contain these modules must list the IFETEL number from the modular approval. The number can go on the end product label, manual, box or software, with the following phrase:

Este equipo contiene el módulo BMD-350 con Número IFETEL: RCPRIBM18-1491

- or -

Este equipo contiene el módulo con IFT #: RCPRIBM18-1491

8.10 China (SRRC)

BMD-350 has received certification of conformity in accordance with the China MIIT Notice 2014-01 of State Radio Regulation Committee (SRRC) certification scheme. Integration of this module into a final product does not require additional radio certification, provided installation instructions are followed and no modifications of the module are allowed. The BMD-350 is marked with the following ID:

CMIIT ID: 2018DJ7255

8.11 Bluetooth qualification

The Bluetooth SIG maintains the Bluetooth specification and ensures that products are properly tested and comply with the Bluetooth license agreements. Companies that list products with the Bluetooth SIG are required to be members of the SIG and submit the listed fees. Refer to this link for details: <https://www.bluetooth.com/develop-with-bluetooth/qualification-listing>

The BMD-350 Bluetooth Low Energy module based on the Nordic Semiconductor nRF52832 is listed as a “Tested Component”, with Qualified Design ID 101018. This allows an end-product based on a BMD-350 module to inherit the component listings without the need to run through all of the tests again. The end-product will often inherit several QDIDs, and are identified on a “Declaration of Compliance”.

The BMD-350 primarily utilizes the 132 SoftDevice.

9 Environmental

9.1 RoHS

BMD-350 is in compliance with Directive 2011/65/EU, 2015/863/EU of the European Parliament and the Council on the restriction of the use of certain hazardous substances in electrical and electronic equipment. The RoHS declaration is available in the BMD-350 EU Declaration of Conformity [2].

9.2 REACH

BMD-350 does not contain the [SVHC \(Substance of Very High Concern\)](#), as defined by Directive EC/1907/2006 Article according to REACH Annex XVII.

9.3 California proposition 65 (P65)

This product can expose you to Nickel (metallic), which is known to the State of California to cause cancer. For more information go to www.P65Warnings.ca.gov.



Warnings are not required where the listed chemical is inaccessible to the average user of the end product.

10 Product handling

10.1 Packaging

10.1.1 Reel packaging for type number BMD-350-A-R-00

Modules are packaged on 330 mm reels loaded with 1000 modules. Each reel is placed in an antistatic bag with a desiccant pack and humidity card and placed in a 340x350x65 mm box. An antistatic warning and reel label are adhered to the outside of the bag.

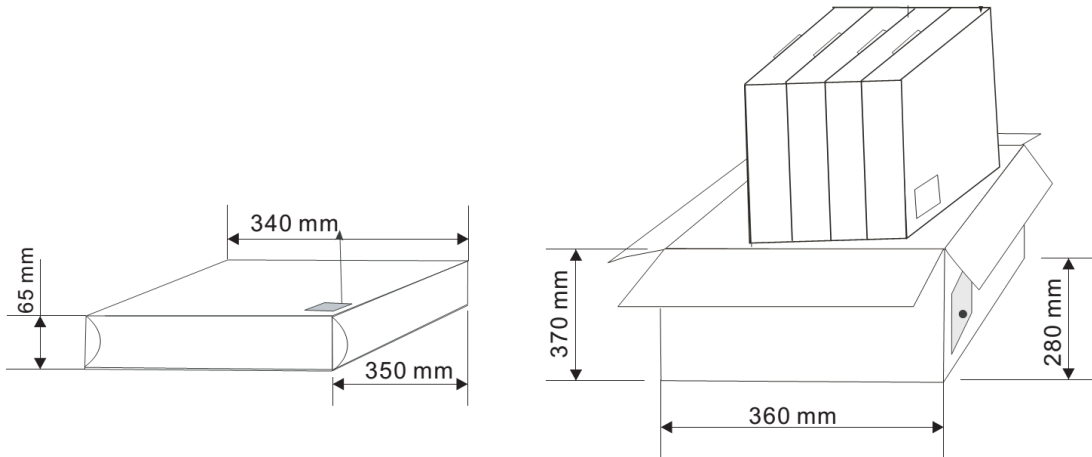
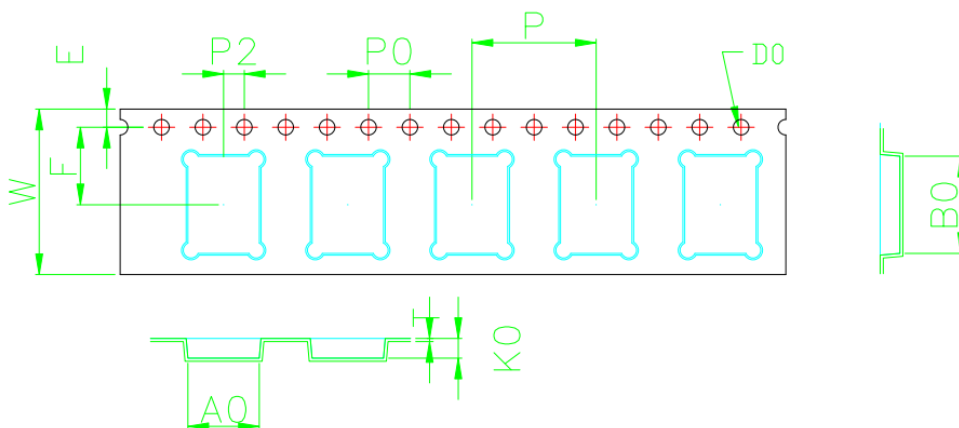

Figure 12 – Reel cartons

10.1.2 Reel packaging for type number BMD-350-A-R-10

Modules are packaged on 330 mm reels loaded with 1000 modules. Each reel is placed in an antistatic bag with a desiccant pack and humidity card and placed in a 370x355x56 mm box. See the u-blox Package Information Guide [1] for full specifications on reel dimensions, box sizes and shipping label content. BMD-350-A-R-10 modules use u-blox reel type A2.

10.1.3 Carrier tape dimensions for type number BMD-350-A-R-00



| | | | | | | | |
|---|------------|----|------------|----|-----------|----|-----------|
| W | 16.00±0.30 | P | 12.00±0.10 | A0 | 6.90±0.10 | B0 | 9.40±0.10 |
| S | 0.00±0.10 | P0 | 4.00±0.10 | A1 | | B1 | |
| E | 1.75±0.10 | P2 | 2.00±0.10 | | | B2 | |
| F | 7.50±0.10 | D0 | ∅1.50±0.10 | K0 | 1.90±0.10 | K1 | |
| T | 0.30±0.05 | D1 | | | | | |

Figure 13: Carrier tape dimensions for type number BMD-350-A-R-00

10.1.4 Carrier tape dimensions for type number BMD-350-A-R-10

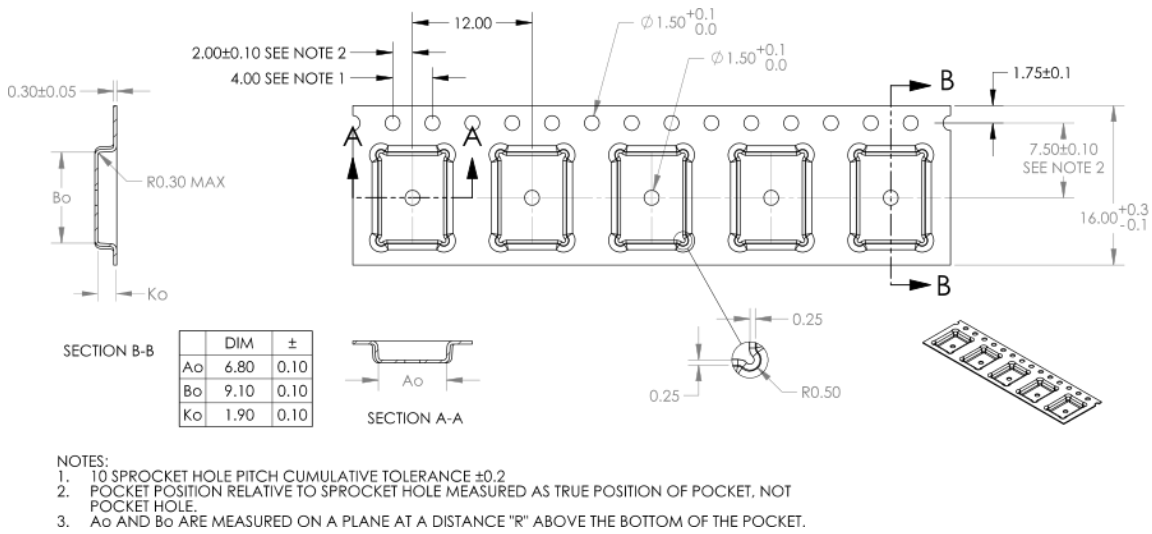

Figure 14: Carrier tape dimensions for type number BMD-350-A-R-10

10.2 Carrier tape orientation

BMD-350 modules are positioned in the carrier tape with the antenna oriented toward the sprocket holes. See Figure 15.

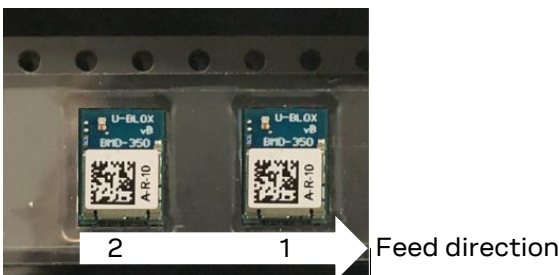

Figure 15: Carrier tape orientation

“Feed direction” is defined in such a way that at the customer’s assembly line a module is first picked at position “1” and then at position “2”.

10.3 Moisture sensitivity level

The BMD-350 is rated for MSL 3, 168-hour floor life after opening.

10.4 Reflow soldering

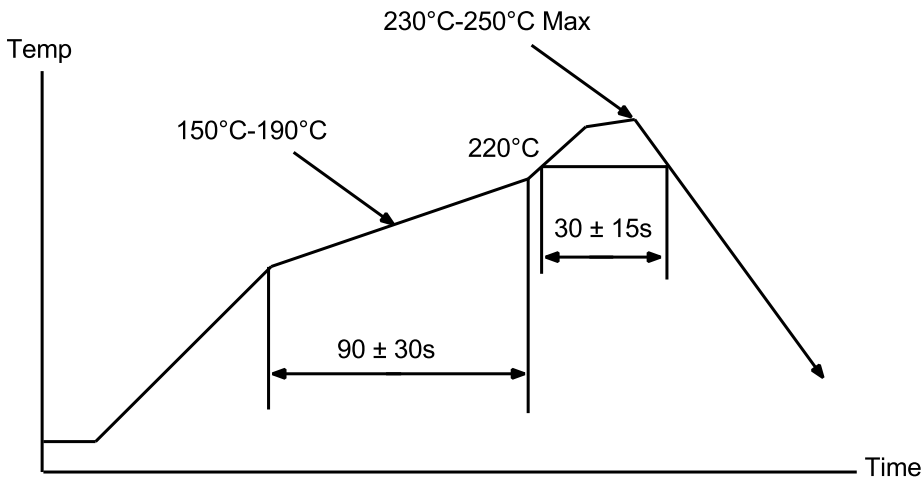

Figure 16: Reflow profile for lead free solder

10.5 ESD precautions

- ⚠ BMD-350 contains highly sensitive electronic circuitry and is an Electrostatic Sensitive Device (ESD). Handling the BMD-350 module without proper ESD protection may destroy or damage them permanently.

Proper ESD handling and packaging procedures must be applied throughout the processing, handling and operation of any application that incorporates the BMD-350 module. Failure to observe these recommendations can result in severe damage to the device.

11 Ordering information

| Ordering Code | Product |
|---------------|--|
| BMD-350-A-R | BMD-350 module, Rev A, Tape and Reel, 1000-piece multiples |
| BMD-350-Eval | BMD-350 Evaluation Kit w/ SEGGER J-Link-OB debug probe |

Table 12: Product ordering codes

12 Life support and high-risk use warnings

This product is not designed nor intended for use in a life support device or system, nor for use in other fault-intolerant, hazardous, or other environments requiring fail-safe performance, such as any application in which the failure or malfunction of the product could lead directly or indirectly to death, bodily injury, or physical or property damage (collectively, “High-Risk Environments”).

-  u-blox expressly disclaims any express or implied warranty of fitness for use in high-risk environments.

The customer using this product in a High-Risk Environment agrees to indemnify and defend u-blox from and against any claims and damages arising out of such use.

Related documents

- [1] u-blox package information guide, [UBX-14001652](#)
- [2] u-blox BMD-350 EU Declaration of Conformity, [UBX-20002678](#)
- [3] Nordic Semiconductor, [nRF52832 Product Specification](#)
- [4] Nordic Semiconductor, [nRF5 Software Development Kit](#)

 For product change notifications and regular updates of u-blox documentation, register on our website, www.u-blox.com.

Revision history

| Revision | Date | Name | Comments |
|----------|-------------|------|---|
| 0.8 | 06-Nov-2015 | | Initial preliminary release. |
| 0.8.1 | 10-Nov-2015 | | Updated Table 5, Figure 5, Section 7.5. Corrected antenna references. |
| 0.8.2 | 11-Nov-2015 | | Updated Figure 1. |
| 0.8.3 | 20-Nov-2015 | | Updated current ratings from nRF52832 OPC v0.6.3. Corrected Table 3. |
| 0.9 | 17-Mar-2016 | | Added BMD-301, GPIO notes, MSL, updated certifications, updated electrical specifications |
| 0.9.4 | 23-Mar-2016 | | Added BMD-301 antennas |
| 1.0 | 04-May-2016 | | Production Release; removed pending for FCC, Japan (MIC), & Bluetooth |
| 1.1 | 20-May-2016 | | Removed pending for IC, MIC (BMD-301) |
| 1.2 | 03-Jun-2016 | | Added Factory Firmware Version AB information |
| 1.3 | 06-Jun-2016 | | Updated Module Programming and Read-Back Protection section |
| 1.4 | 07-Jul-2016 | | Added preliminary information for the BMD-350 |
| 1.5 | 28-Jul-2016 | | Added RigDFU and BMDware pin numbers, corrected nRF52832 PS link |
| 1.6 | 10-Aug-2016 | | Corrected RESET pin number on BMD-350 |
| 1.7 | 10-Nov-2016 | | Updated layout drawings, added more BMD-350 data + certs |
| 1.8 | 02-Dec-2016 | | Added BMD-350 Japan certificate number |
| 1.9 | 10-Aug-2017 | | Add RED for BMD-300, BMD-301, BMD-350; Bluetooth DID for BMD-350, Factory Firmware AD |
| 1.10 | 29-Sep-2017 | | Added Bluetooth 5 QDIDs, Factory Firmware AE |
| 1.11 | 17-Apr-2018 | | Added antenna gain in section 5 |
| 1.2 | 08-Oct-2018 | | Added BMDware, RigDFU, Rigablue notice in Section 8. Removed BMDware and RigDFU pin-out sections 6.3 and 6.4. Called out BMD-300/301/350 in title rather than "Series" |
| 2.0 | 22-Jan-2019 | | Updated to new format BMD-300, BMD-301, and BMD-350 are now in separate datasheets Updated Life Support and other High-Risk Use Warning |
| 2.1 | 11-Feb-2019 | | Corrected Figure 5 – Recommended PCB Land Pads. Added Bluetooth Mesh to Features and Quick Specifications. Updated links to Nordic Semiconductor web information. |
| R22 | 10-Jan-2020 | brec | Document converted from Rigado to u-blox BMD-350 data sheet. |
| R23 | 03-Mar-2020 | brec | Added type number BMD-350-A-R-10; Added label information for new type number in section 5.3; Added ESD precautions in section 10.5; Changed images to be u-blox branded; Added packaging specification for type number BMD-350-A-R-10 in section 10.1. |
| R24 | 31-Mar-2020 | brec | Updated product photo |
| R25 | 03-Feb-2021 | brec | Corrected dimension rounding errors in chapters 1 and 5. |
| R26 | 22-Mar-2021 | brec | Updated ANATEL certificate number |
| R27 | 28-Oct-2021 | brec | Added reference to existing South Korea (KCC) certification |
| R28 | 16-May-2022 | brec | Included KCC certification info in Table 1 . Updated product status for type number BMD-350-A-R-00 to Obsolete. Added Carrier tape orientation information . Removed ambiguous description of operating condition ranges in Electrical specifications . |

Contact

For further support and contact information, visit us at www.u-blox.com/support.