

Subject to changes. Please also observe the further product documentation!

WAGO GmbH & Co. KG  
 Hansastr. 27  
 32423 Minden  
 Phone: +49571 887-0 | Fax: +49571 887-169  
 Email: [info.de@wago.com](mailto:info.de@wago.com) | Web: [www.wago.com](http://www.wago.com)

Do you have any questions about our products?  
 We are always happy to take your call at +49 (571) 887-44222.

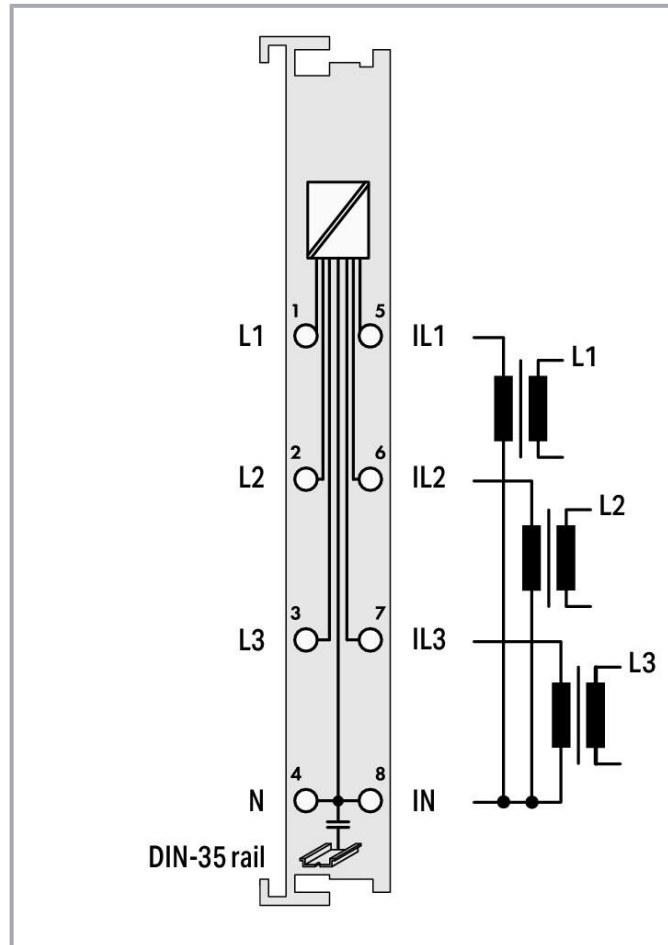
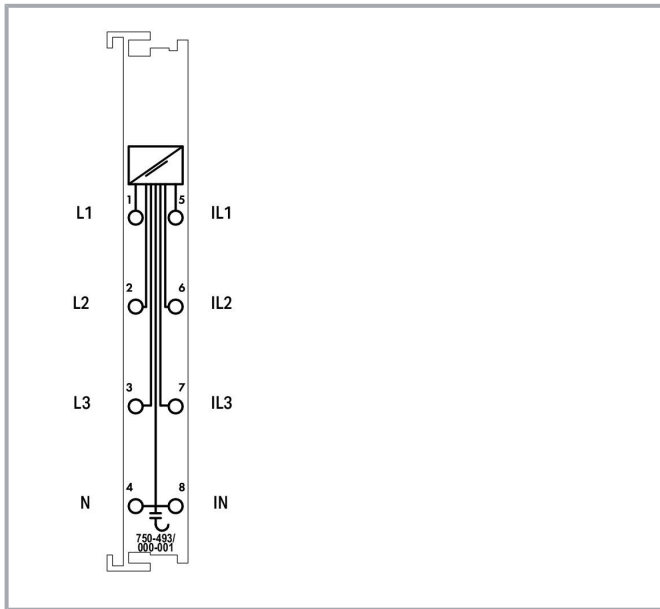

## Item description

The 3-phase power measurement module measures electrical data in a three-phase supply network.

The voltage is measured via network connection to clamping points L1, L2, L3 and N.

The current of the three phases is fed to IL1, IL2, IL3, and IN via current transformers.

The 3-phase power measurement module transmits the root mean square values into the process image without requiring high computing power from the controller. For each phase, the effective power (P) and the energy consumption (W) are calculated by the 3-phase power measurement module using the root mean square values for all measured voltages (V) and currents (I). For example, both the apparent power (S) and phase shift angle ( $\varphi$ ) can be easily derived from these values.

Therefore, the 3-phase power measurement module provides comprehensive network analysis via fieldbus. Metrics, such as effective and apparent power consumption or load condition, enable the operator to optimize supply to a drive or machine. This can protect the installation from damage and failure.

Subject to changes. Please also observe the further product documentation!

## Data

### Technical data

Number of measurement inputs	6 (3 voltage measurement inputs, 3 current measurement inputs)
Signal type	Power measurement
Signal form	Any (taking the maximum frequency into account)
Resolution [bit]	16 bits
Data width	2 x 48-bit data; 2 x 24-bit control/status (optional)
Voltage path input resistance (typ.)	1071 k $\Omega$
Current path input resistance (typ.)	5 m $\Omega$
Reference for measurement error	AC current/voltage
Measurement error (reference temperature)	25 °C
Measurement error, deviation (max.) from the upper-range value	0.5 %
Measurement current (max.)	5 A
Measurement voltage (max.)	500 VAC, 3 phases
Measurement cycle time	Adjustable measuring cycle time for Min_Max_Values
Frequency range with activated DC filter	10 ... 2000 Hz
Frequency range with deactivated DC filter	0 ... 2000 Hz
Frequency range (mains frequency)	45 ... 65 Hz
Limit frequency	7.2 kHz
Rated voltage	$U_{LN} = 277$ VAC/DC; $U_{LL} = 480$ VAC
Calculated values	Active power, active energy, grid frequency, $\cos \varphi$
Measurement components	Evaluating
Measurement method	True RMS measurement
Configuration options	WAGO-I/O-CHECK CODESYS Library <i>e!COCKPIT</i>
Supply voltage (system)	5 VDC; via data contacts
Current consumption (5 V system supply)	100 mA
Isolation	4 kV system/field
Rated surge voltage	4 kV
Indicators	LED (A) green: Communication; LED (B-G) red: Error L1, Display: Override in current measurement path, Display: Undervoltage in voltage measurement path, Error L2, Error L3, Display: Override in voltage measurement path; LED (H) yellow: Interchange in phase sequence L1-L2-L3

Subject to changes. Please also observe the further product documentation!

## Connection data

Connection technology: inputs/outputs	8 x CAGE CLAMP®
Connection type 1	Inputs/Outputs
Solid conductor	0.08 ... 2.5 mm <sup>2</sup> / 28 ... 14 AWG
Fine-stranded conductor	0.08 ... 2.5 mm <sup>2</sup> / 28 ... 14 AWG
Strip length	8 ... 9 mm / 0.31 ... 0.35 inches

## Physical data

Width	12 mm / 0.472 inches
Height	100 mm / 3.937 inches
Depth	67.8 mm / 2.669 inches
Depth from upper-edge of DIN-rail	60.6 mm / 2.386 inches

## Mechanical Data

Mounting type	DIN-35 rail
---------------	-------------

## Material Data

Color	light gray
Housing material	Polycarbonate; polyamide 6.6
Fire load	0.955 MJ
Weight	48 g
Conformity marking	CE

## Environmental requirements

Ambient temperature (operation)	0 ... +55 °C
Ambient temperature (storage)	-25 ... +85 °C
Protection type	IP20
Pollution degree	2 per IEC 61131-2
Operating altitude	0 ... 2000 m / 0 ... 6562 ft
Mounting position	horizontal (standing/lying); vertical
Relative humidity (without condensation)	95 %
Vibration resistance	per IEC 60068-2-6
Shock resistance	15g per IEC 60068-2-27
EMC immunity to interference	per EN 61000-6-2
EMC emission of interference	per EN 61000-6-3

Subject to changes. Please also observe the further product documentation!

Exposure to pollutants	Per IEC 60068-2-42 and IEC 60068-2-43
Permissible H <sub>2</sub> S contaminant concentration at a relative humidity 75 %	10 ppm
Permissible SO <sub>2</sub> contaminant concentration at a relative humidity 75 %	25 ppm

### Commercial data

eCl@ss 10.0	27-24-26-05
eCl@ss 9.0	27-24-26-05
ETIM 8.0	EC001601
ETIM 7.0	EC001601
PU (SPU)	1 pcs
Packaging type	box
Country of origin	DE
GTIN	4055143374422
Customs tariff number	85389099990

### Environmental Product Compliance

CAS-No.	1314-23-4 1317-36-8 7439-92-1
REACH Candidate List Substance	Lead Lead monoxide Zirconium Oxide
RoHS Compliance Status	Compliant,With Exemption
RoHS Exemption	6(c) 7(a) 7(c)-I 7(c)-II
SCIP notification number (Bulgaria)	e3e85262-907a-4597-ae48-32a09b67dbb7
SCIP notification number (Czech Republic)	3571f887-aabc-4d71-87be-3c15cf0dd178

### Approvals / Certificates

#### General approvals

Logo	Approval	Additional Approval Text	Certificate name
	CCC CNEX	CNCA-C23-01	2020312310000213 (Ex ec IIC T4 Gc)



Subject to changes. Please also observe the further product documentation!



EAC  
Brjansker Zertifizierungsstelle

TP TC 020/2011





EAC RU C-DE.AM02.  
B.00087/19

	KC National Radio Research Agency	Article 58-2, Clause 3	MSIP-REM-W43- AIM750
	UL Underwriters Laboratories Inc. (ORDINARY LOCATIONS)	UL 508	E175199 Sec.1

#### Declarations of conformity and manufacturer's declarations

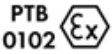
Logo	Approval	Additional Approval Text	Certificate name
	EU-Declaration of Conformity WAGO GmbH & Co. KG	-	-

#### Approvals for hazardous areas

Logo	Approval	Additional Approval Text	Certificate name
	ATEX TUEV Nord Cert GmbH	EN 60079-0	TUEV_14_ATEX_148929_X (II 3 G Ex ec IIC T4 Gc)
	CCC CNEX	CNCA-C23-01	2020312310000213 (Ex ec IIC T4 Gc)
	IECEX TUEV Nord Cert GmbH	IEC 60079-0	IECEX TUN 14.0035 X (Ex ec IIC T4 Gc)
	INMETRO TÜV Rheinland do Brasil Ltda.	IEC 60079-0	BR-Ex_TÜV 12.1297 X
	UKEx WAGO GmbH & Co. KG	EN 60079-0	UKCA_WAGO22UKEX003X_ec
	UL Underwriters Laboratories Inc. (HAZARDOUS LOCATIONS)	UL 121201	E198726 Sec.1

Subject to changes. Please also observe the further product documentation!

WAGO GmbH & Co. KG  
Hansastr. 27  
32423 Minden  
Phone: +49571 887-0 | Fax: +49571 887-169  
Email: [info.de@wago.com](mailto:info.de@wago.com) | Web: [www.wago.com](http://www.wago.com)







Do you have any questions about our products?  
We are always happy to take your call at +49 (571) 887-44222.



## Optional accessories





### Shield termination

#### Shield clamping saddles

	<b>Item no.: 790-116</b> Shield clamping saddle; 19 mm wide; diameter of compatible conductor; 7 ... 16 mm	<a href="http://www.wago.com/790-116">www.wago.com/790-116</a>
	<b>Item no.: 790-124</b> Shield clamping saddle; 27 mm wide; diameter of compatible conductor; 6 ... 24 mm	<a href="http://www.wago.com/790-124">www.wago.com/790-124</a>
	<b>Item no.: 790-108</b> Shield clamping saddle; 11 mm wide; diameter of compatible conductor; 3 ... 8 mm	<a href="http://www.wago.com/790-108">www.wago.com/790-108</a>
	<b>Item no.: 790-140</b> Shield clamping saddle; diameter of compatible conductor	<a href="http://www.wago.com/790-140">www.wago.com/790-140</a>
	<b>Item no.: 790-216</b> Shield clamping saddle; 21.8 mm wide; 6 ... 16 mm	<a href="http://www.wago.com/790-216">www.wago.com/790-216</a>
	<b>Item no.: 790-220</b> Shield clamping saddle; 30 mm wide; 6 ... 20 mm	<a href="http://www.wago.com/790-220">www.wago.com/790-220</a>
	<b>Item no.: 790-208</b> Shield clamping saddle; 12.4 mm wide; 3 ... 8 mm	<a href="http://www.wago.com/790-208">www.wago.com/790-208</a>

### Carrier rail

#### Mounting accessories

	<b>Item no.: 210-197</b> Steel carrier rail; 35 x 15 mm; 1.5 mm thick; 2 m long; slotted; similar to EN 60715; silver-colored	<a href="http://www.wago.com/210-197">www.wago.com/210-197</a>
	<b>Item no.: 210-198</b> Copper carrier rail; 35 x 15 mm; 2.3 mm thick; 2 m long; unslotted; according to EN 60715; copper-colored	<a href="http://www.wago.com/210-198">www.wago.com/210-198</a>
	<b>Item no.: 210-504</b> Steel carrier rail; 35 x 7.5 mm; 1 mm thick; 2 m long; slotted; galvanized; according to EN 60715; silver-colored	<a href="http://www.wago.com/210-504">www.wago.com/210-504</a>
	<b>Item no.: 210-505</b> Steel carrier rail; 35 x 7.5 mm; 1 mm thick; 2 m long; unslotted; galvanized; according to EN 60715; silver-colored	<a href="http://www.wago.com/210-505">www.wago.com/210-505</a>
	<b>Item no.: 210-506</b> Steel carrier rail; 35 x 15 mm; 1.5 mm thick; 2 m long; unslotted; galvanized; similar to EN 60715; silver-colored	<a href="http://www.wago.com/210-506">www.wago.com/210-506</a>
	<b>Item no.: 210-508</b>	

Subject to changes. Please also observe the further product documentation!



Steel carrier rail; 35 x 15 mm; 1.5 mm thick; 2 m long; slotted; galvanized; similar to EN 60715; silver-colored

[www.wago.com/210-508](http://www.wago.com/210-508)



**Item no.: 210-113**

Steel carrier rail; 35 x 7.5 mm; 1 mm thick; 2 m long; unslotted; according to EN 60715; silver-colored

[www.wago.com/210-113](http://www.wago.com/210-113)



**Item no.: 210-118**

Steel carrier rail; 35 x 15 mm; 2.3 mm thick; 2 m long; unslotted; according to EN 60715; silver-colored

[www.wago.com/210-118](http://www.wago.com/210-118)



**Item no.: 210-112**

Steel carrier rail; 35 x 7.5 mm; 1 mm thick; 2 m long; slotted; according to EN 60715; "Hole width 25 mm; silver-colored

[www.wago.com/210-112](http://www.wago.com/210-112)



**Item no.: 210-114**

Steel carrier rail; 35 x 15 mm; 1.5 mm thick; 2 m long; unslotted; similar to EN 60715; silver-colored

[www.wago.com/210-114](http://www.wago.com/210-114)



**Item no.: 210-115**

Steel carrier rail; 35 x 7.5 mm; 1 mm thick; 2 m long; slotted; according to EN 60715; "Hole width 18 mm; silver-colored

[www.wago.com/210-115](http://www.wago.com/210-115)



**Item no.: 210-196**

Aluminum carrier rail; 35 x 8.2 mm; 1.6 mm thick; 2 m long; unslotted; similar to EN 60715; silver-colored

[www.wago.com/210-196](http://www.wago.com/210-196)

## System housing

### System enclosure



**Item no.: 850-814/002-000**

IP65 enclosure; Sheet steel (RAL 7035); WxHxD (200x120x200 mm); without flange plate

[www.wago.com/850-814/002-000](http://www.wago.com/850-814/002-000)



**Item no.: 850-815/002-000**

IP65 enclosure; Sheet steel (RAL 7035); WxHxD (300x120x200 mm); without flange plate

[www.wago.com/850-815/002-000](http://www.wago.com/850-815/002-000)



**Item no.: 850-816/002-000**

IP65 enclosure; Sheet steel (RAL 7035); WxHxD (400x120x200 mm); without flange plate

[www.wago.com/850-816/002-000](http://www.wago.com/850-816/002-000)



**Item no.: 850-817/002-000**

IP65 enclosure; Sheet steel (RAL 7035); WxHxD (600x120x200 mm); without flange plate

[www.wago.com/850-817/002-000](http://www.wago.com/850-817/002-000)



**Item no.: 850-825**

IP65 enclosure; Aluminium (RAL 7032); WxHxD (160x100x160 mm); 9 x M12, 4 x M20

[www.wago.com/850-825](http://www.wago.com/850-825)



**Item no.: 850-826**

IP65 enclosure; Aluminium (RAL 7032); WxHxD (240x100x160 mm); 4 x M20, 4 x M16, 14 x M12 cable grip

[www.wago.com/850-826](http://www.wago.com/850-826)



**Item no.: 850-827**

IP65 enclosure; Aluminium (RAL 7032); WxHxD (320x100x160 mm); 4 x M20, 8 x M16, 17 x M12 cable grip

[www.wago.com/850-827](http://www.wago.com/850-827)

Subject to changes. Please also observe the further product documentation!

WAGO GmbH & Co. KG

Hansastr. 27

32423 Minden

Phone: +49571 887-0 | Fax: +49571 887-169

Email: [info.de@wago.com](mailto:info.de@wago.com) | Web: [www.wago.com](http://www.wago.com)

Do you have any questions about our products?

We are always happy to take your call at +49 (571) 887-44222.





**Item no.: 850-827/002-000**

IP65 enclosure; Aluminium (RAL 7035); WxHxD (320x100x160 mm); 4 x M20, 8 x M16, 17 x M12 cable grip

[www.wago.com/850-827/002-000](http://www.wago.com/850-827/002-000)



**Item no.: 850-826/002-000**

IP65 enclosure; Aluminium (RAL 7035); WxHxD (240x100x160 mm); 4 x M20, 4 x M16, 14 x M12 cable grip

[www.wago.com/850-826/002-000](http://www.wago.com/850-826/002-000)



**Item no.: 850-828/002-000**

IP65 enclosure; Aluminium (RAL 7035); WxHxD (480x100x160 mm); 4 x M20, 10 x M16, 35 x M12 cable grip

[www.wago.com/850-828/002-000](http://www.wago.com/850-828/002-000)



**Item no.: 850-828**

IP65 enclosure; Aluminium (RAL 7032); WxHxD (480x100x160 mm); 4 x M20, 10 x M16, 35 x M12 cable grip

[www.wago.com/850-828](http://www.wago.com/850-828)



**Item no.: 850-834**

IP65 enclosure; Polyester (RAL 7032); WxHxD (164x100x164 mm); 9 x M12, 4 x M20

[www.wago.com/850-834](http://www.wago.com/850-834)



**Item no.: 850-835**

IP65 enclosure; Polyester (RAL 7032); WxHxD (244x100x164 mm); 4 x M20, 4 x M16, 14 x M12 cable grip

[www.wago.com/850-835](http://www.wago.com/850-835)



**Item no.: 850-836**

IP65 enclosure; Polyester (RAL 7032); WxHxD (324x100x164 mm); 4 x M20, 8 x M16, 17 x M12 cable grip

[www.wago.com/850-836](http://www.wago.com/850-836)

**Voltage tap**

Power tap



**Item no.: 855-8001**

Power tap; with fuse; 2,5 mm<sup>2</sup> (12 AWG) - 6 mm<sup>2</sup> (10 AWG); Phase

[www.wago.com/855-8001](http://www.wago.com/855-8001)



**Item no.: 855-8002**

Power tap; without fuse; 2,5 mm<sup>2</sup> (12 AWG) - 6 mm<sup>2</sup> (10 AWG); N-conductor

[www.wago.com/855-8002](http://www.wago.com/855-8002)



**Item no.: 855-8004**

Power tap; without fuse; 10 mm<sup>2</sup> (8 AWG) - 16 mm<sup>2</sup> (6 AWG); N-conductor

[www.wago.com/855-8004](http://www.wago.com/855-8004)



**Item no.: 855-8003**

Power tap; with fuse; 10 mm<sup>2</sup> (8 AWG) - 16 mm<sup>2</sup> (6 AWG); Phase

[www.wago.com/855-8003](http://www.wago.com/855-8003)

**Current transformers**

Split-core current transformer



**Item no.: 855-4105/250-101**

Split-core current transformer; Primary rated current: 250 A; Secondary rated current: 5 A; Rated power: 1 VA; Accuracy class: 1; Cable length: 0.5 m

[www.wago.com/855-4105/250-101](http://www.wago.com/855-4105/250-101)



**Item no.: 855-4105/400-101**

Split-core current transformer; Primary rated current: 400 A; Secondary rated current: 5 A; Rated power: 1 VA; Accuracy class: 1; Cable length: 0.5 m

[www.wago.com/855-4105/400-101](http://www.wago.com/855-4105/400-101)

**Item no.: 855-5005/1000-000**

Subject to changes. Please also observe the further product documentation!

WAGO GmbH & Co. KG

Hansastr. 27

32423 Minden

Phone: +49571 887-0 | Fax: +49571 887-169

Email: [info.de@wago.com](mailto:info.de@wago.com) | Web: [www.wago.com](http://www.wago.com)

Do you have any questions about our products?

We are always happy to take your call at +49 (571) 887-44222.



Split-core current transformer; Primary rated current: 1000 A; Secondary rated current: 5 A; Rated power: 0.5 VA; Accuracy class: 0.5; Cable length: 3 m

[www.wago.com/855-5005/1000-000](http://www.wago.com/855-5005/1000-000)



**Item no.: 855-5005/400-001**

Split-core current transformer; Primary rated current: 400 A; Secondary rated current: 5 A; Rated power: 0.5 VA; Accuracy class: 1; Cable length: 3 m

[www.wago.com/855-5005/400-001](http://www.wago.com/855-5005/400-001)



**Item no.: 855-5005/600-000**

Split-core current transformer; Primary rated current: 600 A; Secondary rated current: 5 A; Rated power: 0.5 VA; Accuracy class: 0.5; Cable length: 3 m

[www.wago.com/855-5005/600-000](http://www.wago.com/855-5005/600-000)



**Item no.: 855-5105/1000-000**

Split-core current transformer; Primary rated current: 1000 A; Secondary rated current: 5 A; Rated power: 0.5 VA; Accuracy class: 0.5; Cable length: 3 m

[www.wago.com/855-5105/1000-000](http://www.wago.com/855-5105/1000-000)



**Item no.: 855-4005/150-101**

Split-core current transformer; Primary rated current: 150 A; Secondary rated current: 5 A; Rated power: 1 VA; Accuracy class: 1; Cable length: 0.5 m

[www.wago.com/855-4005/150-101](http://www.wago.com/855-4005/150-101)

#### Current transformer terminal block



**Item no.: 2007-8875**

Compact terminal block; for current transformer circuit; 6,00 mm<sup>2</sup>; multicoloured

[www.wago.com/2007-8875](http://www.wago.com/2007-8875)



**Item no.: 2007-8873**

Compact terminal block; for current and voltage transformers; 6,00 mm<sup>2</sup>; multicoloured

[www.wago.com/2007-8873](http://www.wago.com/2007-8873)

#### Plug-in current transformer



**Item no.: 855-305/050-103**

Plug-in current transformer; Primary rated current: 50 A; Secondary rated current: 5 A; Rated power: 1.25 VA; Accuracy class: 3

[www.wago.com/855-305/050-103](http://www.wago.com/855-305/050-103)



**Item no.: 855-305/060-101**

Plug-in current transformer; Primary rated current: 60 A; Secondary rated current: 5 A; Rated power: 1.25 VA; Accuracy class: 1

[www.wago.com/855-305/060-101](http://www.wago.com/855-305/060-101)



**Item no.: 855-305/075-201**

Plug-in current transformer; Primary rated current: 75 A; Secondary rated current: 5 A; Rated power: 2.5 VA; Accuracy class: 1

[www.wago.com/855-305/075-201](http://www.wago.com/855-305/075-201)

**Item no.: 855-305/100-201**

Subject to changes. Please also observe the further product documentation!

WAGO GmbH & Co. KG

Hansastr. 27

32423 Minden

Phone: +49571 887-0 | Fax: +49571 887-169

Email: [info.de@wago.com](mailto:info.de@wago.com) | Web: [www.wago.com](http://www.wago.com)

Do you have any questions about our products?

We are always happy to take your call at +49 (571) 887-44222.



Plug-in current transformer; Primary rated current: 100 A; Secondary rated current: 5 A; Rated power: 2.5 VA; Accuracy class: 1 [www.wago.com/855-305/100-201](http://www.wago.com/855-305/100-201)



**Item no.: 855-305/150-501**  
Plug-in current transformer; Primary rated current: 150 A; Secondary rated current: 5 A; Rated power: 5 VA; Accuracy class: 1 [www.wago.com/855-305/150-501](http://www.wago.com/855-305/150-501)



**Item no.: 855-605/1500-501**  
Plug-in current transformer; Primary rated current: 1500 A; Secondary rated current: 5 A; Rated power: 5 VA; Accuracy class: 1 [www.wago.com/855-605/1500-501](http://www.wago.com/855-605/1500-501)



**Item no.: 855-805/2000-1001**  
Plug-in current transformer; Primary rated current: 2000 A; Secondary rated current: 5 A; Rated power: 10 VA; Accuracy class: 1 [www.wago.com/855-805/2000-1001](http://www.wago.com/855-805/2000-1001)



**Item no.: 855-1005/2500-1001**  
Plug-in current transformer; Primary rated current: 2500 A; Secondary rated current: 5 A; Rated power: 10 VA; Accuracy class: 1 [www.wago.com/855-1005/2500-1001](http://www.wago.com/855-1005/2500-1001)



**Item no.: 855-505/1000-1001**  
Plug-in current transformer; Primary rated current: 1000 A; Secondary rated current: 5 A; Rated power: 10 VA; Accuracy class: 1 [www.wago.com/855-505/1000-1001](http://www.wago.com/855-505/1000-1001)



**Item no.: 855-505/600-1001**  
Plug-in current transformer; Primary rated current: 600 A; Secondary rated current: 5 A; Rated power: 10 VA; Accuracy class: 1 [www.wago.com/855-505/600-1001](http://www.wago.com/855-505/600-1001)



**Item no.: 855-505/400-1001**  
Plug-in current transformer; Primary rated current: 400 A; Secondary rated current: 5 A; Rated power: 10 VA; Accuracy class: 1 [www.wago.com/855-505/400-1001](http://www.wago.com/855-505/400-1001)



**Item no.: 855-505/800-1001**  
Plug-in current transformer; Primary rated current: 800 A; Secondary rated current: 5 A; Rated power: 10 VA; Accuracy class: 1 [www.wago.com/855-505/800-1001](http://www.wago.com/855-505/800-1001)



**Item no.: 855-305/200-501**  
Plug-in current transformer; Primary rated current: 200 A; Secondary rated current: 5 A; Rated power: 5 VA; Accuracy class: 1 [www.wago.com/855-305/200-501](http://www.wago.com/855-305/200-501)



**Item no.: 855-305/250-501**  
Plug-in current transformer; Primary rated current: 250 A; Secondary rated current: 5 A; Rated power: 5 VA; Accuracy class: 1 [www.wago.com/855-305/250-501](http://www.wago.com/855-305/250-501)

**Item no.: 855-305/300-501**

Subject to changes. Please also observe the further product documentation!



Plug-in current transformer; Primary rated current 300 A; Secondary rated current: 5 A; Rated power: 5 VA; Accuracy class: 1 [www.wago.com/855-305/300-501](http://www.wago.com/855-305/300-501)



**Item no.: 855-305/400-1001**  
Plug-in current transformer; Primary rated current: 400 A; Secondary rated current: 5 A; Rated power: 10 VA; Accuracy class: 1 [www.wago.com/855-305/400-1001](http://www.wago.com/855-305/400-1001)



**Item no.: 855-305/600-1001**  
Plug-in current transformer; Primary rated current: 600 A; Secondary rated current: 5 A; Rated power: 10 VA; Accuracy class: 1 [www.wago.com/855-305/600-1001](http://www.wago.com/855-305/600-1001)



**Item no.: 855-405/250-501**  
Plug-in current transformer; Primary rated current: 250 A; Secondary rated current: 5 A; Rated power: 5 VA; Accuracy class: 1 [www.wago.com/855-405/250-501](http://www.wago.com/855-405/250-501)



**Item no.: 855-405/400-501**  
Plug-in current transformer; Primary rated current: 400 A; Secondary rated current: 5 A; Rated power: 5 VA; Accuracy class: 1 [www.wago.com/855-405/400-501](http://www.wago.com/855-405/400-501)



**Item no.: 855-405/750-501**  
Plug-in current transformer; Primary rated current 750 A; Secondary rated current: 5 A; Rated power: 5 VA; Accuracy class: 1 [www.wago.com/855-405/750-501](http://www.wago.com/855-405/750-501)

#### Marking accessories

##### Marker carrier



**Item no.: 750-103**  
Group marker carrier [www.wago.com/750-103](http://www.wago.com/750-103)

##### Marker



**Item no.: 2009-145/000-006**  
Mini-WSB Inline; for Smart Printer; 1700 pieces on roll; stretchable 5 - 5.2 mm; plain; snap-on type; blue [www.wago.com/2009-145/000-006](http://www.wago.com/2009-145/000-006)



**Item no.: 2009-145**  
Mini-WSB Inline; for Smart Printer; 1700 pieces on roll; stretchable 5 - 5.2 mm; plain; snap-on type; white [www.wago.com/2009-145](http://www.wago.com/2009-145)















**Item no.: 2009-145/000-002**  
Mini-WSB Inline; for Smart Printer; 1700 pieces on roll; stretchable 5 - 5.2 mm; plain; snap-on type; yellow [www.wago.com/2009-145/000-002](http://www.wago.com/2009-145/000-002)



**Item no.: 2009-145/000-007**  
Mini-WSB Inline; for Smart Printer; 1700 pieces on roll; stretchable 5 - 5.2 mm; plain; snap-on type; gray [www.wago.com/2009-145/000-007](http://www.wago.com/2009-145/000-007)

Subject to changes. Please also observe the further product documentation!

	<p><b>Item no.: 2009-145/000-005</b> Mini-WSB Inline; for Smart Printer; 1700 pieces on roll; stretchable 5 - 5.2 mm; plain; snap-on type; red</p>	<p><a href="http://www.wago.com/2009-145/000-005">www.wago.com/2009-145/000-005</a></p>
	<p><b>Item no.: 2009-145/000-012</b> Mini-WSB Inline; for Smart Printer; 1700 pieces on roll; stretchable 5 - 5.2 mm; plain; snap-on type; orange</p>	<p><a href="http://www.wago.com/2009-145/000-012">www.wago.com/2009-145/000-012</a></p>
	<p><b>Item no.: 2009-145/000-023</b> Mini-WSB Inline; for Smart Printer; 1700 pieces on roll; stretchable 5 - 5.2 mm; plain; snap-on type; green</p>	<p><a href="http://www.wago.com/2009-145/000-023">www.wago.com/2009-145/000-023</a></p>
	<p><b>Item no.: 2009-145/000-024</b> Mini-WSB Inline; for Smart Printer; 1700 pieces on roll; stretchable 5 - 5.2 mm; plain; snap-on type; violet</p>	<p><a href="http://www.wago.com/2009-145/000-024">www.wago.com/2009-145/000-024</a></p>
	<p><b>Item no.: 248-501/000-006</b> Mini-WSB marking card; as card; not stretchable; plain; snap-on type; blue</p>	<p><a href="http://www.wago.com/248-501/000-006">www.wago.com/248-501/000-006</a></p>
	<p><b>Item no.: 248-501/000-007</b> Mini-WSB marking card; as card; not stretchable; plain; snap-on type; gray</p>	<p><a href="http://www.wago.com/248-501/000-007">www.wago.com/248-501/000-007</a></p>
	<p><b>Item no.: 248-501/000-002</b> Mini-WSB marking card; as card; not stretchable; plain; snap-on type; yellow</p>	<p><a href="http://www.wago.com/248-501/000-002">www.wago.com/248-501/000-002</a></p>
	<p><b>Item no.: 248-501/000-012</b> Mini-WSB marking card; as card; not stretchable; plain; snap-on type; orange</p>	<p><a href="http://www.wago.com/248-501/000-012">www.wago.com/248-501/000-012</a></p>
	<p><b>Item no.: 248-501</b> Mini-WSB marking card; as card; not stretchable; plain; snap-on type; white</p>	<p><a href="http://www.wago.com/248-501">www.wago.com/248-501</a></p>
	<p><b>Item no.: 248-501/000-017</b> Mini-WSB marking card; as card; not stretchable; plain; snap-on type; light green</p>	<p><a href="http://www.wago.com/248-501/000-017">www.wago.com/248-501/000-017</a></p>
	<p><b>Item no.: 248-501/000-005</b> Mini-WSB marking card; as card; not stretchable; plain; snap-on type; red</p>	<p><a href="http://www.wago.com/248-501/000-005">www.wago.com/248-501/000-005</a></p>
	<p><b>Item no.: 248-501/000-024</b> Mini-WSB marking card; as card; not stretchable; plain; snap-on type; violet</p>	<p><a href="http://www.wago.com/248-501/000-024">www.wago.com/248-501/000-024</a></p>

Subject to changes. Please also observe the further product documentation!



Item no.: 248-501/000-023

Mini-WSB marking card; as card; not stretchable; plain; snap-on type; green

[www.wago.com/248-501/000-023](http://www.wago.com/248-501/000-023)

Group marker carrier



Item no.: 750-107

Group marker carrier

[www.wago.com/750-107](http://www.wago.com/750-107)

## Downloads

### Documentation

#### Manual

System Manual WAGO I/O System 750/753 Decentralized Automation Technology	V 3.3.0 2023 May 4	pdf 8.8 MB	Download
Product Manual 3-Phase Power Measurement Module	V 1.2.0	pdf 3.4 MB	Download
System Manual Series 750/753 Online HTML		URL	Download

#### Bid Text

750-493/000-001 docx - Datei	2019 Jun 26	docx 18.5 kB	Download
750-493/000-001 X81 - Datei	2019 Feb 19	xml 6.0 kB	Download

#### Instruction Leaflet

CCC Ex (Additional information) WAGO-I/O-SYSTEM *750-****/*	2023 Apr 26	pdf 163.6 kB	Download
--	-------------	-----------------	----------

#### System Description

Overview on WAGO-I/O-SYSTEM 750 approvals		pdf 789.0 kB	Download
750/753 Series I/O-System – General Product Information		pdf 1.7 MB	Download

#### Additional Information

Subject to changes. Please also observe the further product documentation!

WAGO GmbH & Co. KG  
Hansastr. 27  
32423 Minden  
Phone: +49571 887-0 | Fax: +49571 887-169  
Email: [info.de@wago.com](mailto:info.de@wago.com) | Web: [www.wago.com](http://www.wago.com)

Do you have any questions about our products?  
We are always happy to take your call at +49 (571) 887-44222.



Disposal and Recycling  
Electrical and electronic equipment, Batteries, Packaging

V 1.1.0  
2022 Aug 18

pdf  
2.2 MB

[Download](#)

## CAD/CAE-Data

### CAE data

EPLAN Data Portal 750-493/000-001 [URL](#) [Download](#)

WSCAD Universe 750-493/000-001 [URL](#) [Download](#)

ZUKEN Portal 750-493/000-001 [URL](#) [Download](#)

WSCAD Universe 750-493/000-001 [URL](#) [Download](#)

EPLAN Data Portal 750-493/000-001 [URL](#) [Download](#)

### CAD data

2D/3D Models 750-493/000-001 [URL](#) [Download](#)

## Device Files

### Device Driver

WAGO USB Service Kabel Treiber / Serie 750 und 857 [6.5.3.0](#) [zip](#) [Download](#)  
2014 Sep 10 4.8 MB

## Environmental Product Compliance

### Compliance Search

Environmental Product Compliance 750-493/000-001 [URL](#) [Download](#)  
3-Phase Power Measurement; 480 VAC, 5 A

## Installation Notes

Subject to changes. Please also observe the further product documentation!



## Product family

WAGO I/O System 750/753

[Show all products from the family](#)

Subject to changes. Please also observe the further product documentation!

---

WAGO GmbH & Co. KG

Hansastr. 27

32423 Minden

Phone: +49571 887-0 | Fax: +49571 887-169

Email: [info.de@wago.com](mailto:info.de@wago.com) | Web: [www.wago.com](http://www.wago.com)

Do you have any questions about our products?

We are always happy to take your call at +49 (571) 887-44222.