

Mechanical Dimensions (mm)

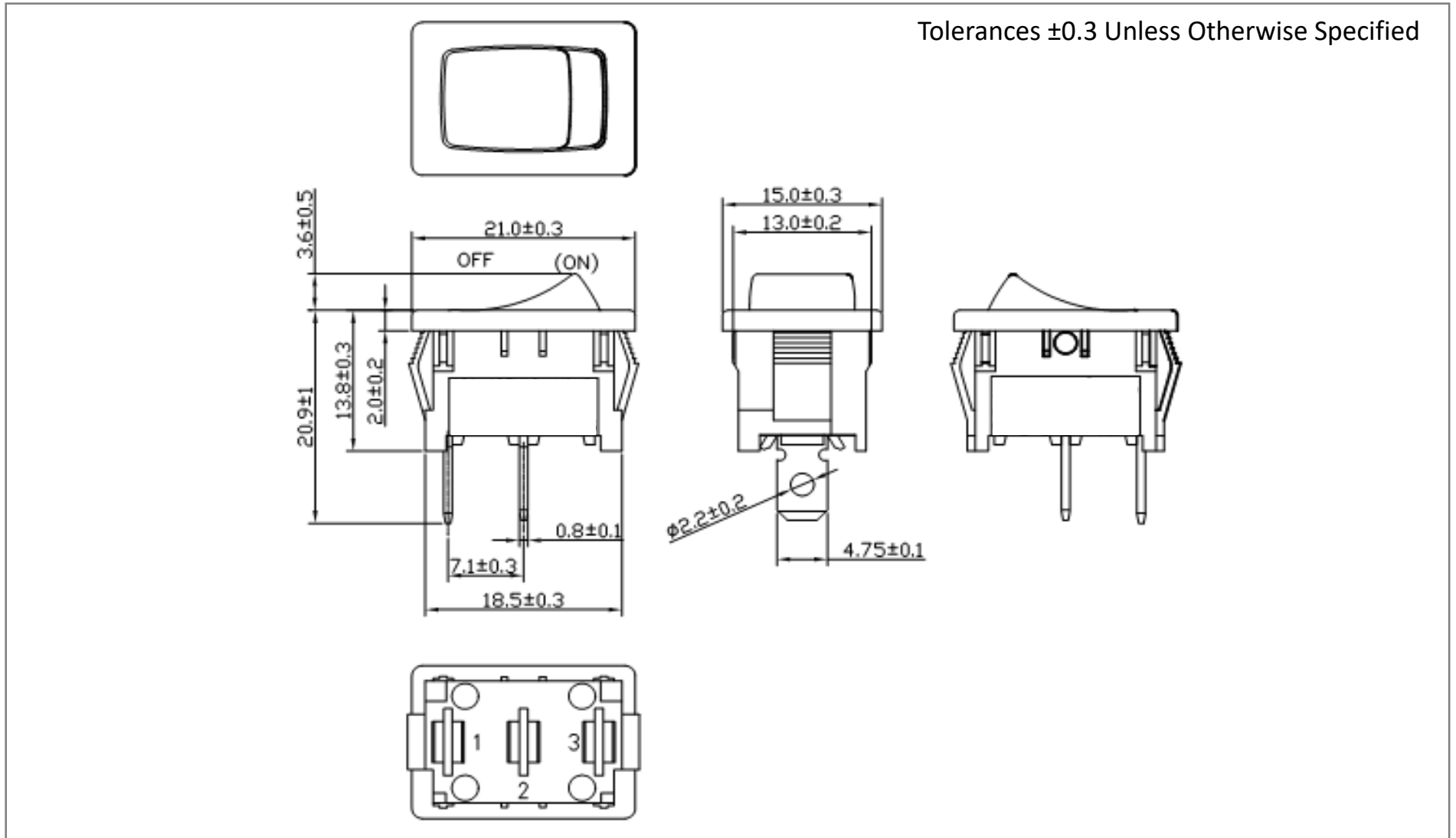

Mounting Hole

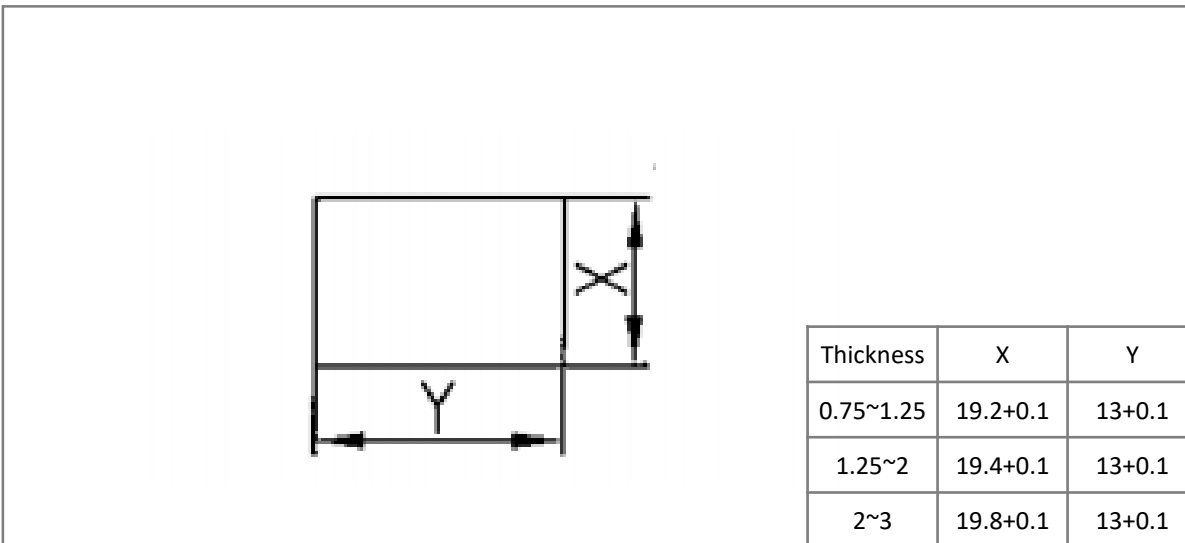

Circuit Diagram

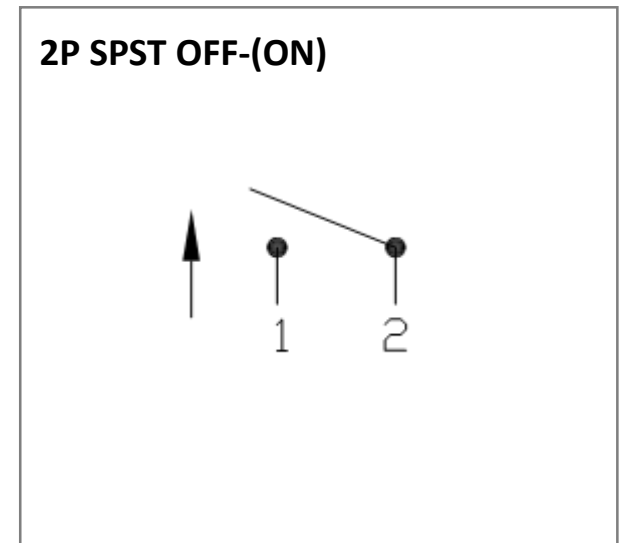

Electrical Specifications

Rating	20A 12V DC 10A 24V DC	
Contact Resistance	50m ohm Max.	
Insulation Resistance	DC 500V 100M ohm Min.	
Dielectric Strength	AC 1500V 1 minute	
Operation Temperature	-20°C~85°C	

Material Specifications

Frame	Black, Nylon 66
Actuator	Black, Nylon 66