

# LUXEON 3535 HV

High voltage package that reduces system BOM while achieving high efficacy



## Introduction

The LUXEON 3535 HV mid power product is a SMD solution that comes in both 24V and 48V configurations. This 3535 high-voltage architecture allows for freedom of design when a LED project requires less bulky, more efficient drivers and an ultimate cost down on the LED system. LUXEON 3535 HV is consistent with our LUXEON 3535L dimensions of 3.5mm x 3.5mm x 0.8mm for ease of installation.

### Features

- Multi-junction die
- High voltage
- Excellent current spreading
- High light output per package

### Benefits

- Enables a cost down on driver
- Lower current, more efficient driver
- Leads to better extraction of light
- Allows reduction in LED count

### Key Applications

- Down lights
- Indoor Area Lighting
- Bulbs
- Wall Sconce
- Wall Pack

## General Information

### Product Nomenclature

LUXEON 3535HV is tested and binned at  $T_j = 25^\circ\text{C}$  with a drive current of 15 mA DC.

The part number designation is explained as follow:

L135 - AABB CDHV00001

Where:

A — designates CCT (2700K = 27)

B — designates CRI (70, 80 and 90)

C — designates color (W for White)

D — designates voltage (A=12V, B=24V, C=48V)

For example, a white LUXEON 3535HV 4000K/80CRI 24V emitter has the following part number:

L135 – 4080WBHV00001

## Average Lumen Maintenance Characteristics

Lumen maintenance for solid-state lighting devices (LEDs) is typically defined in terms of the percentage of initial light output remaining after a specified period of time. Philips Lumileds projects that LUXEON 3535 HV products will deliver, on average, 70% lumen maintenance (L70) at >30,000 hours of operation at a forward current of up to 15 mA at  $T_j = 25^\circ\text{C}$ . This projection and detailed operating condition will be further validated and disclosed respectively at the time of product launch. Observation of design limits included in this data sheet is required in order to achieve this projected lumen maintenance.

## Environmental Compliance

Philips Lumileds is committed to providing environmentally friendly products to the solid-state lighting market.

LUXEON 3535 HV is compliant to the European Union directives on the restriction of hazardous substances in electronic equipment, namely the RoHS and REACH directives. Philips Lumileds will not intentionally add the following restricted material to the LUXEON 3535 HV L135-XX800XHV00001: lead, mercury, cadmium, hexavalent chromium, polybrominated biphenyls (PBB) or polybrominated diphenyl ethers (PBDE).

## Product Selection

### Product Selection Guide for LUXEON 3535 HV Mid-Power LEDs Junction Temperature = $25^\circ\text{C}$

Table 1.

Voltage	Nominal CCT	Part Number	Luminous Flux (lm) <sup>1</sup> @ 15mA		Luminous Flux (lm) <sup>1</sup> @ 20mA	CRI <sup>1</sup>	Rth ( $^\circ\text{C}/\text{W}$ )
			Min.	Typ.	Typ.	Min.	Typ.
24	2700K	L135-27800BHV00001	37	41	53	80	25

Voltage	Nominal CCT	Part Number	Luminous Flux (lm) <sup>1</sup> @ 15mA		Luminous Flux (lm) <sup>1</sup> @ 20mA	CRI <sup>1</sup>	R <sub>th</sub> (°C/W)
			Min.	Typ.	Typ.	Min.	Typ.
24	3000K	LI35-30800BHV0000I	39	43	55	80	25
24	4000K	LI35-40800BHV0000I	42	48	60	80	25
24	5000K	LI35-50800BHV0000I	42	48	60	80	25
48	2700K	LI35-27800CHV0000I	71	80	102	80	18
48	3000K	LI35-30800CHV0000I	75	84	107	80	18
48	4000K	LI35-40800CHV0000I	83	93	120	80	18
48	5000K	LI35-50800CHV0000I	83	93	120	80	18

Notes for Table 1:

1. Philips Lumileds maintains a tolerance of  $\pm 7.5\%$  on luminous flux,  $\pm 2$  on CRI
2. Forward voltage test tolerance :  $\pm 0.1$  volts

## Electrical Characteristics

Junction Temperature = 25°C, Test Current @ 15mA

Table 2.

Part Numbers	Forward Voltage V <sub>f</sub> (V)			Temperature Coefficient of Forward Voltage between 25°C-85°C (dV <sub>f</sub> /dT <sub>j</sub> )
	Minimum	Typical	Maximum	
LI35-2780-0BHV-0000I				
LI35-3080-0BHV-0000I				
LI35-4080-0BHV-0000I	22	24	26	-2.0-4.0
LI35-5080-0BHV-0000I				
LI35-2780-0CHV-0000I				
LI35-3080-0CHV-0000I				
LI35-4080-0CHV-0000I	44	48	52	-2.0-4.0
LI35-5080-0CHV-0000I				

## Absolute Maximum Ratings

Table 3.

Parameter	Maximum Performance
DC Forward Current	30 mA <sup>[1]</sup>
Peak Pulsed Forward Current	35 mA <sup>[2]</sup>

Parameter	Maximum Performance
ESD Sensitivity	< 2000V Human Body Model (HBM) Class 2A JESD22-A114-E < 400V Machine Model (MM) Class C JESD22-A115-B
Operating Case Temperature @ 15mA	-40°C - 105°C
Soldering temperature	JEDEC 020D 260 °C
Storage Temperature	-40°C - 100°C
LED Junction Temperature <sup>[1]</sup>	125°C
Allowable Reflow Cycles	3
Reverse Voltage	n/a

Notes for Table 3:

1. Ripple current with a frequency of 50-150 Hz is allowed as long as the average of the current waveform is below 30mA and the maximum of the current waveform is lower than 40mA
2. At 10% duty cycle and pulse width 10ms
3. LUXEON 3535 HV LEDs are not designed to be driven in reverse bias.
4. At a maximum reverse current of 10  $\mu$ A

## JEDEC Moisture Sensitivity

Table 4.

Level	Floor Life		Soak Requirements	
			Standard	
	Time	Conditions	Time	Conditions
2	1 year	$\leq 30^{\circ}\text{C} / 60\% \text{ RH}$	168 Hrs. +/- 5/0 Hrs.	$\leq 85^{\circ}\text{C} / 60\% \text{ RH}$

# Reflow Soldering Characteristics

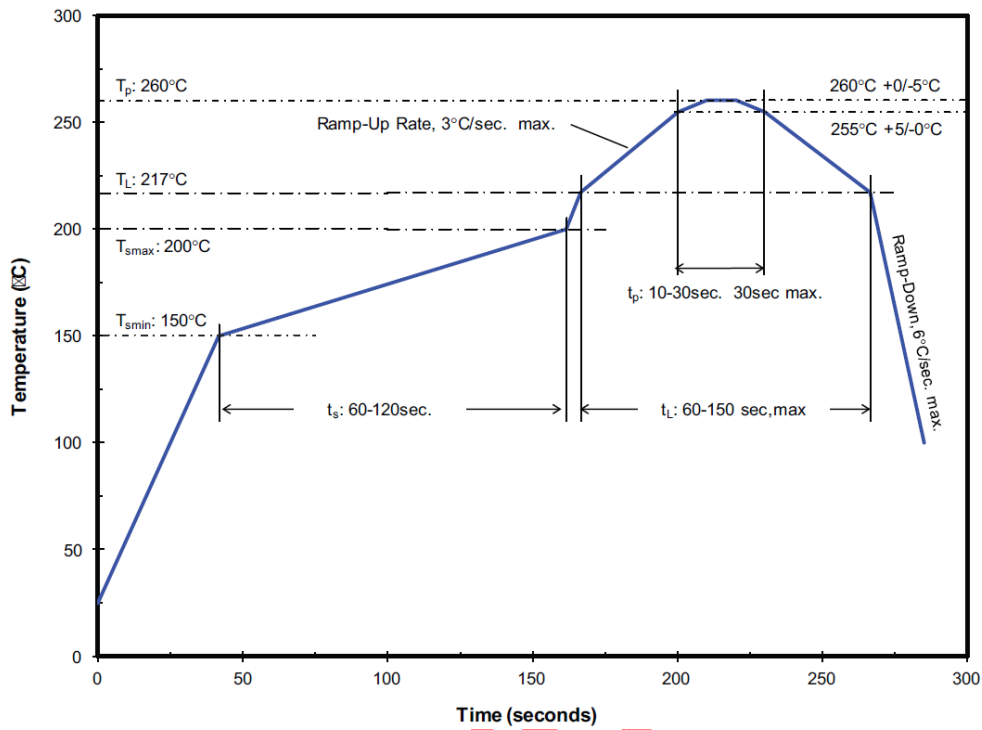

Figure 1. Temperature profile for Table 5

Table 5. Reflow Profile in Accordance with J-Std-020D

Profile Feature	Lead Free Assembly
Preheat/Soak:	
Temperature Min ( $T_{smin}$ )	150 °C
Temperature Max ( $T_{smax}$ )	200 °C
Maximum Time ( $t_s$ ) from $T_{smin}$ to $T_{smax}$	120 seconds
Ramp-up Rate ( $T_L$ to $T_p$ )	3 °C / second
Liquidous Temperature ( $T_L$ )	217 °C
Maximum Time ( $t_L$ ) Maintained $T_L$	150 seconds
Maximum Peak Package Body Temperature ( $T_p$ )	260 °C
Time ( $t_p$ ) within 5 °C of the specified temperature ( $T_c$ )	10-30 seconds
Maximum Ramp-Down Rate ( $T_p$ to $T_L$ )	6 °C/second
Maximum Time 25 °C to Peak Temperature	8 minutes

Notes for Table 5:

- I. All temperatures refer to the application Printed Circuit Board (PCB), measured on the surface adjacent to the package body.

# Mechanical Dimensions and Package Information

## Mechanical Dimensions

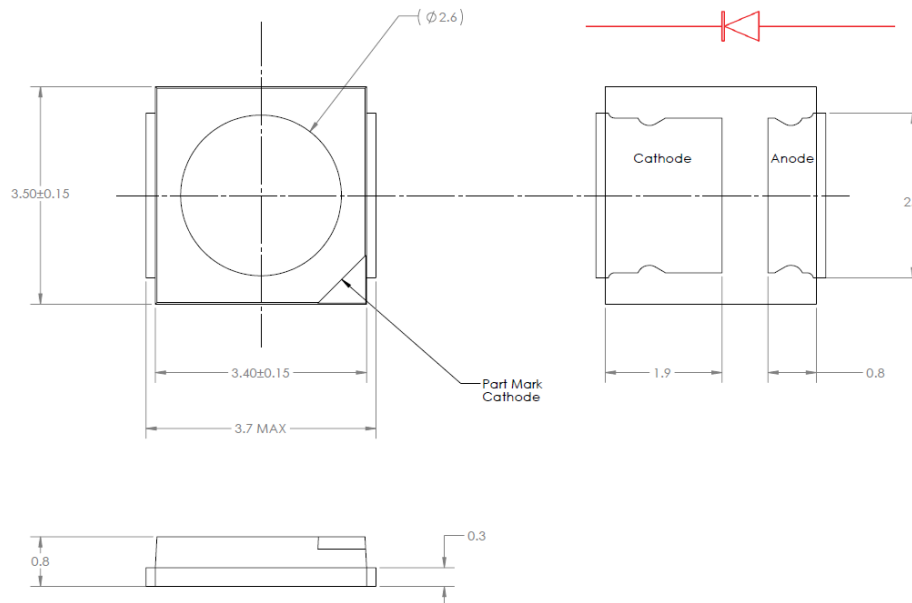
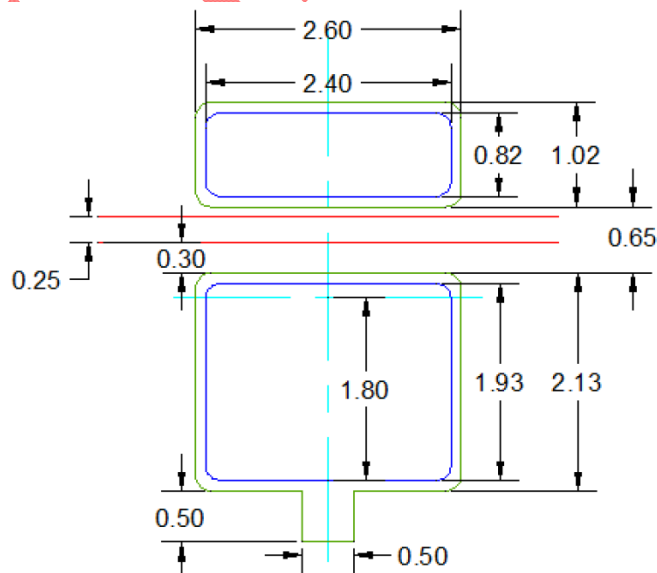

Figure 2.

Notes for Figure 2:

1. All dimensions are in millimeters.
2. Tolerance  $\pm 0.10$  mm.

## Solder Pad Design



Notes for Figure 3:

1. The drawing above shows the recommend solder pad layout on the Printed Circuit Board (PCB)
2. All dimensions are in mm
3. Application Brief AB203 provides details for this layout. In addition, the .drawing files are available at [www.philipsumileds.com](http://www.philipsumileds.com) and [www.philipsumileds.cn.com](http://www.philipsumileds.cn.com)

## Package Information

Table 6. Package Information for L135-xx80-0xHV-00001

Material/Component	Specification
Lead Frame Base	Copper Alloy
Package Body	High Temperature Thermal Plastic
Encapsulate	Silicone Resin. with Phosphor
Weight	0.08gram

PRELIMINARY



# Characteristic Curves

Relative Spectral Distribution vs. Wavelength  
Junction Temperature = 25°C; Test Current = 15 mA

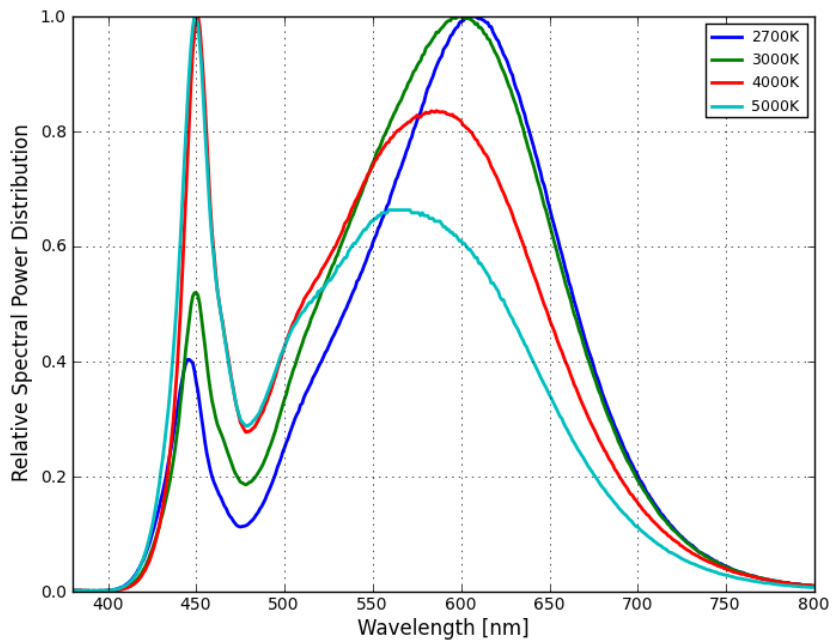

Figure 4. Color spectrum, L135-xx80-0xHV-00001

Relative Light Output Characteristics over Junction Temperature  
Test Current = 15 mA

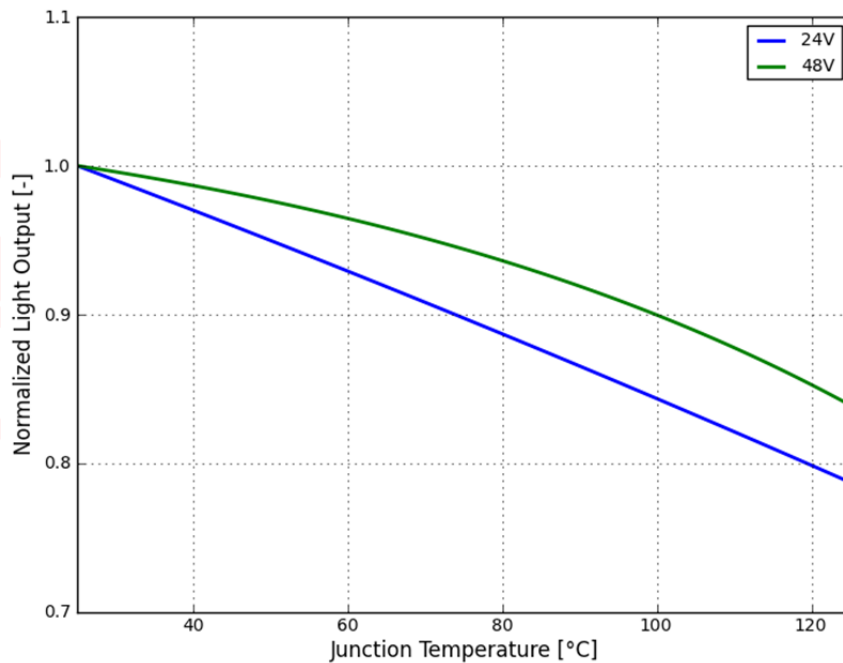

Figure 5. Relative light output vs. junction temperature, L135-xx80-0xHV-00001

# Typical Forward Current Characteristics

Forward Current vs. Forward Voltage for L135-xx80-0BHV-00001  
Junction Temperature = 25°C

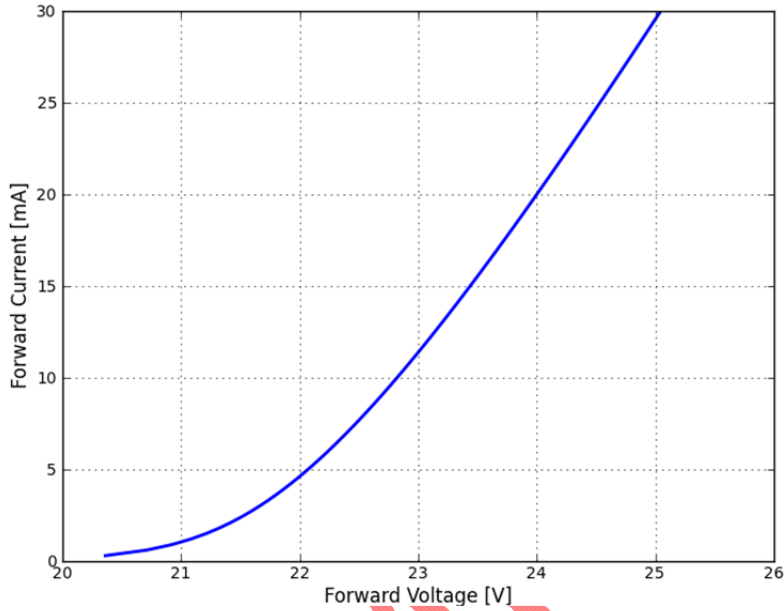

Figure 6. Typical forward current vs. forward voltage, L135-xx80-0BHV-00001

Forward Current vs. Forward Voltage for L135-xx80-0CHV-00001  
Junction Temperature = 25°C

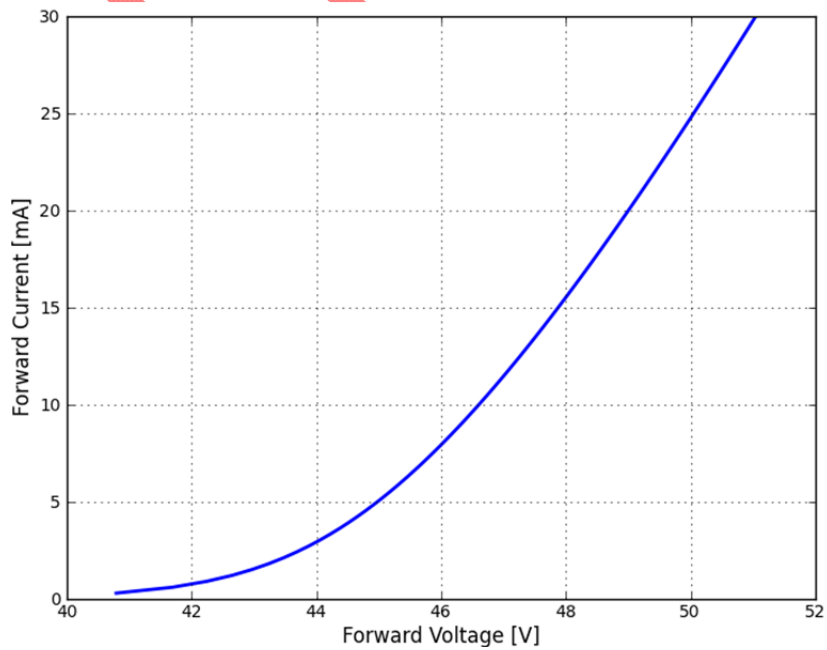

Figure 7 Typical forward current vs. forward voltage, L135-xx80-0CHV-00001

# Typical Light Output Characteristics

Relative Light Output vs. Forward Current  
Junction Temperature = 25°C

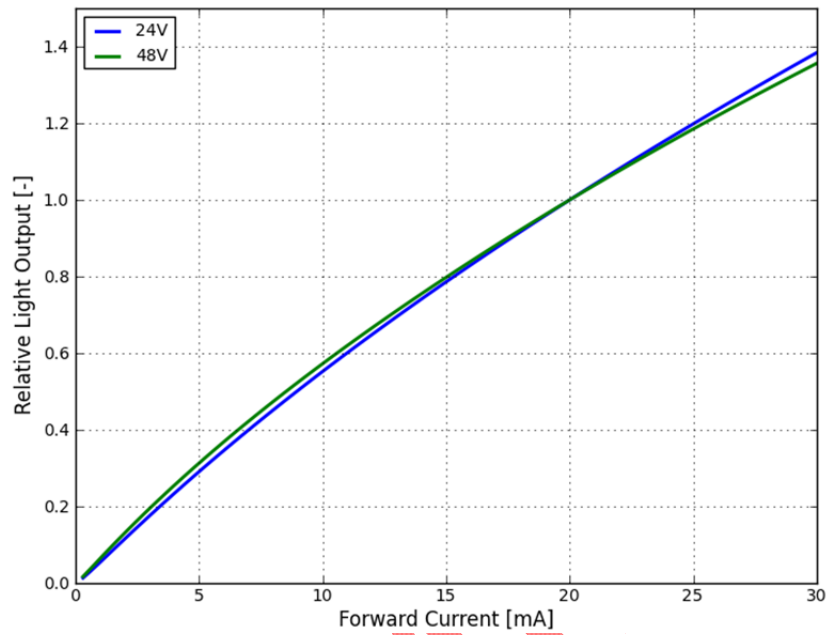

Figure 8. Relative light output vs. forward current, L135-xx80-0xHV-00001

PRELIMINARY



# Typical Radiation Patterns

Radiation Pattern in Cartesian Coordinate System  
Junction Temperature = 25°C

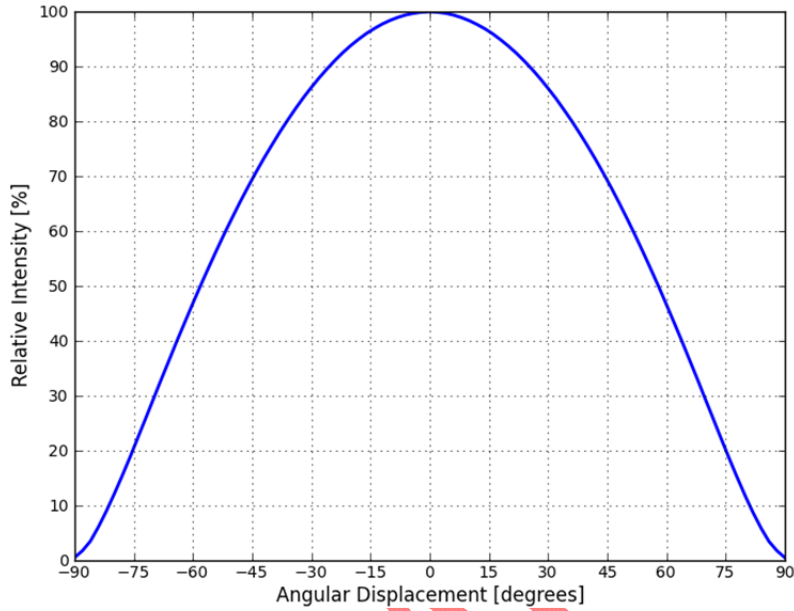

Figure 9. Typical spatial radiation pattern, L135-xx80-0xHV-00001

Radiation Pattern in Polar Coordinate System  
Junction Temperature = 25°C

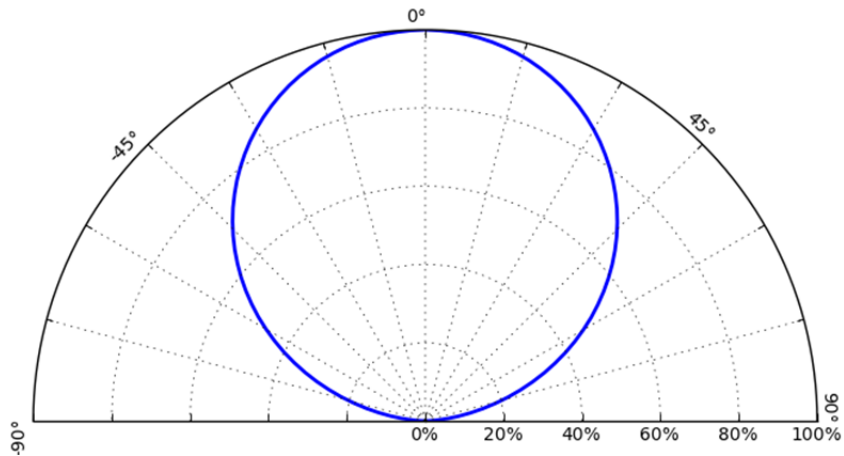

Figure 10. Typical polar radiation pattern, L135-xx80-0xHV-00001

# Emitter Packaging

## Emitter Pocket Tape Packaging

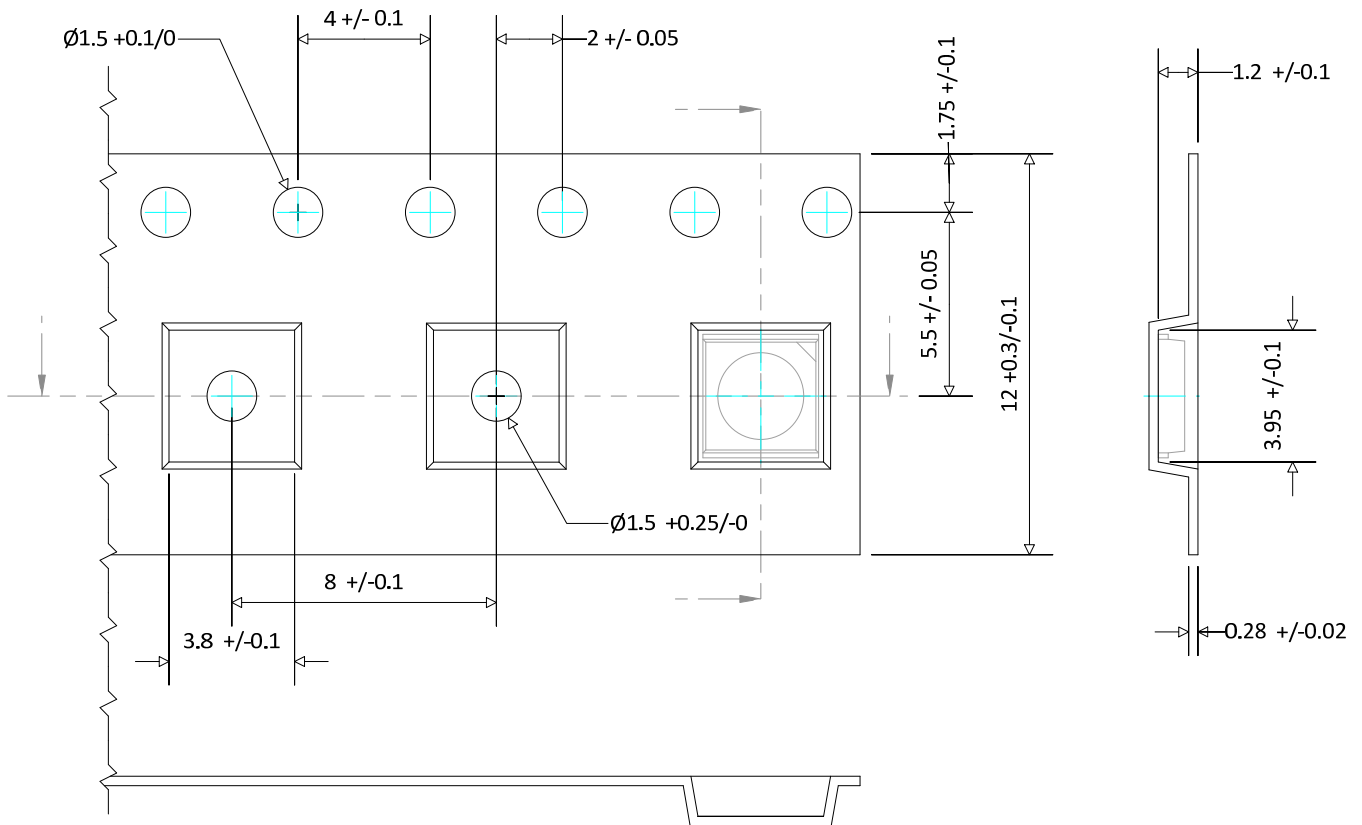

Figure 11.

Notes for Figure 11:

1. All dimensions are in millimeters
2. Empty component pockets sealed with top cover tape
3. The maximum number of consecutive missing LEDs is two

PRELIMINARY

## Emitter Reel Packaging

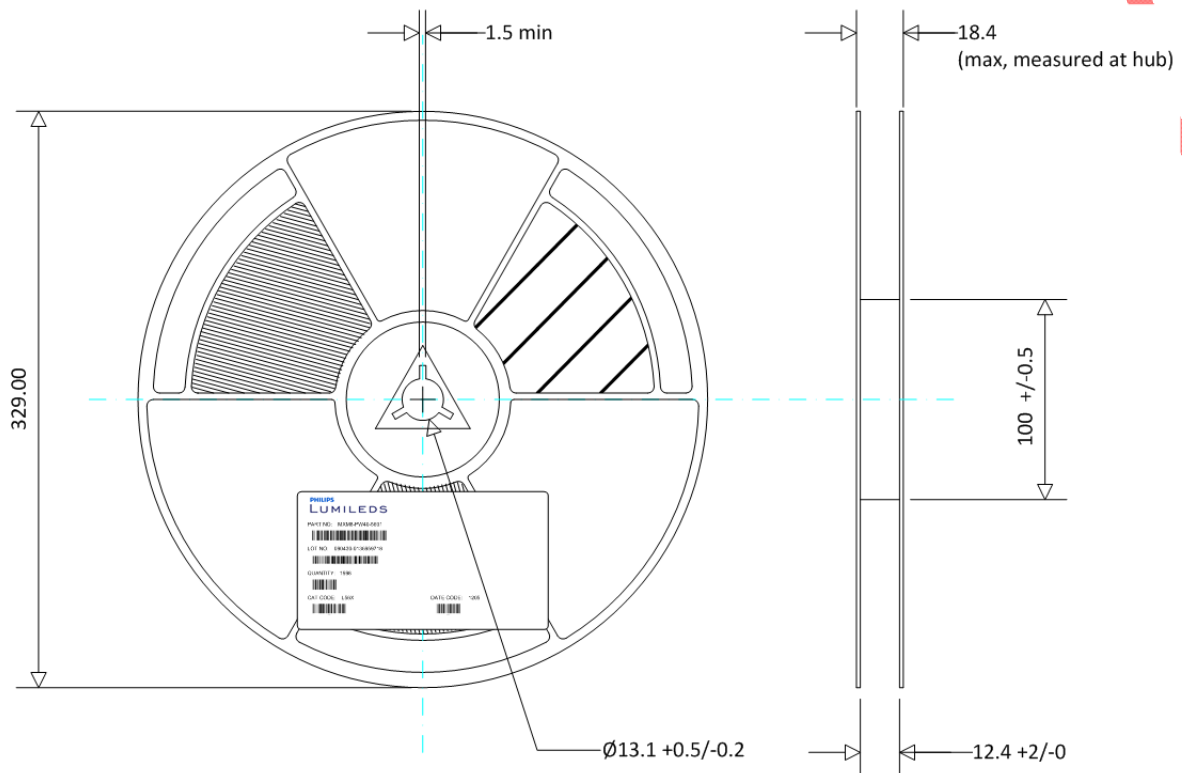

Figure 12.

### Notes for Figure 13:

1. All dimensions are in millimeters
2. Empty component pockets sealed with top cover tape.
3. 13 inch reel-5000 pieces per reel.
4. Minimum packing quantity is 5000 pieces.
5. The maximum number of consecutive missing LEDs is two.
6. In accordance with EIA-481-1-B specification.

# Product Binning and Labeling

## Purpose of Product Binning

In the manufacturing of semiconductor products, there is a variation of performance around the average values given in the technical data sheets. For this reason, Philips Lumileds bins the LED components for luminous flux, color and forward voltage ( $V_f$ ).

## Decoding Product Bin Labeling

LUXEON Mid-Power emitters are labeled using a four digit alphanumeric code (CAT code) depicting the bin values for emitters packaged on a single reel. All emitters packaged within a reel are of the same 3-variable bin combination. Using these codes, it is possible to determine optimum mixing and matching of products for consistency in a given application.

Reels of 2700K, 3000K, 3500K, 4000K, 5000K emitters are labeled with the CAT code following the format below.

ABCD

A = Flux bin (L etc.)

B and C = Color bin (For example E, D, G, H, I, J, K, L, M)

D =  $V_f$  bin

Luminous Flux Bins

Table 7 and Table 8 list the standard photometric luminous flux bins for LUXEON Mid-Power emitters (tested and binned at 15 mA). Although several bins are outlined, product availability in a particular bin varies by production run and by product performance. Not all bins are available in all colors. Please contact your Philips Lumileds representative for the L135-xx80-xBHV-00001 & L135-xx80-xCHV-00001 flux bins.

## Flux Bin Labeling

Table 7. Flux Bin for L135-xx80-0BHV-00001

Bin Code	Minimum Photometric Flux (lm)	Maximum Photometric Flux (lm)
K	28	32
L	32	36
M	36	40
P	40	44
Q	44	48
R	48	52
S	52	56

Note:

1. Tested and binned at 25°C,  $I_f=15\text{mA}$ . Tester tolerance:  $\pm 7.5\%$

## Flux Bins

Table 8. Flux Bin for L135-xx80-0CHV-00001

Bin Code	Minimum Photometric Flux (lm)	Maximum Photometric Flux (lm)
B	60	65
C	65	70
D	70	75
E	75	80
F	80	85
G	85	90
H	90	95

Note:

1. Tested and binned at 25°C, I<sub>f</sub>=15mA. Tester tolerance: ±7.5%

## Forward Voltage Bins

Table 9. V<sub>f</sub> Bin for L135-xx80-0BHV-00001

Bin Code	Minimum Forward Voltage (V)	Maximum Forward Voltage (V)
F	22.0	22.8
G	22.8	23.6
H	23.6	24.4
I	24.4	25.2
J	25.2	26.0

Note:

1. Tested and binned at 25°C, I<sub>f</sub>=15mA.

Table 10. V<sub>f</sub> Bin for L135-xx80-0CHV-00001

Bin Code	Minimum Forward Voltage (V)	Maximum Forward Voltage (V)
L	44.0	45.6
M	45.6	47.2
P	47.2	48.8
Q	48.8	50.4
R	50.4	52.0

Note:

1. Tested and binned at 25°C, I<sub>f</sub>=15mA.



# Color Bin Structure

## L135-2780-0xHV-00001 Color Bin Structure

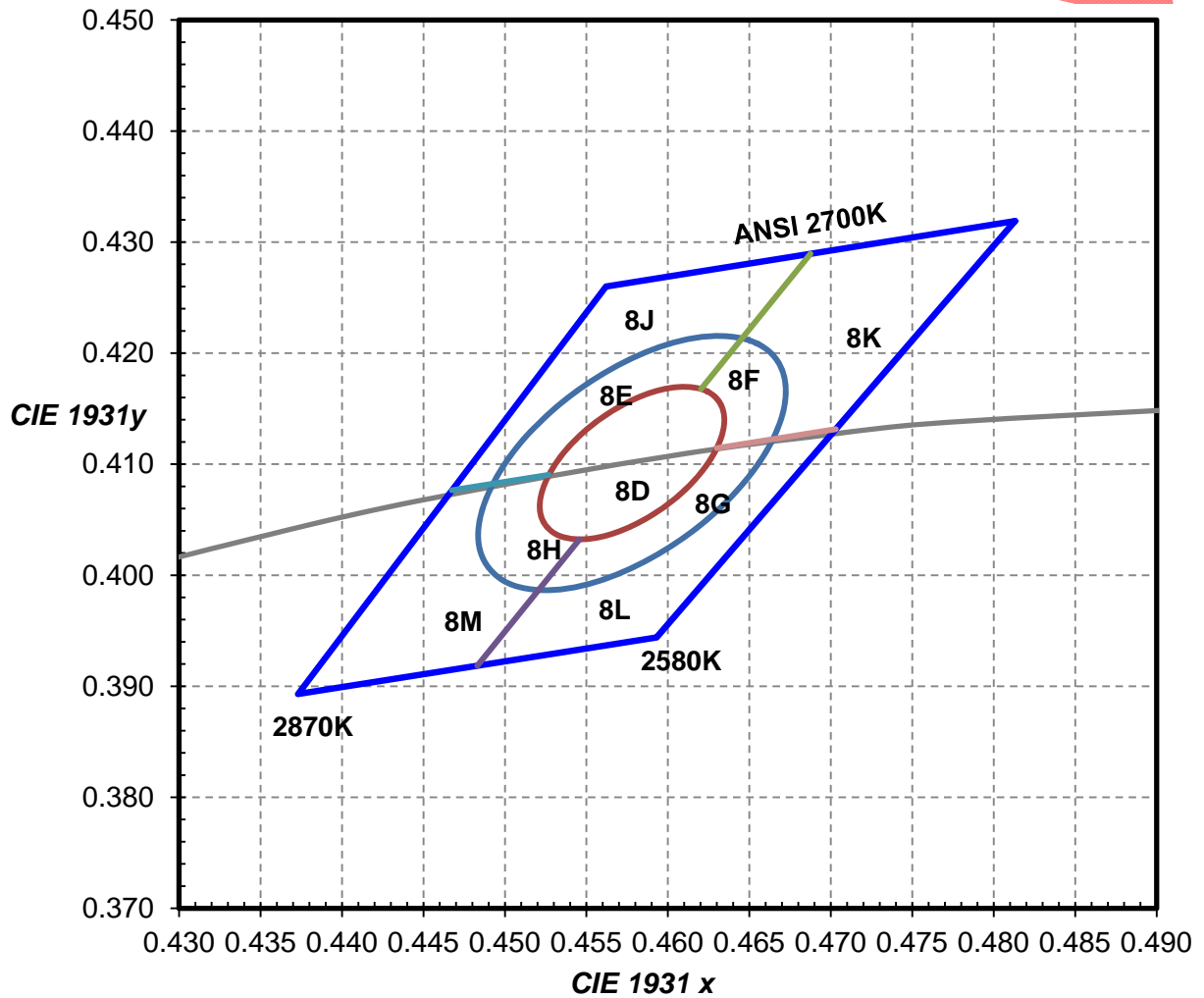

Figure 13. 2700K 1/9<sup>th</sup> color bin structure

Nominal ANSI CCT	Color Space	Target Center Point		Major Axis	Minor Axis	Ellipse Rotation Angle Degree
		cx	cy			
2700K	3 SDCM	0.4578	0.4101	0.00810	0.00420	53.70
2700K	5 SDCM	0.4578	0.4101	0.01350	0.00700	53.70

# L135-3080-0XHV-00001 Color Bin Structure

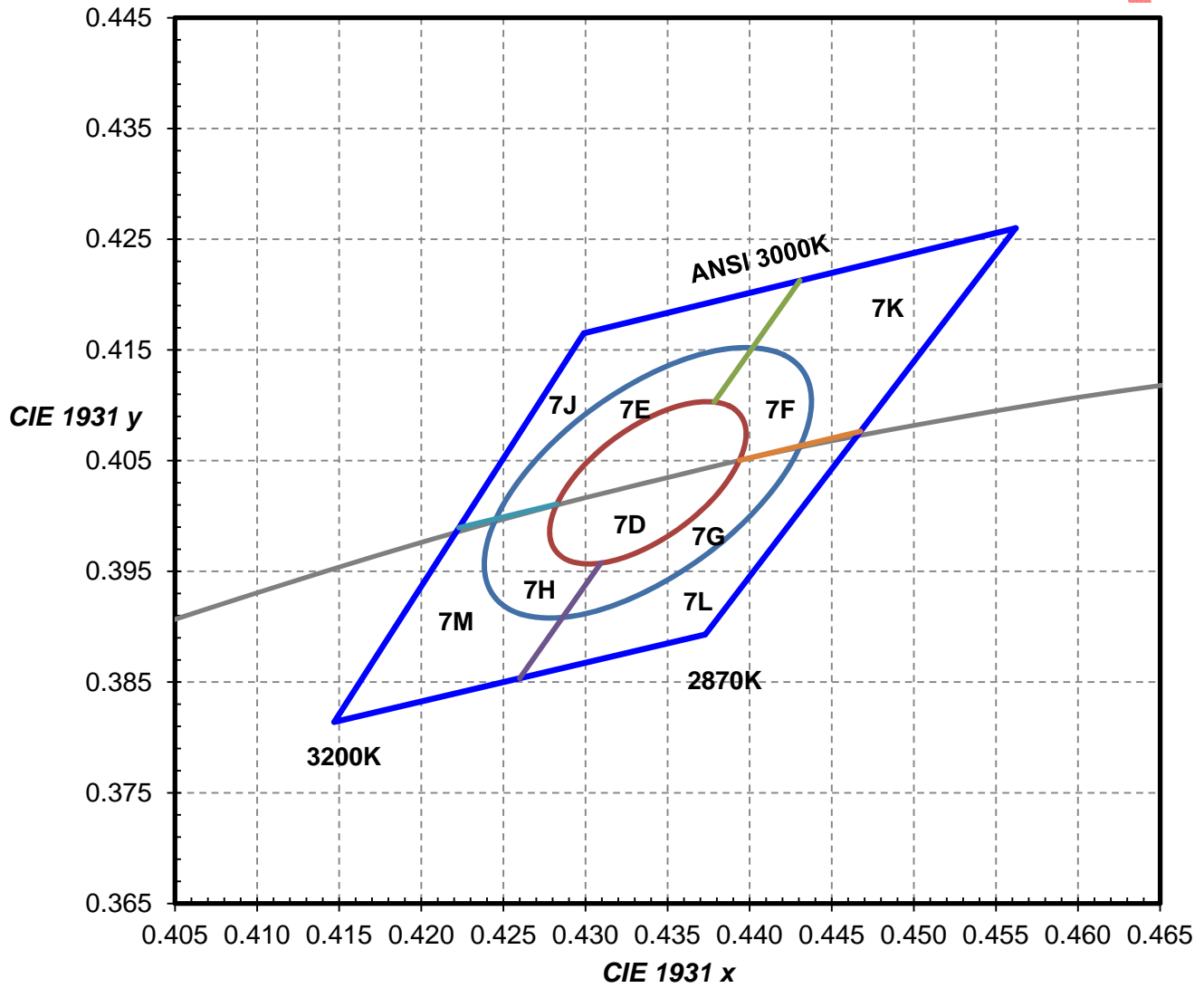

Figure 14. 3000K 1/9<sup>th</sup> color bin structure

Nominal ANSI CCT	Color Space	Target Center Point		Major Axis	Minor Axis	Ellipse Rotation Angle Degree
		cx	cy			
3000K	3 SDCM	0.4338	0.403	0.00834	0.00408	53.22
3000K	5 SDCM	0.4338	0.403	0.01390	0.00680	53.22

# L135-4080-0XHV-00001 Color Bin Structure

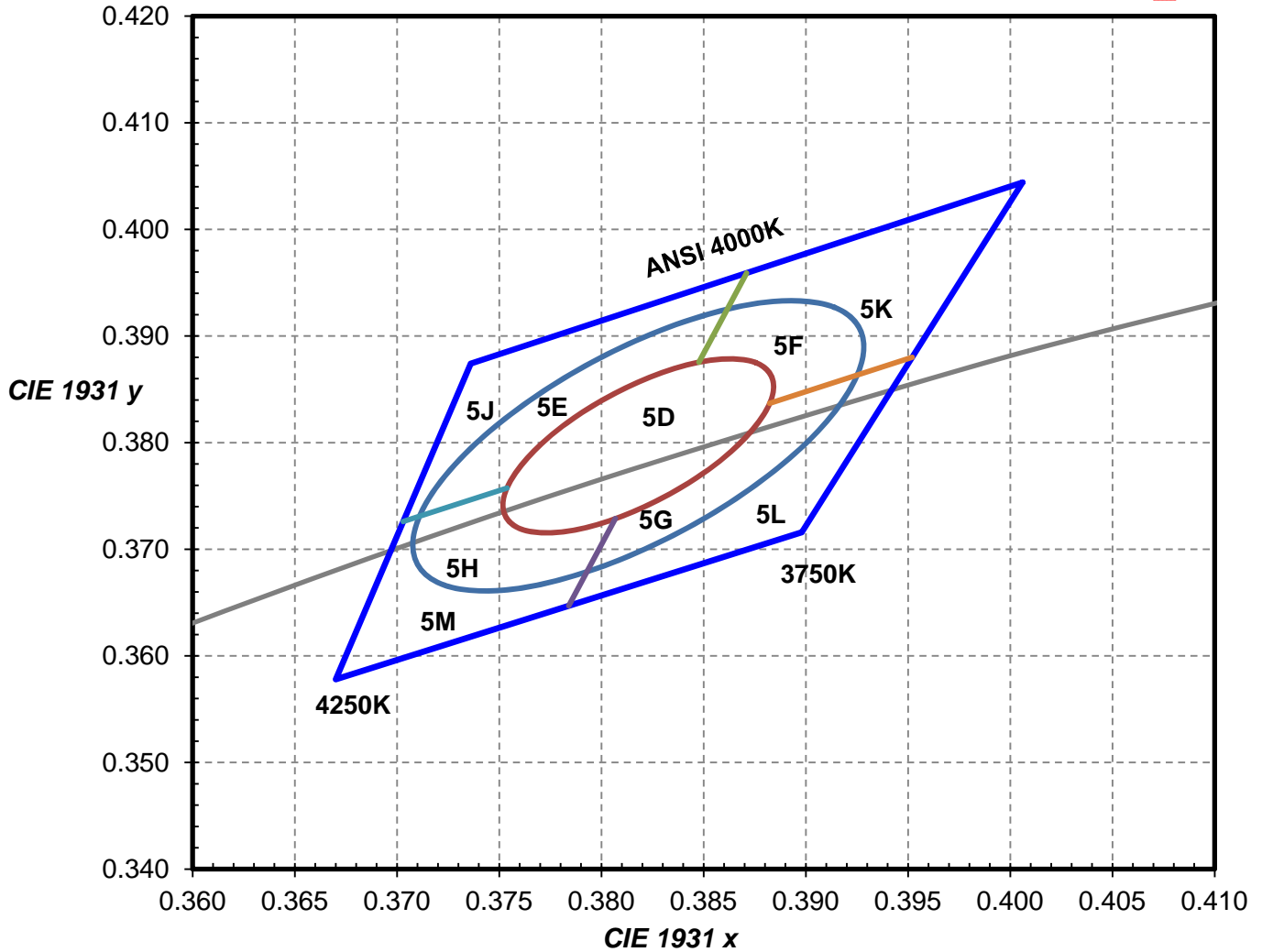

Figure 15. 4000K 1/9<sup>th</sup> color bin structure

Nominal ANSI CCT	Color Space	Target Center Point		Major Axis	Minor Axis	Ellipse Rotation Angle Degree
		cx	cy			
4000K	3 SDCM	0.3818	0.3797	0.00939	0.00402	53.72
4000K	5 SDCM	0.3818	0.3797	0.01565	0.00670	53.72

# L135-5080-0XHV-00001 Color Bin Structure

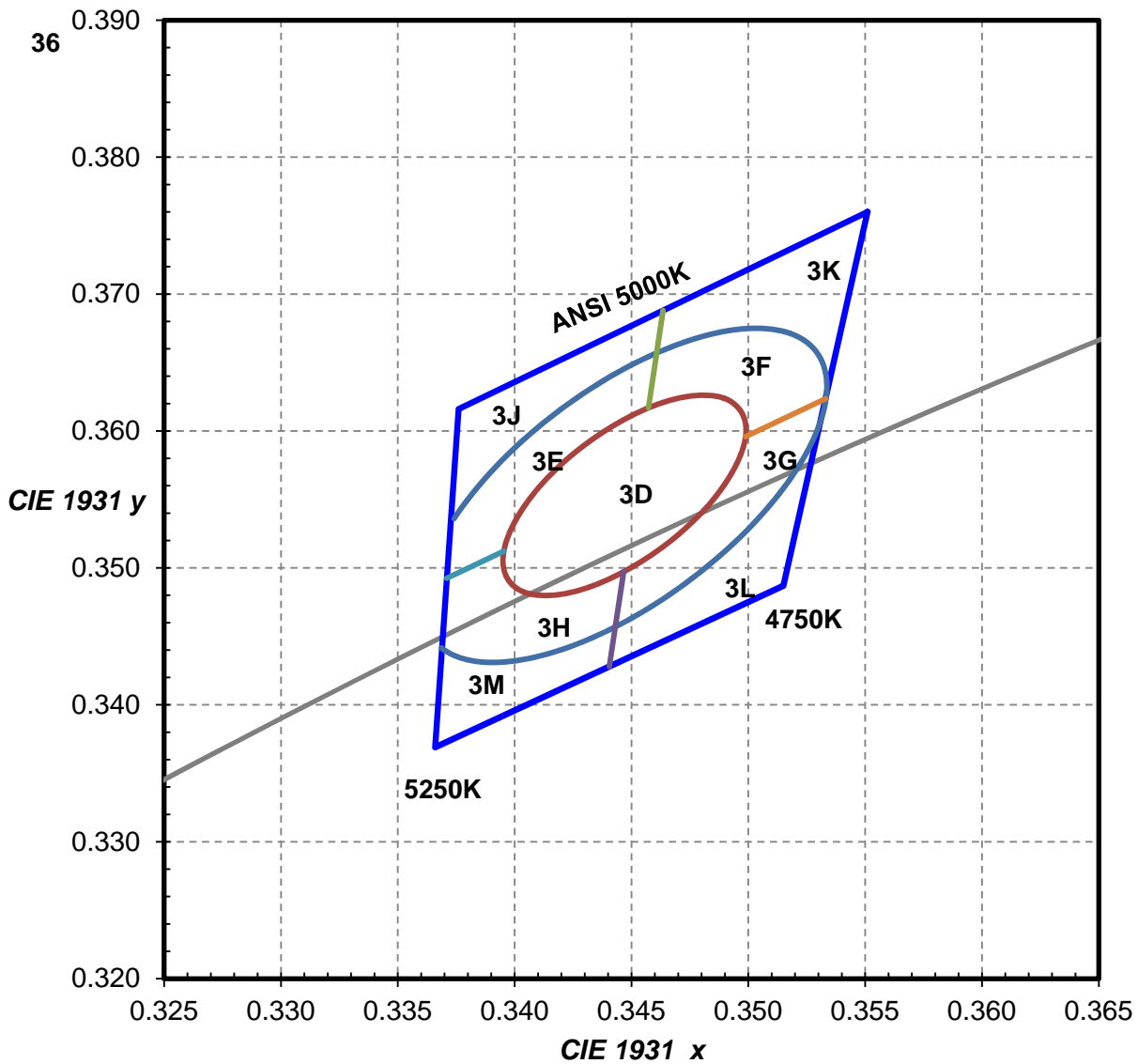

Figure I. 5000K 1/9<sup>th</sup> color bin structure

Nominal ANSI CCT	Color Space	Target Center Point		Major Axis	Minor Axis	Ellipse Rotation Angle Degree
		cx	cy			
5000K	3 SDCM	0.3447	0.3553	0.00822	0.00354	59.62
5000K	5 SDCM	0.3447	0.3553	0.01370	0.00590	59.62

## Who We Are

Philips Lumileds focuses on one goal: Creating the world's highest performing LEDs. The company pioneered the use of solid-state lighting in breakthrough products such as the first LED backlit TV, the first LED flash in camera phones, and the first LED daytime running lights for cars. Today we offer the most comprehensive portfolio of high quality LEDs and uncompromising service.

Philips Lumileds brings LED's qualities of energy efficiency, digital control and long life to spotlights, downlights, high bay and low bay lighting, indoor area lighting, architectural and specialty lighting as well as retrofit lamps. Our products are engineered for optimal light quality and unprecedented efficacy at the lowest overall cost. By offering LEDs in chip, packaged and module form, we deliver supply chain flexibility to the inventors of next generation illumination.

Philips Lumileds understands that solid state lighting is not just about energy efficiency. It is about elegant design. Reinventing form. Engineering new materials. Pioneering markets and simplifying the supply chain. It's about a shared vision. Learn more about our comprehensive portfolio of LEDs at [www.philipslumileds.com](http://www.philipslumileds.com).

Philips Lumileds Lighting Company shall not be liable for any kind of loss of data or any other damages, direct, indirect or consequential, resulting from the use of the provided information and data. Although Philips Lumileds Lighting Company has attempted to provide the most accurate information and data, the materials and services information and data are provided "as is" and Philips Lumileds Lighting Company neither warranties, nor guarantees the contents and correctness of the provided information and data. Philips Lumileds Lighting Company reserves the right to make changes without notice. You as user agree to this disclaimer and user agreement with the download or use of the provided materials, information and data.



©2013 Philips Lumileds Lighting Company. All rights reserved.  
LUXEON is a registered trademark of the Philips Lumileds Lighting Company in the United States and other countries.

[www.philipslumileds.com](http://www.philipslumileds.com)  
[www.philipslumileds.cn.com](http://www.philipslumileds.cn.com)

**PHILIPS**  
**LUMILEDS**

