

Molding Type Power Inductor

ASPI-0630HI



RoHS
Compliant



7.2 x 6.65 x 3.0 mm

FEATURES:

- High saturation current.
- Low loss due to low DC resistance.
- Frequency application up to 3MHz.
- Low profile with max thickness 3.0mm.
- 100% lead free and metted RoHS standard.
- Suitable for reflow soldering.
- High reliable SMD package

APPLICATIONS:

- DC/DC converters in Notebook, Netbook, desktop and server
- Low profile, high current power supplies.

STANDARD SPECIFICATIONS

Abrakon P/N:	ASPI-0630HI Series
Operating Temperature & Humidity:	-55°C to +125°C (Including self generated heat)
Storage Temperature & Humidity:	+25°C to +35°C, 45% to 85% RH

Part Number	Inductance	Tolerance	DCR Typ	DCR Max	Saturation Current	Temperature Rise Current
Units	μH	%	mΩ	mΩ	A	A
Symbol	L	M			Isat	Irms
ASPI-0630HI-1R0	1.0	M	9.0	10.0	20.5	11.0
ASPI-0630HI-1R5	1.5	M	14.0	15.0	17.0	9.0
ASPI-0630HI-2R2	2.2	M	18.0	20.0	14.0	8.0
ASPI-0630HI-3R3	3.3	M	28.0	30.0	13.5	6.8
ASPI-0630HI-4R7	4.7	M	37.0	40.0	10.0	5.5
ASPI-0630HI-6R8	6.8	M	54.0	60.0	8.0	4.5
ASPI-0630HI-100	10.0	M	102.0	105.0	7.0	3.0

Test Conditions

Inductance is measured in HP-4285A Precision LCR Meter.

RDC is measured in HP-4338B milli ohm meter.(or equivalent).

Isat: Based on inductance change ($\Delta L/L_0 : \leq -20\%$)

Irms: Based on temperature rise ($\Delta T : 40^\circ\text{C TYP.}$)

ELECTRICAL CHARACTERISTIC CU

ASPI-0630HI-1R0

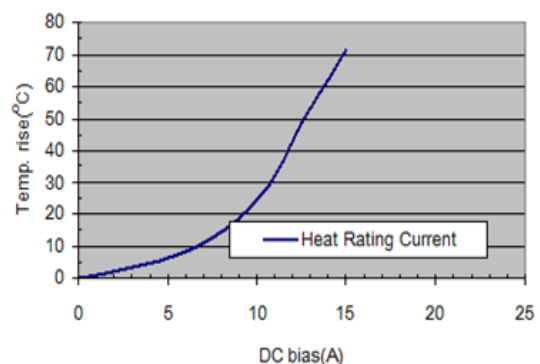
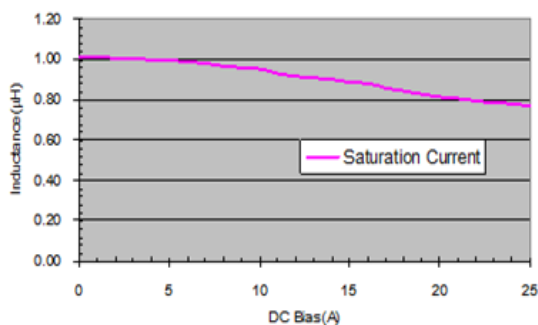

Molding Type Power Inductor

ASPI-0630HI



7.2 x 6.65 x 3.0 mm

ELECTRICAL CHARACTERISTIC CURVES

ASPI-0630HI-1R5

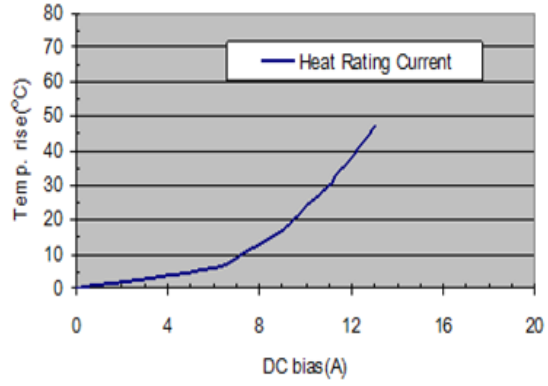
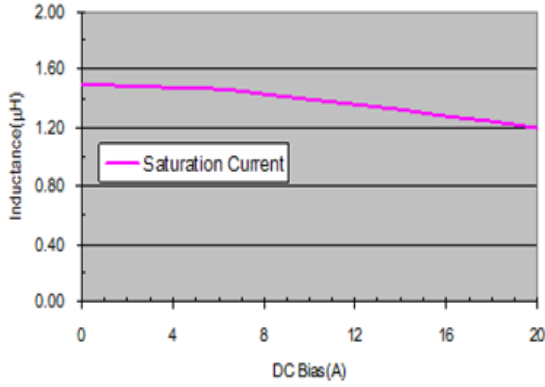

ASPI-0630HI-2R2

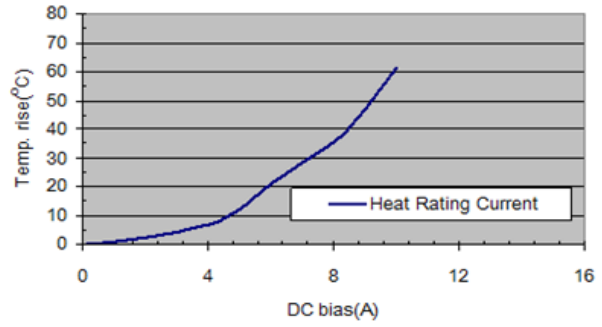
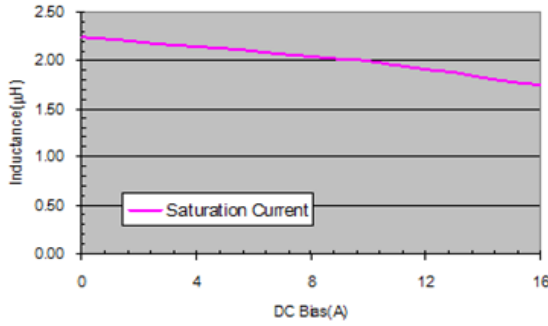

ASPI-0630HI-3R3

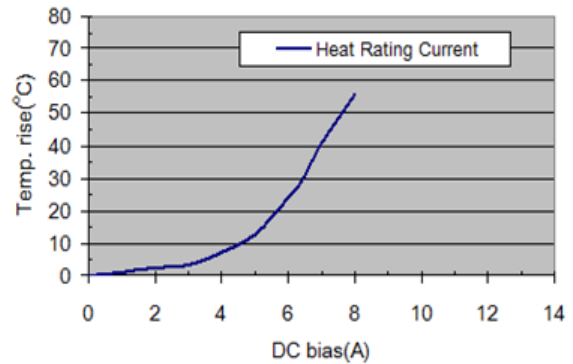
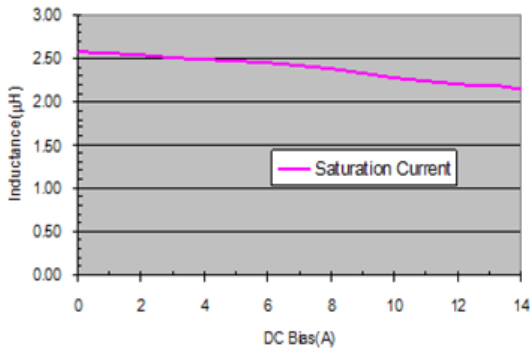

Molding Type Power Inductor

ASPI-0630HI



RoHS
Compliant



7.2 x 6.65 x 3.0 mm

ELECTRICAL CHARACTERISTIC CURVES

ASPI-0630HI-4R7

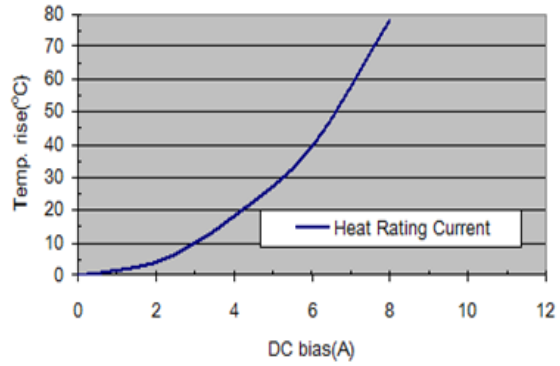
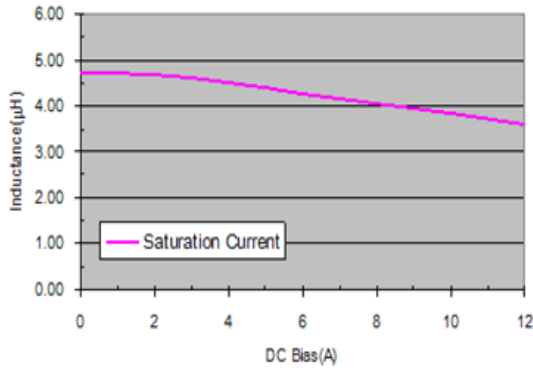

ASPI-0630HI-6R8

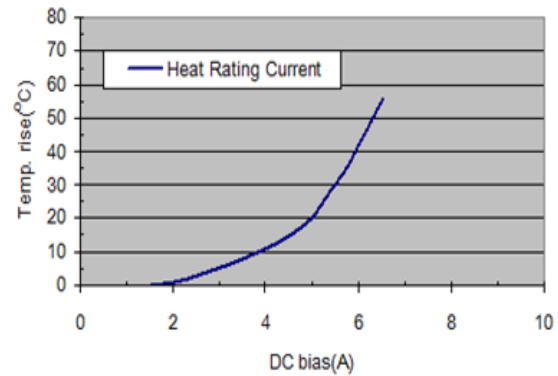
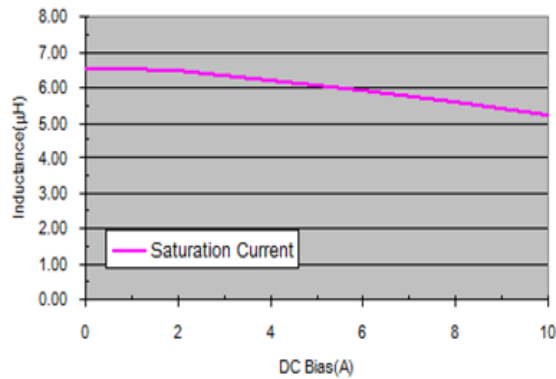

ASPI-0630HI-100

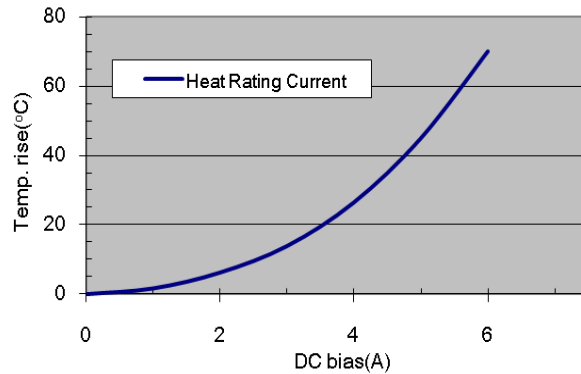
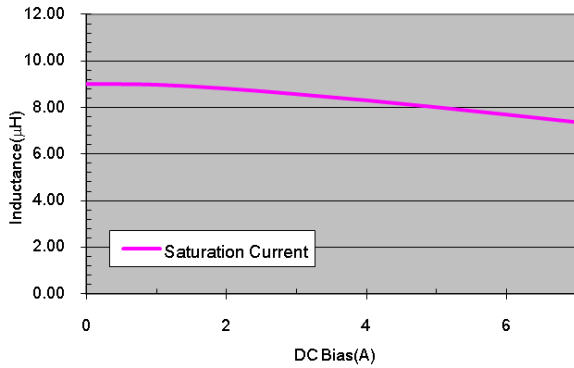

Molding Type Power Inductor

ASPI-0630HI



RoHS
Compliant



7.2 x 6.65 x 3.0 mm

PART NUMBER IDENTIFICATION

ASPI-0630HI- -

Inductance Code

Please refer to the
Electrical Spec Table

Tolerance

M: $\pm 20\%$

Packaging

T15: Tape and Reel (1.5kpcs /
reel)

OUTLINE DRAWING:

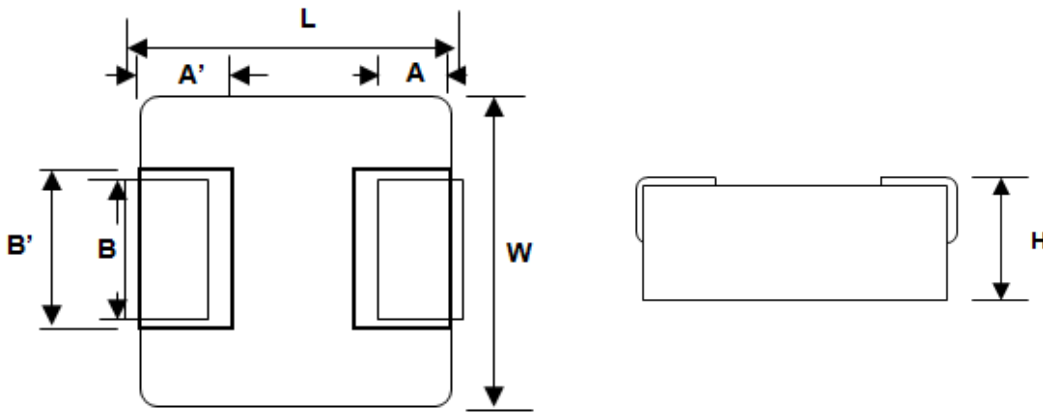

A	A'	B	B'	L	W	H max
1.6 \pm 0.4	2.0 \pm 0.1	3.0 \pm 0.3	3.4 \pm 0.2	7.2 \pm 0.3	6.65 \pm 0.2	3.0

Recommended Land Pattern

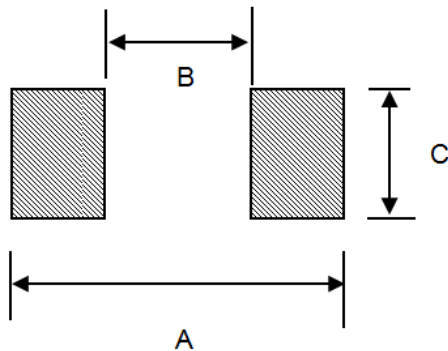

A	B	C
8.4	3.7	3.4

Dimension: mm

Molding Type Power Inductor

ASPI-0630HI



RoHS
Compliant



7.2 x 6.65 x 3.0 mm

TAPE & REEL:

T1: 1,500pcs / reel

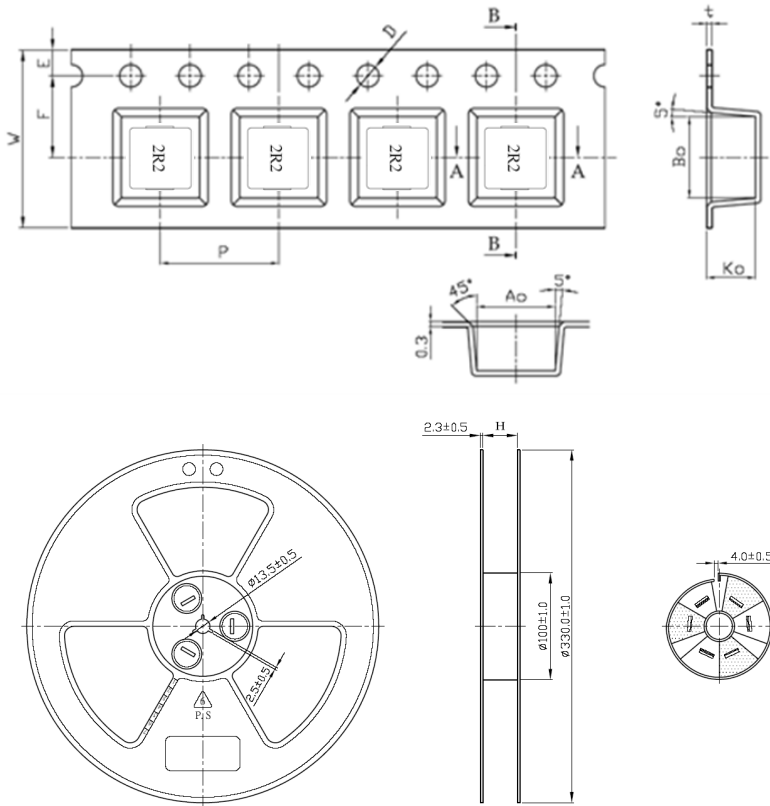

A0	7.2
B0	7.5
K0	3.6
P	12.0
t	0.3
W	16
E	1.75
F	7.5
D	1.5

Dimension: mm

REFLOW PROFILE:

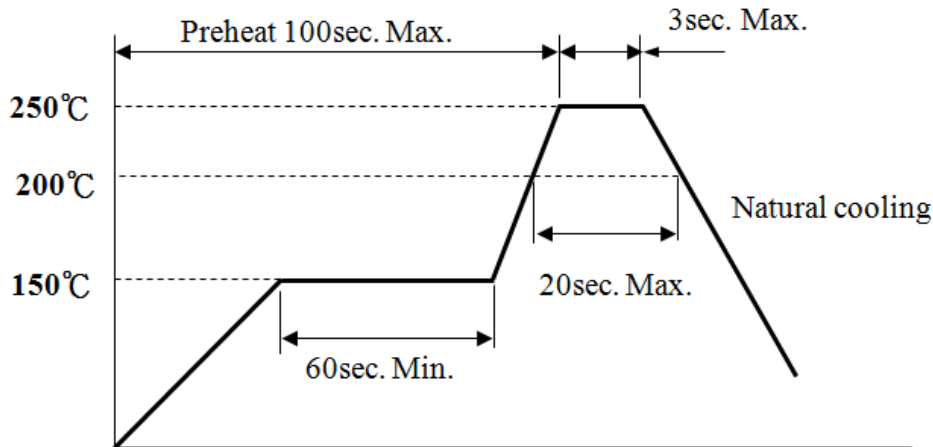

ATTENTION: Abracon Corporation's products are COTS – Commercial-Off-The-Shelf products; suitable for Commercial, Industrial and, where designated, Automotive Applications. Abracon's products are not specifically designed for Military, Aviation, Aerospace, Life-dependant Medical applications or any application requiring high reliability where component failure could result in loss of life and/or property. For applications requiring high reliability and/or presenting an extreme operating environment, written consent and authorization from Abracon Corporation is required. Please contact Abracon Corporation for more information.

ABRACON IS
ISO 9001:2008
CERTIFIED



Visit www.abracon.com for Terms & Conditions of Sale
30332 Esperanza, Rancho Santa Margarita, California 92688
tel 949-546-8000 | fax 949-546-8001 | www.abracon.com

Revised: 11.17.11