

Driver LCO 50W 700/1050/1250/1400/2100mA 0-10V C ADV UNV
OUTDOOR advanced series

**Product description**

- _ Constant current LED Driver
- _ Only for US applications
- _ Dimmable via 0 ... 10 V interface
- _ Dimming range 10 to 100 %
- _ Class 2 power supply (not the 700 mA version)
- _ FCC Part 15
- _ Type HL rated for hazardous location
- _ Dry and damp location
- _ Max. output power 50 W
- _ Up to 86 % efficiency
- _ Nominal lifetime up to 100,000 h
- _ 5 years guarantee

Housing properties

- _ Casing: polycarbonate, black
- _ Potted style
- _ Type of protection IP66

Functions

- _ Over voltage protection
- _ Short-circuit protection
- _ No-load protection

Typical applications

- _ For wall pack and outdoor general illumination

Website

<http://www.tridonic.us/28002152>



Spotlights



Downlights



Linear



Area



Floor | Wall



Free-standing



Street



Decorative

Driver LCO 50W 700/1050/1250/1400/2100mA 0-10V C ADV UNV
OUTDOOR advanced series

The complete data sheet for this product is available in the Downloads section.

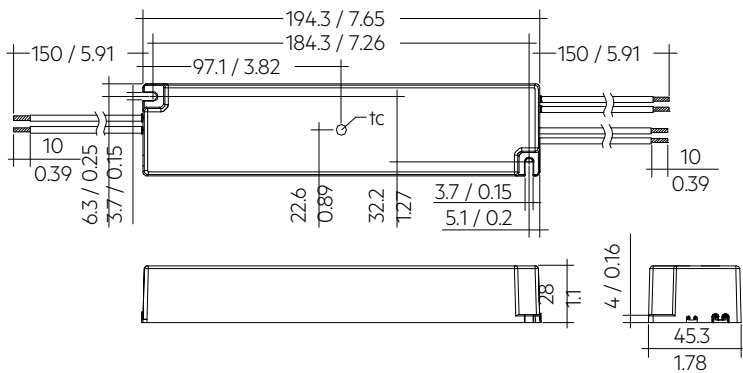

Dimensions in mm / inch

Approval marks



Standards

UL 8750, UL 1310, FCC PART 15, ANSI C62.41, ANSI C63.4, UL 1012, NEMA 4, CSA C22.2