

## High Voltage and ESD Protection Bipolar Hall-Effect Digital Position Sensor ICs: SS41K6

**005990**

Issue 2

Datasheet

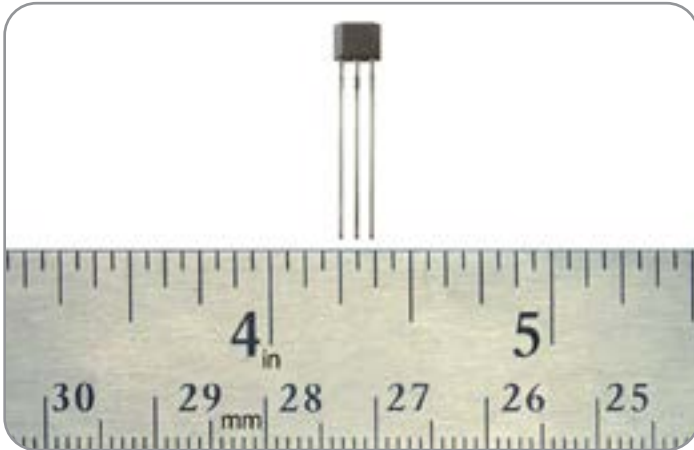

### DESCRIPTION

The SS41K6 sensor ICs are versatile digital Hall-effect devices operated by the magnetic field from a permanent magnet or an electromagnet, and are designed to respond to alternating North and South poles. The built-in regulator provides enhanced operation stability from 4.5 Vdc to 60 Vdc supply voltage range, and internal circuitry is designed to prevent sensor damage in case the supply voltage polarity is accidentally reversed. Output short circuit protection is enabled when the output load current exceeds the rated load current specified in Table 1. The open-collector, sinking output voltage can be easily interfaced with a wide variety of electronic circuits. These products are available in a flat TO-92-style package with straight leads in bulk packaging.

### FEATURES

- ESD protected +16 kV (HBM - Human Body Model)
- Enhanced supply voltage range of 4.5 Vdc to 60 Vdc allows use in a wide variety of applications
- Current consumption of only 5 mA max. at 4.5 Vdc provides energy efficiency
- Output short circuit protection
- Bipolar magnetics for ring magnet applications with alternating North and South poles
- Temperature range of -40°C to 150°C [-40°F to 302°F]
- RoHS-compliant materials meet Directive 2002/95/EC
- Small, leaded, flat TO-92-style package allows for a compact PCB layout

### POTENTIAL APPLICATIONS

- **Transportation:** Speed and RPM sensing, electric motor commutation and control
- **Industrial and Commercial:** Flow-rate sensing for appliances, tachomotor counter pickup, brushless dc motor commutation, motor and fan control
- **Medical:** Equipment or instruments that use electric motors

### PORTFOLIO

Other bipolar digital position sensor ICs include:

- SS30AT, SS40A, SS50AT
- SS311PT, SS411P
- SS40F, SS40AF
- SS400 Series, SS500 Series (selected catalog listings)
- SS41, SS41-L, SS41-T2, SS41-T3, SS41-S, SS41-SP
- SS51T

# Bipolar Hall-Effect Digital Position Sensor ICs:

SS41K6

**Table 1. Performance Specifications (At  $V_S = 4.5\text{ V}$  to  $60\text{ V}$ ,  $T_A = -40^\circ\text{C}$  to  $150^\circ\text{C}$  [ $-40^\circ\text{F}$  to  $302^\circ\text{F}$ ],  $I_O = 15\text{ mA}$ , except where otherwise specified.)**

Characteristic	Symbol	Condition	Min.	Typ.	Max.	Unit
Supply voltage	$V_S$	-	4.5	-	60.0	V
Supply current	$I_S$	-	-	3.6	10.0	mA
Output voltage (ON)	$V_{SAT}$	$I_O = 15\text{ mA}$	-	0.215	0.600	V
Output leakage current	$I_{OH}$	-	-	-	10.0	$\mu\text{A}$
Output current limit <sup>1</sup>	$I_{O(SCP)}$	short circuit protection <sup>1</sup>	40	-	-	mA
Output switching time: rise time	$t_r$	$T_A = 25^\circ\text{C}$ [ $77^\circ\text{F}$ ]	-	-	1.5	$\mu\text{s}$
fall time	$t_f$	$T_A = 25^\circ\text{C}$ [ $77^\circ\text{F}$ ]	-	-	1.5	$\mu\text{s}$
ESD (Human Body Model)	$V_{ESD}$	per JEDEC JS-001-2014	-16	-	16	kV
Operating temperature	$T_A$	-	-40 [-40]	-	150 [302]	$^\circ\text{C}$ [ $^\circ\text{F}$ ]
Junction temperature	$T_J$	-	-40 [-40]	-	165 [329]	$^\circ\text{C}$ [ $^\circ\text{F}$ ]
Storage temperature	$T_S$	-	-40 [-40]	-	150 [302]	$^\circ\text{C}$ [ $^\circ\text{F}$ ]
Thermal resistance	$R_{\theta JA}$	-	-	-	233	$^\circ\text{C}/\text{W}$
Soldering time and temperature	-	3 s max.	250 [482]	-	260 [500]	$^\circ\text{C}$ [ $^\circ\text{F}$ ]

<sup>1</sup> Output short circuit protection is enabled when the output load current exceeds the rated load current.

**Table 2. Magnetic Characteristics (At  $V_S = 4.5\text{ V}$  to  $60\text{ V}$ ,  $T_A = -40^\circ\text{C}$  to  $150^\circ\text{C}$  [ $-40^\circ\text{F}$  to  $302^\circ\text{F}$ ], except where otherwise specified.)**

Characteristic	Symbol	Condition	Min.	Typ.	Max.	Unit
Operate	$B_{OP}$	- $T_A = 25^\circ\text{C}$ [ $75^\circ\text{F}$ ]	-	25	115	Gauss
Release	$B_{RP}$	- $T_A = 25^\circ\text{C}$ [ $75^\circ\text{F}$ ]	-115	-25	-	Gauss
Differential	$B_{DIF}$	-	30	-	-	Gauss

## NOTICE

These Hall-effect sensor ICs may have an initial output in either the ON or OFF state if powered up with an applied magnetic field in the differential zone (applied magnetic field  $>B_{RP}$  and  $<B_{OP}$ ). Honeywell recommends allowing 10  $\mu\text{s}$  after supply voltage has reached 4.5 V for the output voltage to stabilize.

## NOTICE

The magnetic field strength (Gauss) required to cause the switch to change state (operate and release) will be as specified in the magnetic characteristics (see Table 2). To test the switch against the specified limits, the switch must be placed in a uniform magnetic field.

**CAUTION**

ELECTROSTATIC SENSITIVE DEVICES  
DO NOT OPEN OR HANDLE EXCEPT AT A STATIC FREE WORKSTATION

**ESD SENSITIVITY: CLASS 3B**

**Table 3. Absolute Maximum Specifications**

Characteristic	Symbol	Condition	Min.	Typ.	Max.	Unit
Supply voltage	$V_S$	-	-0.5	-	60.0	V
Output voltage	$V_O$	-	-0.5	-	60.0	V
Output current	$I_O$	-	-	-	N/A <sup>1</sup>	mA
Magnetic flux	$B$	-	-	-	no limit	Gauss

<sup>1</sup> Output short circuit protection is enabled when the output load current exceeds the rated load current shown in Table 1.

## NOTICE

Absolute maximum ratings are the extreme limits the device will momentarily withstand without damage to the device. Electrical and mechanical characteristics are not guaranteed if the rated voltage and/or currents are exceeded, nor will the device necessarily operate at absolute maximum ratings.

# Bipolar Hall-Effect Digital Position Sensor ICs:

SS41K6

**Figure 1. Magnetic Characteristics vs Temperature**

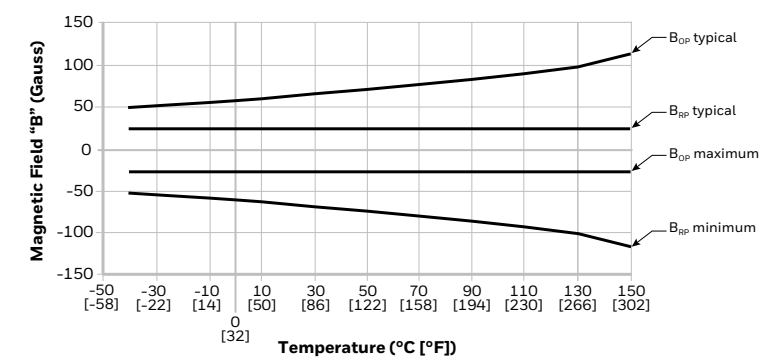

**Figure 2. Power Derating Curve**

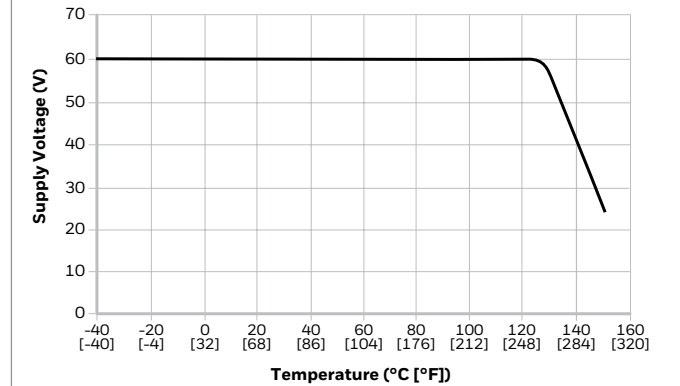

**Figure 3. Transfer Characteristics**

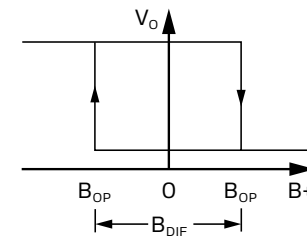

**Figure 4. Transfer Characteristics Definition**

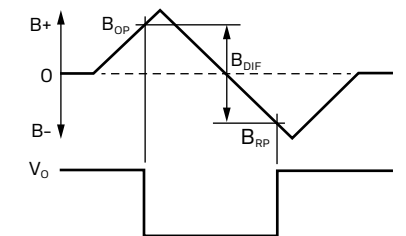

**Figure 5. Current Sinking Output Block Diagram**

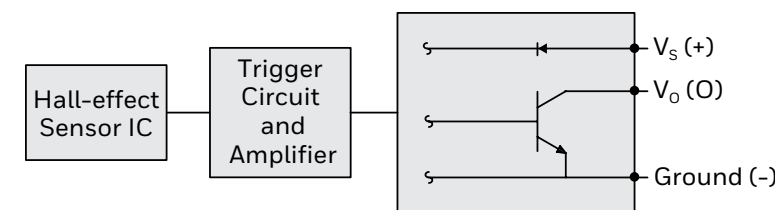

**Figure 6. Basic Application Circuit**

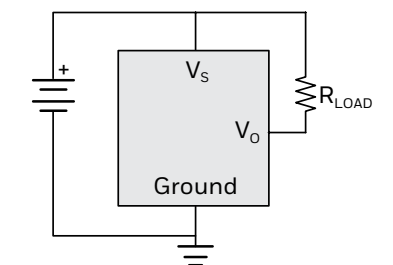

**Figure 7. Wiring Diagrams**

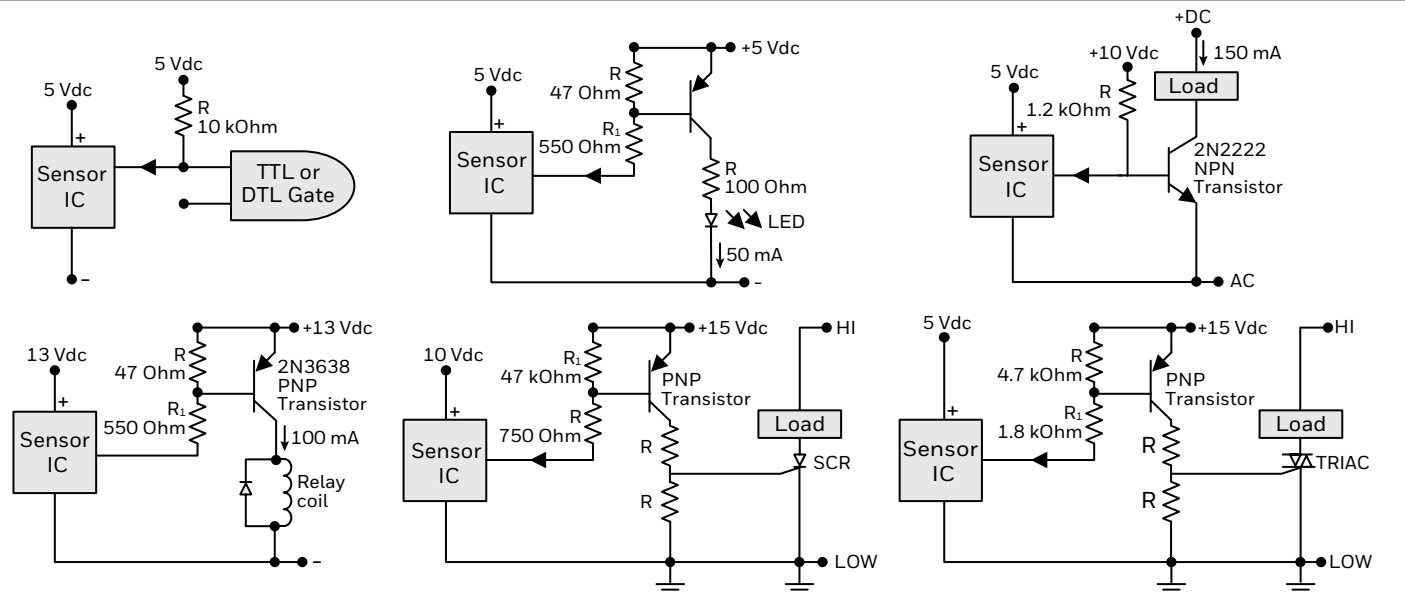

# Bipolar Hall-Effect Digital Position Sensor ICs:

SS41K6

Figure 8. Mounting and Dimensional Drawings (For reference only: mm/[in])

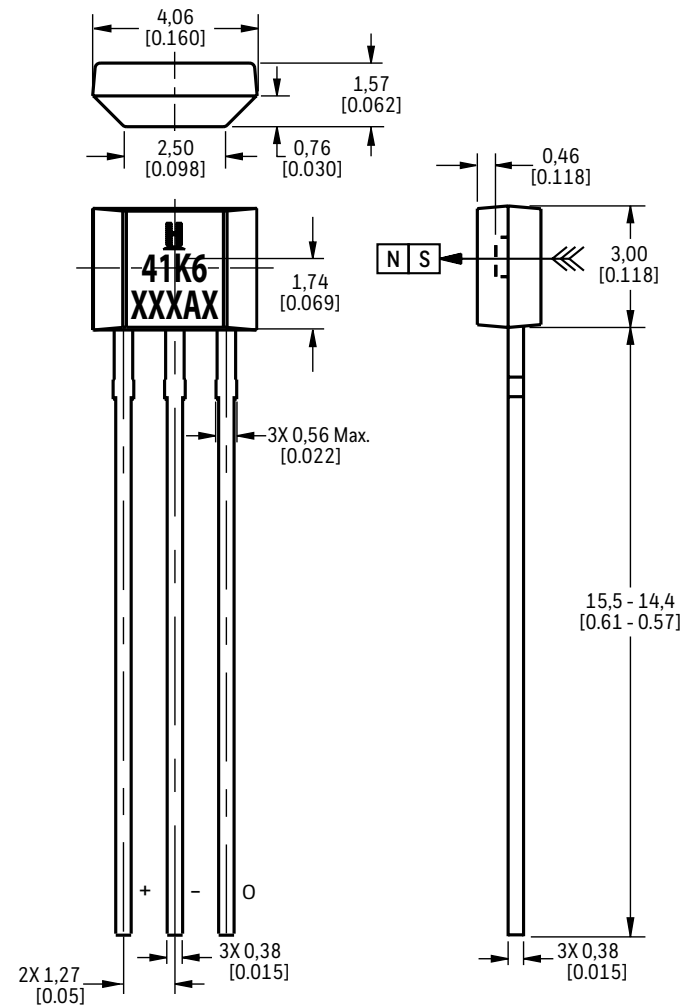

Note: Ensure the minimum hole size in the PCB is 0,68 mm [0.027] dia. based on the IPC 2222 Level B standard.

Table 4. Order Guide

Catalog Listing	Description
SS41K6	Bipolar Hall-Effect Digital Position Sensor, 4.5 Vdc to 60 Vdc supply voltage range, flat TO-92-style, straight standard leads, bulk pack, 1000 units/bag



## ADDITIONAL INFORMATION

The following associated literature is available on the Honeywell web site at [sensing.honeywell.com](http://sensing.honeywell.com):

- Product Line Guide
- Product Range Guide
- Selection Guides

## ⚠ WARNING PERSONAL INJURY

DO NOT USE these products as safety or emergency stop devices or in any other application where failure of the product could result in personal injury.

**Failure to comply with these instructions could result in death or serious injury.**

## ⚠ WARNING MISUSE OF DOCUMENTATION

- The information presented in this datasheet is for reference only. Do not use this document as a product installation guide.
- Complete installation, operation, and maintenance information is provided in the instructions supplied with each product.

**Failure to comply with these instructions could result in death or serious injury.**

## Warranty/Remedy

Honeywell warrants goods of its manufacture as being free of defective materials and faulty workmanship during the applicable warranty period. Honeywell's standard product warranty applies unless agreed to otherwise by Honeywell in writing; please refer to your order acknowledgment or consult your local sales office for specific warranty details. If warranted goods are returned to Honeywell during the period of coverage, Honeywell will repair or replace, at its option, without charge those items that Honeywell, in its sole discretion, finds defective.

**The foregoing is buyer's sole remedy and is in lieu of all other warranties, expressed or implied, including those of merchantability and fitness for a particular purpose. In no event shall Honeywell be liable for consequential, special, or indirect damages.**

While Honeywell may provide application assistance personally, through our literature and the Honeywell web site, it is buyer's sole responsibility to determine the suitability of the product in the application. Specifications may change without notice. The information we supply is believed to be accurate and reliable as of this writing. However, Honeywell assumes no responsibility for its use.

## For more information

Honeywell Advanced Sensing Technologies services its customers through a worldwide network of sales offices and distributors. For application assistance, current specifications, pricing or the nearest Authorized Distributor, visit [sps.honeywell.com/ast](http://sps.honeywell.com/ast) or call:

Asia Pacific +65 6355-2828  
Europe +44 (0) 1698 481481  
USA/Canada +1-800-537-6945

## Honeywell Advanced Sensing Technologies

830 East Arapaho Road  
Richardson, TX 75081  
[sps.honeywell.com/ast](http://sps.honeywell.com/ast)

005990-2-EN | 2 | 05/21  
© 2021 Honeywell International Inc. All rights reserved.

**Honeywell**