

APPROVED: _____
 DATE: _____ TITLE: _____

Rev	AWO #	Description	Date	Appr
-		RELEASED	11/20/19	
A		UPDATE DRAWING	6/11/20	AY/RC
B		ADDED PACKING	11/9/20	OW/RC

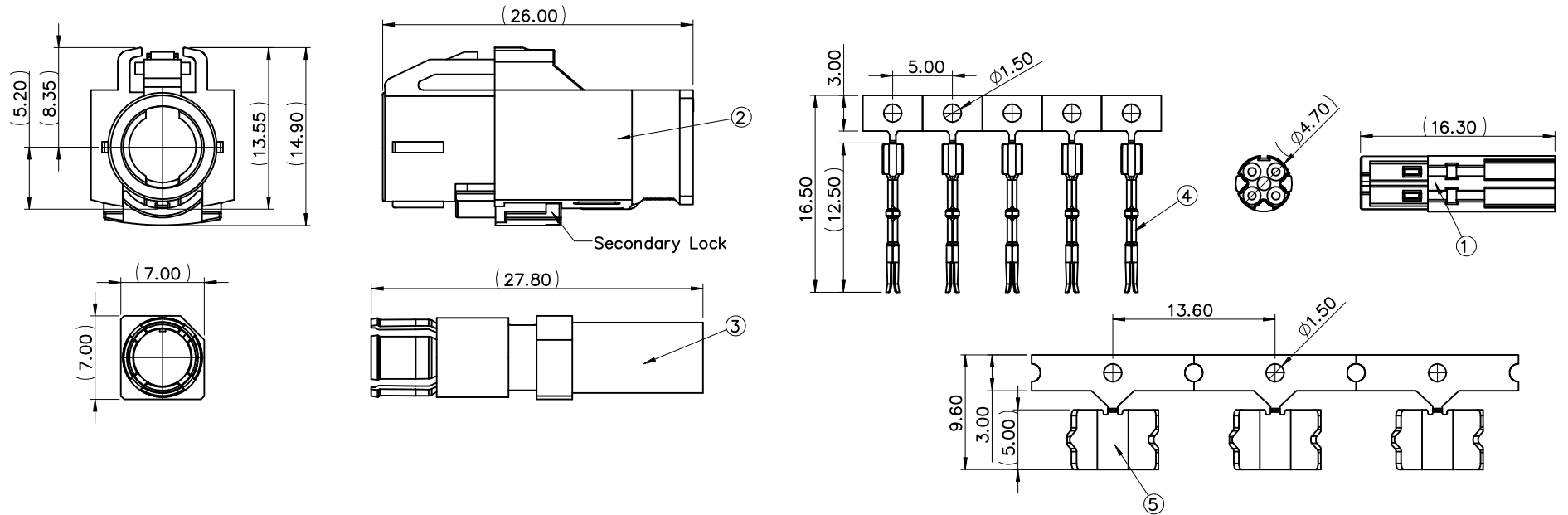

SPECIFICATIONS:

Material:
 Insulator: PBT, rated UL 94V-0, Color: Black
 Contacts: Phosphor Bronze
 Contact Sleeve: Phosphor Bronze
 Outer Contacts: Brass
Plating:
 6u" Gold over Nickel underplate on contact area,
 Tin over Copper underplate on solder tails
Electrical:
 Impedance, differential mode: 100 ohms differential signalling, for one pair
 or quad cable shielded

Frequency: DC to 2.0 GHz
 Return loss: ≥ 20 dB to 1.0GHz
 ≥ 17 dB to 2.0GHz
 Insertion loss: ≤ 0.1 dB @ 1.0GHz
 Insulation resistance: 1,000 Mohms min
 Signal contact resistance: 10 Mohms max
Mechanical:
 Mating Cycles: ≥ 25 Cycles
 Engagement force: ≤ 30 N
 Disengagement force: ≥ 5 N
 Retention force latch: ≥ 110 N
 Coding efficiency: ≥ 80 N
 Temperature Rating:
 -40°C to +105°C
Environmental:
 Lead free, RoHS compliant



MATERIALS AND FINISHES

Item	Part Name	Material	Finishes	Qty
1	Inner Housing	PBT	White	1
2	Shroud with TPA	PBT	See Table	1
2-1	Coding Housing			
2-2	Secondary Lock			
3	Shell Sub- Assembly	Brass & Phosphor Bronze	50u"~200u" Nickel	1
3-1	Machining Shell			
3-2	Front Spring			
4	Center Contact	Corrosion Copper	Contact Area: 6u" Gold Solder Area: 40u"~150u" Tin	4
5	Cable Clip	Brass	100u"~200u" Tin	1

UNLESS OTHERWISE SPECIFIED
 ALL DIMENSIONS ARE MILLIMETERS
 TOLERANCES: EXCEPT AS NOTED
 ANGLE
 MM
 .X. ± 0.50
 .X ± 0.30
 .XX ± 0.20
 $\pm 5^\circ$



909 Rahway Avenue,
 Union, NJ 07083
 Phone: 908-687-5000
 Fax: 908-687-5710

TITLE
 HSD FAKRA SOLDER CABLE SOCKET WITH
 4P CRIMP HOUSING

APPROVALS		DATE
DRAWN	OW	11/20/19
CHECKED	AC	11/20/19
APPROVED		

SIZE	PART NO.	REV.
X	HSD-04X-S-SD-SG-C4	B
REF: S00013T	SCALE: NTS	SHEET 1 OF 3

6

5

4

3

2

1

APPROVED: _____

DATE: _____ TITLE: _____

Rev	AWO #	Description	Date	Appr
-----	-------	-------------	------	------

SEE SHT 1 OF 3 FOR REVISION

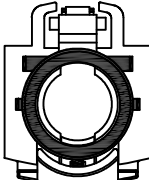
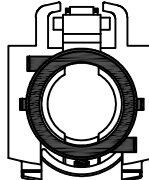
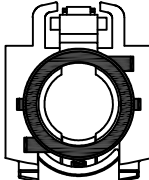
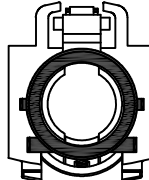
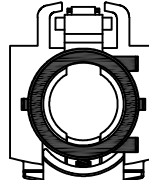
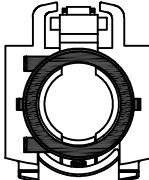
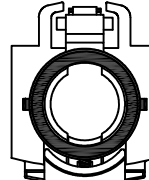
Coding	A	B	C	D	E	F	Z
Plug							
Colour	black	white	blue	bordeaux	green	brown	waterblue
Part NO.	HSD-04A-S-SD-SG-C4	HSD-04B-S-SD-SG-C4	HSD-04C-S-SD-SG-C4	HSD-04D-S-SD-SG-C4	HSD-04E-S-SD-SG-C4	HSD-04F-S-SD-SG-C4	HSD-04Z-S-SD-SG-C4

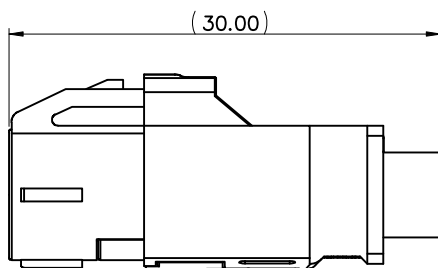
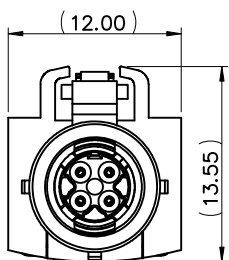
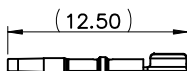

UNLESS OTHERWISE SPECIFIED ALL DIMENSIONS ARE MILLIMETERS TOLERANCES: EXCEPT AS NOTED ANGLE MM X. ± 0.50 .X ± 0.30 .XX ± 0.20		ADAM TECH 909 Rahway Avenue, Union, NJ 07083 Phone: 908-687-5000 Fax: 908-687-5710	
APPROVALS		DATE	
DRAWN	OW	11/20/19	
CHECKED	AC	11/20/19	
APPROVED			
TITLE		HSD FAKRA SOLDER CABLE SOCKET WITH 4P CRIMP HOUSING	
SIZE	PART NO.	REV.	
X	HSD-04X-S-SD-SG-C4	B	
REF:	S00013T	SCALE:	NTS
		SHEET 2 OF 3	

6

5

4

3

2

1

APPROVED: _____

DATE: _____ TITLE: _____

Rev	AWO #	Description	Date	Appr
-----	-------	-------------	------	------

SEE SHT 1 OF 3 FOR REVISION

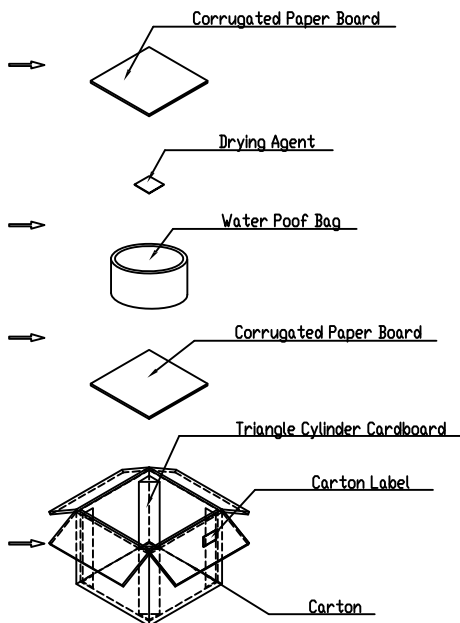
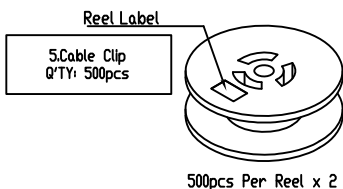
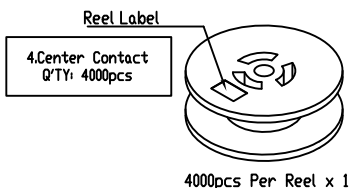
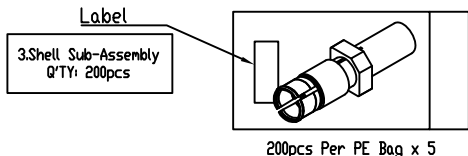
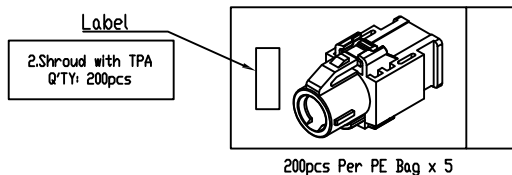
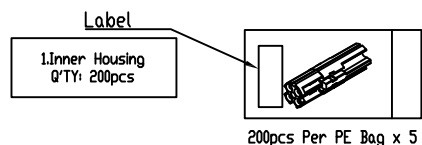

1000 Set Per Outer Carton Box
350x350x300

Fill in a corrugated paper board.
Put 4 triangle cylinder cardboard in all corner.
Put products into water proof bag,
with 4pcs of drying agent.
Make all reel label side up.
Cover with corrugated paper board.
As the indication sticking the label at
the certain place of carton.

NOTES
1. MATERIALS: Box
2. PACKING : 1000 PCS/CARTON
All Material in According With The
RoHs Environment
Related Substances List ControlIde

Items	Qty	Total
1	200pcs/Bag	1000pcs/Carton
2	200pcs/Bag	1000pcs/Carton
3	200pcs/Bag	1000pcs/Carton
4	4000pcs/Reel	4000pcs/Carton
5	500pcs/Reel	1000pcs/Carton
Detailed Items		
Items	Dimension	Amount
Carton	350x350x300mm	1 pcs
Corrugated paper board	330x330mm	2 pcs
Triangle cylinder cardboard		4 pcs/Carton
Water proof bag	600x600mm	1 pcs
Drying agent	2g	4 pcs/Carton
Paper tray	∅ 350mm	3 pcs
Styrofoam	HxD (20x200)mm	4 pcs

UNLESS OTHERWISE SPECIFIED
ALL DIMENSIONS ARE MILLIMETERS
TOLERANCES: EXCEPT AS NOTED
ANGLE

MM
X. ± 0.50
.X ± 0.30
.XX ± 0.20

±5°

**ADAM
TECH**

909 Rahway Avenue,
Union, NJ 07083
Phone: 908-687-5000
Fax: 908-687-5710

APPROVALS		DATE
DRAWN	OW	11/20/19
CHECKED	AC	11/20/19
APPROVED		

TITLE HSD FAKRA SOLDER CABLE SOCKET WITH 4P CRIMP HOUSING		
SIZE X	PART NO. HSD-04X-S-SD-SG-C4	REV. B
REF: S00013T	SCALE: NTS	SHEET 3 OF 3