

LTM4681
**Quad 30A(-A) or Single 120A(-B) μ Module Regulator
with Digital Power System Management**
DESCRIPTION

Demonstration circuit 2924A-A/2924A-B features the [LTM[®]4681](#): the wide input and output voltage range, high efficiency and power density, quad output PolyPhase[®] DC/DC step-down μ Module[®] regulator with digital power system management. Demo board DC2924A is available in two versions: DC2924A-A is configured as 4-phase 4 outputs, DC2924A-B is configured as 4-phase single output. The demo board default input voltage range is 4.5V to 16V. However, if V_{IN} is lower than 6V and within $4.5V \leq V_{IN} \leq 5.75V$ range, minor modification to certain existing onboard components is required. Please refer to the Operation at Low V_{IN} : $4.5V \leq V_{IN} \leq 5.75V$ paragraph for more details. The factory default output voltage (V_{OUT0} , V_{OUT1} , V_{OUT2} and V_{OUT3}) is 1V at 30A maximum load current per channel (DC2924A-A). The factory default output voltage $V_{OUT} = 1V$ at 120A maximum load current (DC2924A-B). Each channel can deliver up to 30A maximum load current but forced airflow and heat sink might also be used to further optimize the output power when all output rails are on and fully loaded. The demo board output voltages can be adjusted from 0.6V up to 1.8V. Programming the output voltages to any value that is greater than 1.8V, requires derating output current based on thermal derating curves provided in the LTM4681 data sheet. The factory default switching frequency is preset at 350kHz typical. Both versions of DC2924A come with PMBus interface and digital power system management functions. An onboard 12-pin

connector is available for users to connect the dongle DC1613A to the demo board, provides an easy way to communicate and program the part using LTpowerPlay[®] software development tool. LTpowerPlay software and I²C/PMBus/SMBus dongle DC1613A allows users to monitor real time telemetry of input and output voltages, input and output current, switching frequency, internal IC die temperatures, external power component temperatures and fault logs. Programmable parameters include device address, output voltages, control loop compensation, switching frequency, phase interleaving, DCM or CCM mode of operation, digital soft-start, sequencing and time based shutdown, fault responses to input and output overvoltage, output overcurrent, IC die and power component overtemperatures.

The LTM4681 is available in a thermally enhanced, low profile 330-Lead (15mm \times 22mm \times 8.17mm) BGA package. It is recommended to read the LTM4681 data sheet and this demo manual prior to use or making any hardware changes to DC2924A-A/DC2924A-B.

LTpowerPlay[®] software can be downloaded at: [LTpowerPlay](#)

USB to PMBus Controller Dongle DC1613A for use with LTpowerPlay is available at: [DC1613A](#)

[Design files for this circuit board are available.](#)

All registered trademarks and trademarks are the property of their respective owners.

DEMO MANUAL

DC2924A-A/DC2924A-B

BOARD PHOTO

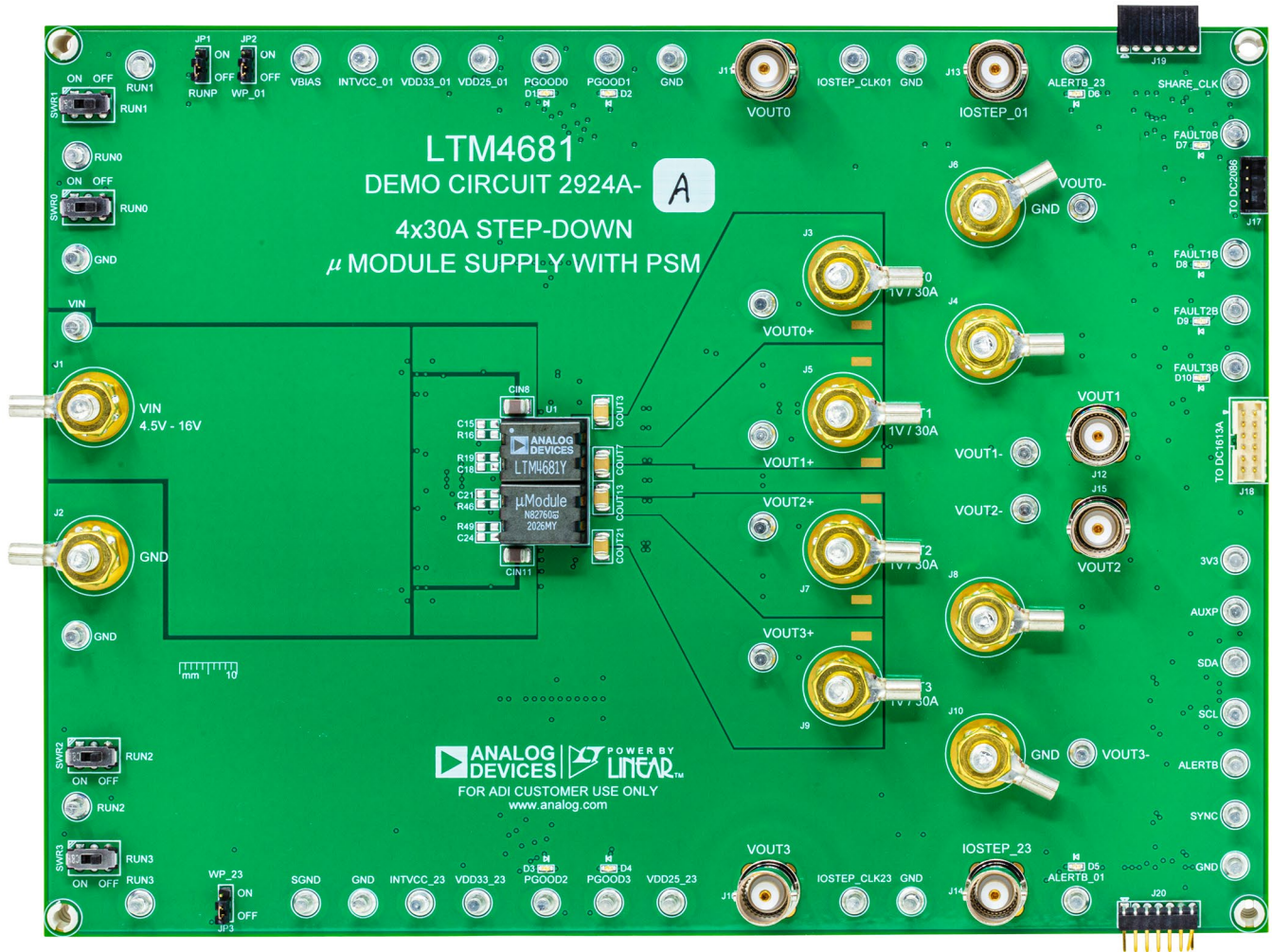

Figure 1. DC2924A-A/DC2924A-B Demo Board

PERFORMANCE SUMMARY Specifications are at $T_A = 25^\circ\text{C}$

DC2924A-A: 4-Phase 4 Outputs

PARAMETER	CONDITIONS	MIN	TYP	MAX	UNIT
Input Voltage V_{IN} Range		7	12	16	V
Demo Board Default Output Voltage V_{OUT0} , V_{OUT1} , V_{OUT2} , V_{OUT3}	$f_{SW} = 350\text{kHz}$, $V_{IN} = 7\text{V to } 16\text{V}$, $I_{OUT} = 0\text{A to } 30\text{A}$ per Channel		1		V
Switching Frequency f_{SW}	Factory Default Switching Frequency		350		kHz
Maximum Continuous Output Current per Channel I_{OUT0} , I_{OUT1} , I_{OUT2} , I_{OUT3}			30	31.25*	A
Efficiency	$f_{SW} = 350\text{kHz}$, $V_{IN} = 12\text{V}$, $V_{OUT0} = 1\text{V}$, $I_{OUT0} = 30\text{A}$, $V_{BIAS} = 5.5\text{V}$ (RUNP: On), Only One Channel Is On at a Time, No Forced Airflow, No Heat Sink		89.6		%

DC2924A-B: 4-Phase Single Output

PARAMETER	CONDITIONS	MIN	TYP	MAX	UNIT
Input Voltage V_{IN} Range		7	12	16	V
Demo Board Default Output Voltage V_{OUT}	$f_{SW} = 350\text{kHz}$, $V_{IN} = 12\text{V}$, $I_{OUT} = 120\text{A}$		1		V
Switching Frequency f_{SW}	Factory Default Switching Frequency		350		kHz
Maximum Continuous Output Current I_{OUT}			120	125*	A
Efficiency	$f_{SW} = 350\text{kHz}$, $V_{IN} = 12\text{V}$, $V_{OUT} = 1\text{V}$, $I_{OUT} = 120\text{A}$, $V_{BIAS} = 5.5\text{V}$ (RUNP: On), No Forced Airflow, No Heat Sink		89.4		%

*Recommended forced airflow: 200LFM to 400 LFM

QUICK START PROCEDURE

Demonstration circuit 2924A-A/2924A-B is easy to set up to evaluate the performance of the LTM4681. Please refer to Figure 2a (DC2924A-A) and Figure 2b (DC2924A-B) for proper measurement equipment setup and follow the test procedures below.

1. With power off, connect the input power supply between V_{IN} (J1) and GND (J2). Set the input voltage supply to 0V.
2. Connect the first load between V_{OUT0} (J3) and GND (J6), connect the second load between V_{OUT1} (J5) and GND (J4), connect the third load between V_{OUT2} (J7) and GND (J8), connect the fourth load between V_{OUT3} (J9) and GND (J10). Preset all the loads to 0A.
3. Connect the DMM between the input test points: V_{IN} (E1) and GND (E2) to monitor the input voltage. Connect DMMs between V_{OUT0}^+ (E3) and V_{OUT0}^- (E4), V_{OUT1}^+ (E5) and V_{OUT1}^- (E6), V_{OUT2}^+ (E7) and V_{OUT2}^- (E8), V_{OUT3}^+ (E9) and V_{OUT3}^- (E10) to monitor the corresponding DC output voltages of channel 0, channel 1, channel 2 and channel 3. These output voltage test points are Kelvin sensed directly across C_{OUT1} (channel 0), C_{OUT8} (channel 1), C_{OUT14} (channel 2), C_{OUT22} (channel 3) to provide accurate measurement of output voltages. Do not apply load current to any of the above test points to avoid damage to the regulator. Do not connect the scope probe ground leads to V_{OUT0}^- , V_{OUT1}^- , V_{OUT2}^- and V_{OUT3}^- .
4. Prior power up the DC2924A-A/DC2924A-B, check the default position of the jumpers and switches (refer to Table1).

Table 1. Demo Board Default Switches and Jumpers Position

SWITCH/ JUMPER NAME	SWR0, SWR1 SWR2, SWR3	JP1	JP2 JP3
DESCRIPTION	RUN0, RUN1 RUN2, RUN3	RUNP	WP_01 WP_23
POSITION	OFF	ON	OFF

5. Turn on the power supply at the input. Slowly increasing the input voltage from 0V to 12V typical. Measure and make sure the input supply voltage is 12V and flip SWR0 (RUN0) and SW1 (RUN1), SWR2 (RUN2) and SWR3 (RUN3) to the ON position. The output

voltages should be $1.0V \pm 0.5\%$ typical for V_{OUT0} , V_{OUT1} , V_{OUT2} and V_{OUT3} .

6. Once the input and output voltages are properly established, adjusting the input voltage between 7V to 16V max and the load current within the operating range of 0A to 30A max per channel. Observe the output voltage regulation, output voltage ripples, switching node waveform, load transient response and other parameters. Refer to Figure 3 for proper output voltage ripples measurement.

NOTE: To measure the input/output voltage ripples properly, do not use the long ground lead on the oscilloscope probe. See Figure 3 for the proper scope probe technique. Short, stiff leads need to be soldered to the (+) and (-) terminals of an input or output capacitor. The probe's ground ring needs to touch the (-) lead and the probe tip needs to touch the (+) lead.

The output voltage ripples of channel 0, channel 1, channel 2 and channel 3 can also be monitored using onboard BNC terminals. Connect short BNC cables from V_{OUT0} (J11), V_{OUT1} (J12), V_{OUT2} (J15) and V_{OUT3} (J16) to the inputs of a 4-channel oscilloscope (scope probe ratio 1:1, AC-coupling) to observe output voltage ripples.

7. (Option) Operation with V_{BIAS}

V_{BIAS} pin is the 5.5V output of an internal buck regulator that can be enabled or disabled with RUNP. V_{BIAS} regulator input is V_{IN_VBIAS} pin and powered from V_{IN} . The advantage of using V_{BIAS} is bypassing the internal $INTVCC_LDO$ powered from V_{IN} , turning on the internal switch connected the 5.5V V_{BIAS} to $INTVCC_01$ and $INTVCC_23$ of the part, therefore reducing the power loss, improving the overall efficiency and lower the temperature rise of the part while operating at high V_{IN} and high switching frequency. V_{BIAS} must exceed 4.8V and V_{IN} must be greater than 7V to activate the internal switch connecting V_{BIAS} to $INTVCC_01$ and $INTVCC_23$ of the part. In typical applications, it is recommended to enable V_{BIAS} .

QUICK START PROCEDURE

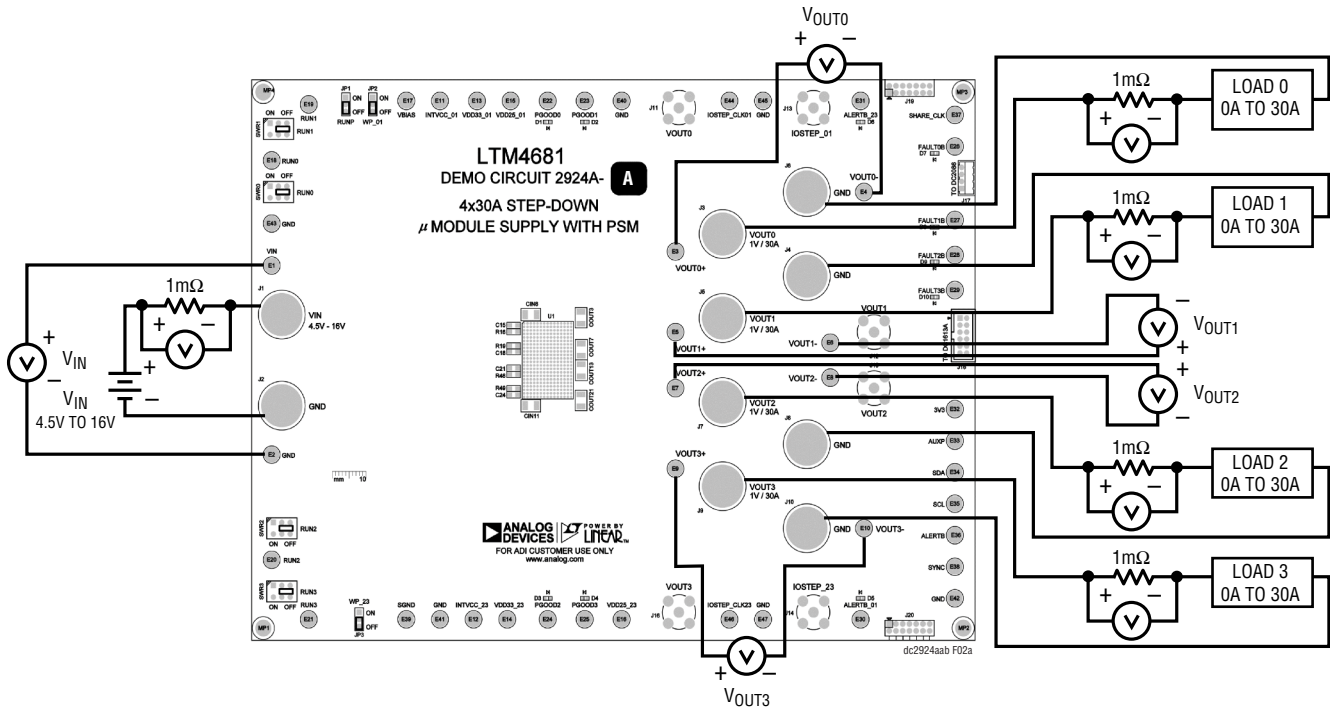

(a) DC2924A-A

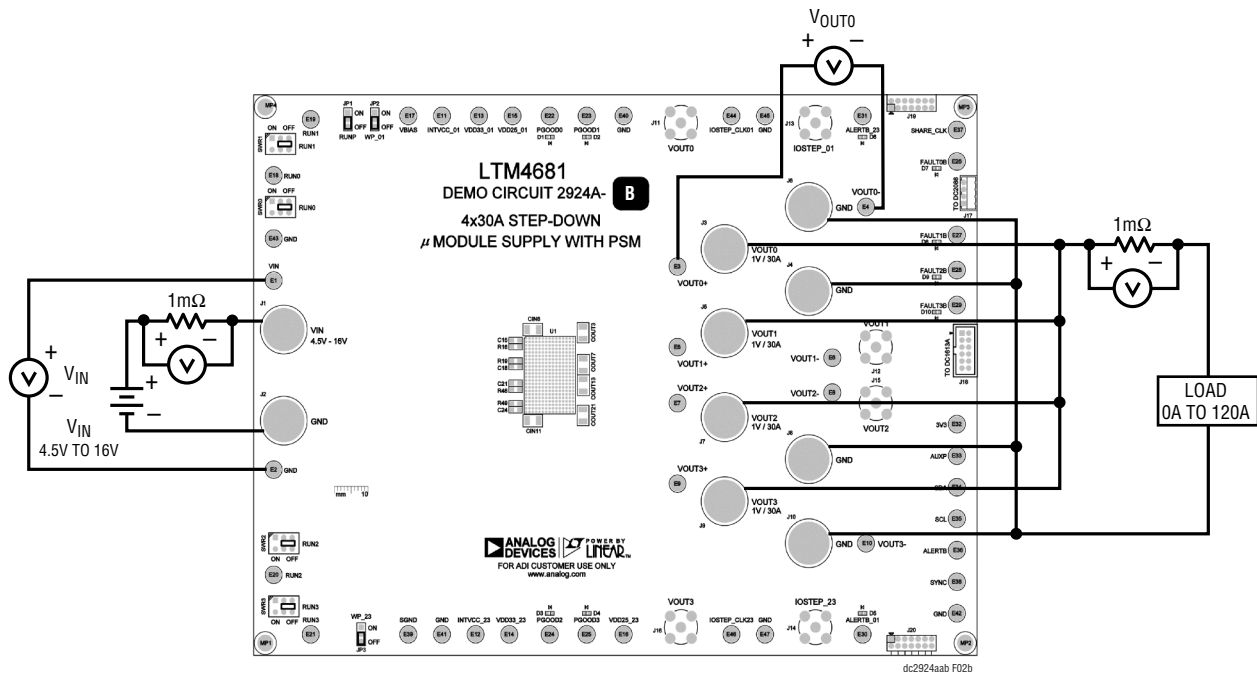

(b) DC2924A-B

Figure 2. Proper Measurement Equipment Setup

QUICK START PROCEDURE

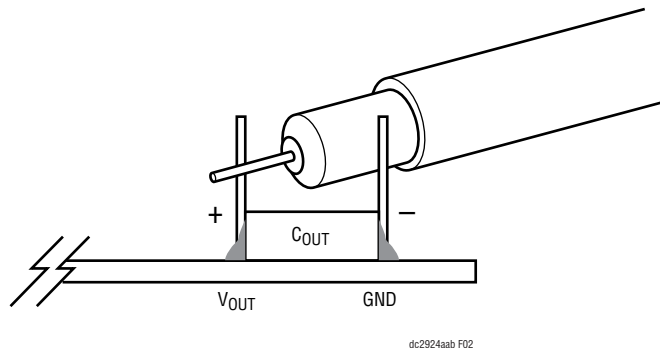

Figure 3. Scope Probe Placement for Measuring Output Ripple Voltage

8. *Operation at Low V_{IN} : $4.5V \leq V_{IN} \leq 5.75V$*

Set RUNP (JP1) to the “OFF” position. Remove R1 to disconnect VIN_VBIAS from V_{IN} . Remove the existing onboard C1 ceramic capacitor and stuff a zero-ohm resistor at C1 to short VIN_VBIAS to GND.

Tie SVIN_01 to INTVCC_01 by stuffing R105 with a zero-ohm resistor. Tie SVIN_23 to INTVCC_23 by stuffing R106 with a zero-ohm resistor. Make sure V_{IN} is within $4.5V \leq V_{IN} \leq 5.75V$. Additional input electrolytic capacitors may be installed between V_{IN} (J1) and GND (J2) to prevent V_{IN} from drooping or overshoot to a voltage level that can exceed the specified minimum V_{IN} (4.5V) and maximum V_{IN} (5.75V) during large output load transient.

9. *(Option) Onboard Load Step Circuit*

DC2924A-A/DC2924A-B provides onboard load transient circuit to measure ΔV_{OUT} peak-to-peak deviation during rising or falling dynamic load transient. The simple load step circuit consisting of two paralleled 40V N-channel power MOSFETs in series with two paralleled 10m Ω , 1W, 1% current sense resistors. The MOSFETs are configured as voltage control current source (V_{CCS}) devices; therefore, the output current step and its magnitude is created and controlled by adjusting the amplitude of the applied input voltage step at the gate of the MOSFETs. Use a function generator to provide a voltage pulse between IOSTEP_CLK01 (E44) and GND (E45). The input voltage pulse should be set at pulse width less than 300 μ s and maximum duty cycle less than 2% to avoid excessive thermal stress on the MOSFET devices. The output

current step is measured directly across the current sense resistors and monitored by connecting BNC cable from IOSTEP_01 (J13) to the input of the oscilloscope (scope probe ratio 1:1, DC-coupling). The equivalent voltage to current scale is 5mV/1A. The load step current slew rate d_i/d_t can be varied by adjusting the rise time and fall time of the input voltage pulse. The load-step circuit of channel 0 or channel 1 is connected to V_{OUT0} by default but can be used for V_{OUT1} by simply removing the zero-ohm jumper R128 and stuffing it at the position of R129 and vice versa. Only one resistor: R128 or R129 can be stuffed at a time to avoid shorting V_{OUT0} and V_{OUT1} together. Repeat step 9 to perform load step transient evaluation for V_{OUT1} rail. Similarly, load step transient evaluation of V_{OUT2} or V_{OUT3} can be performed using the same method described above. Refer to the demo board DC2924A-A schematic, for more details. Output ripple voltage and output voltage during load transient of DC2924A-B should be measured across C_{OUT29} using probe jack and 1 \times scope probe. DC output voltage of DC2924A-B should be measured between V_{OUT0}^+ and V_{OUT0}^- .

10. *Connecting a PC to DC2924A-A/DC2924A-B*

Refer to Figure 4a (DC2924A-A) and Figure 4b (DC2924A-B) for proper demo board setup with PC. Users can use a PC to reconfigure the power management features of the LTM4681 such as: nominal V_{OUT} , margin set points, OV/UV limits, output current and temperature fault limits, sequencing parameters, the fault logs, fault responses, GPIOs and other functionality. The DC1613A dongle can be hot plugged when V_{IN} is present.

QUICK START PROCEDURE

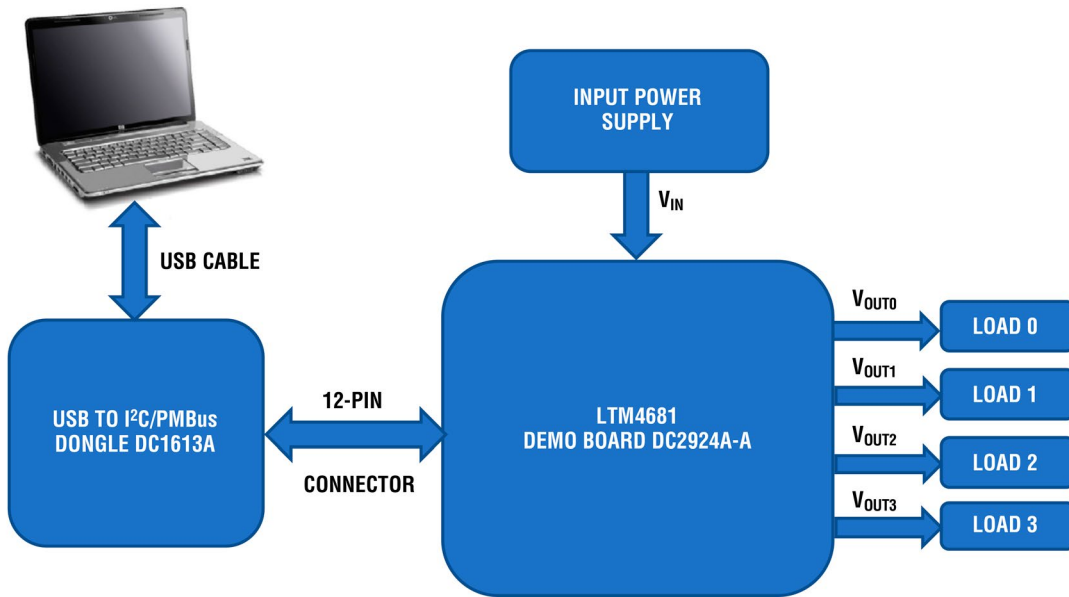

(a) DC2924A-A

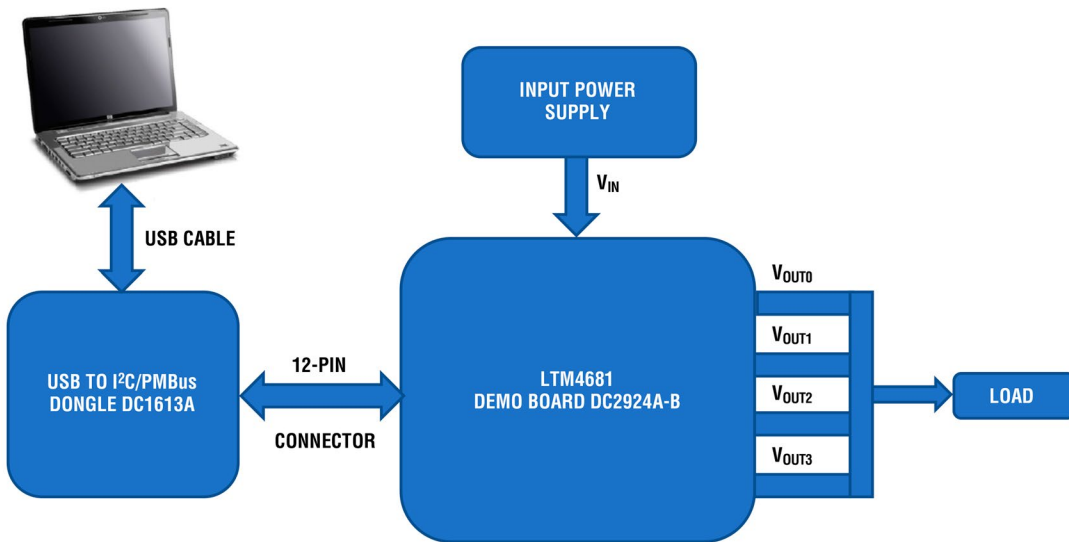

(b) DC2924A-B

Figure 4. Demo Board Setup with PC

DEMO MANUAL

DC2924A-A/DC2924A-B

LTpowerPlay QUICK START GUIDE

LTpowerPlay is a powerful Windows-based development environment that supports ADI power system management ICs. The software supports a variety of different tasks. You can use LTpowerPlay to evaluate ADI PSM μ Module by connecting to a demo board system. LTpowerPlay can also be used in an off-line mode (with no hardware present) to build a multichip configuration file that can be saved and reloaded anytime. LTpowerPlay provides unprecedented diagnostic tool and debug features. It becomes a valuable diagnostic tool during board bring-up to program or tweak the power management scheme in a system, or to diagnose power issues when bringing up rails. LTpowerPlay utilizes the DC1613A USB-to-PMBus controller to communicate with one of many

potential targets, including all the parts in PSM product category demo system. The software also provides an automatic update feature to keep the software current with the latest set of device drivers and documentation. The LTpowerPlay software can be downloaded from: [LTpowerPlay](#).

USB to PMBus Controller Dongle DC1613A for use with LTpowerPlay is available at [DC1613A](#).

To access technical support documents for ADI Digital Management Products, visit Help or view on-line help on the LTpowerPlay menu. The following procedure describes how to use LTpowerPlay to monitor and change the settings of LTM4681.

1. Download and install the [LTpowerPlay GUI](#)

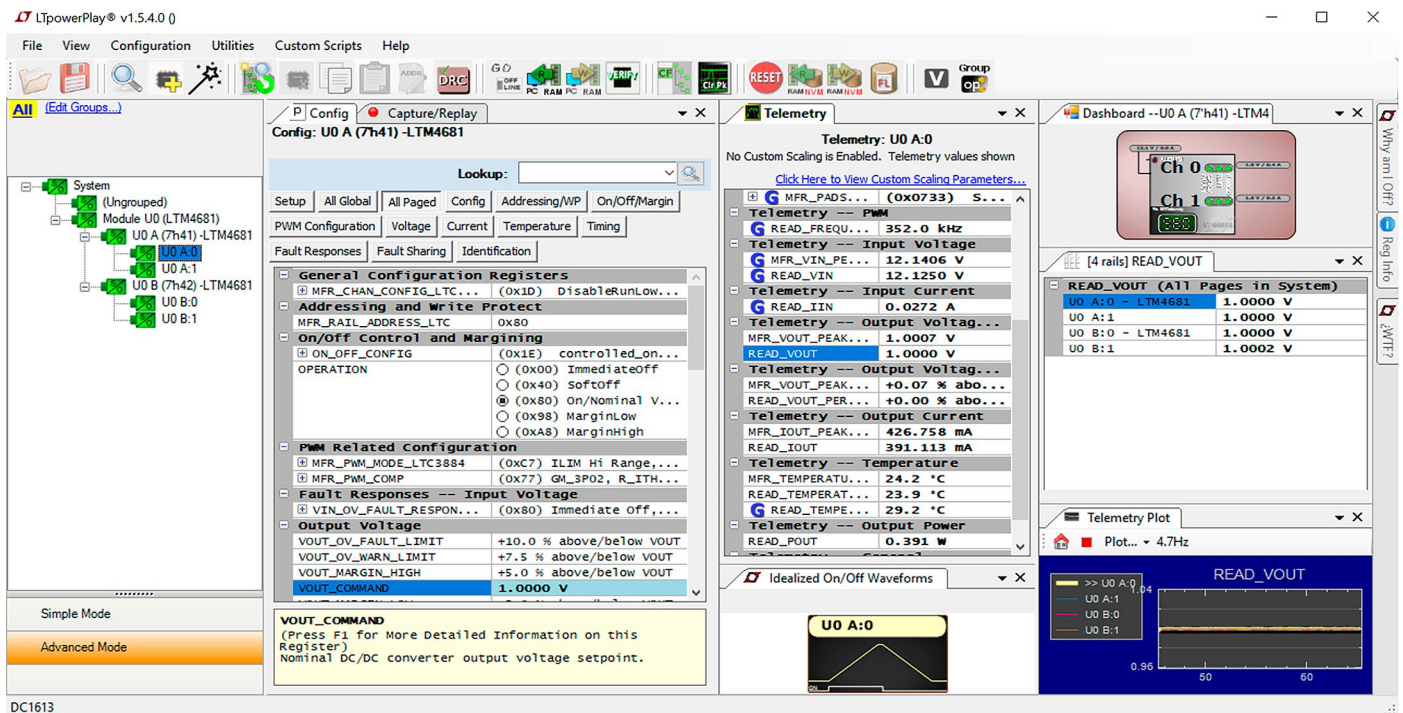
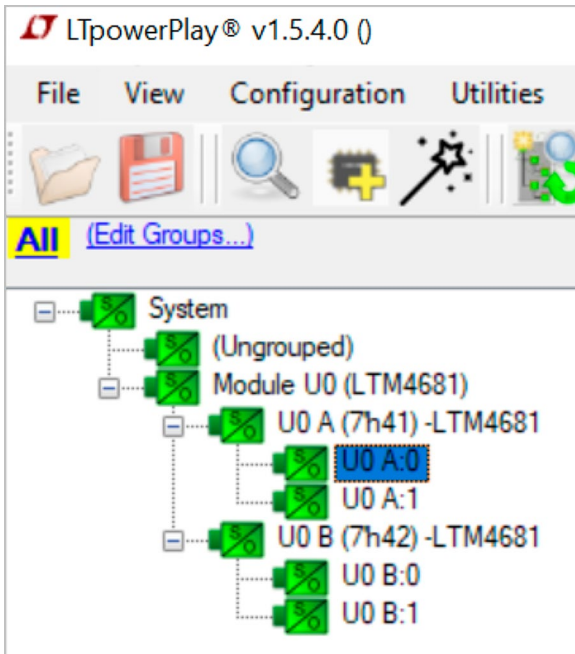

Figure 5. LTpowerPlay Main Interface

LTpowerPlay QUICK START GUIDE

2. Launch the LTpowerPlay GUI
 - a. The GUI should automatically identify the DC2924A-A or DC2924A-B

The system tree on the left-hand side should look like this for DC2924A-A:



Or the system tree on the left-hand side should look like this for DC2924A-B:

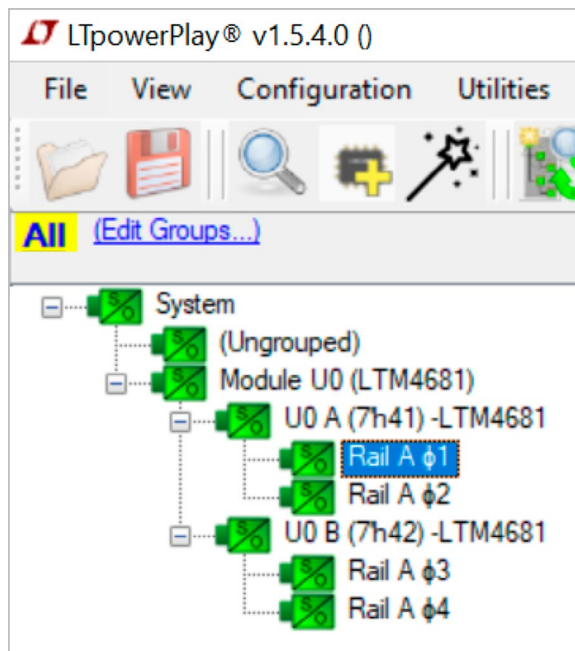

- b. A green message box shows for a few seconds in the lower left-hand corner, confirming that LTM4681 is communicating:

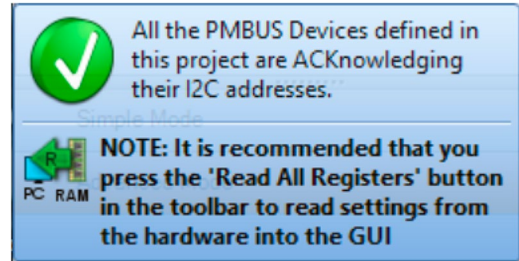

- c. In the Toolbar, click the “R” (RAM to PC) icon to read the RAM from the LTM4681. The configuration is read from the LTM4681 and loaded into the GUI:



- d. Example of program the output voltage to a different value. In the Config Tab, click on the “Voltage” Tab in the main menu bar, type in 1.2V in the VOUT_COMMAND box as showed below:

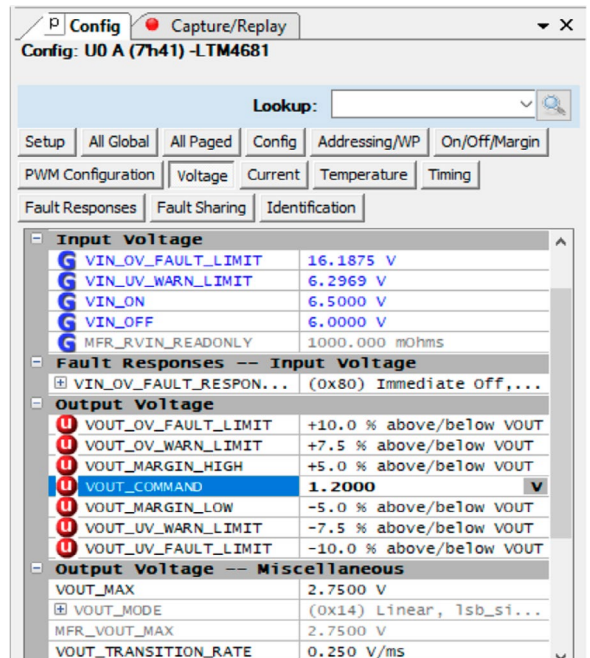

LTpowerPlay QUICK START GUIDE

Then click the “W” (PC to RAM) icon to write these register values to the LTM4681.



The output voltage will change to 1.2V. If the write command is successfully executed, the following message should be seen:

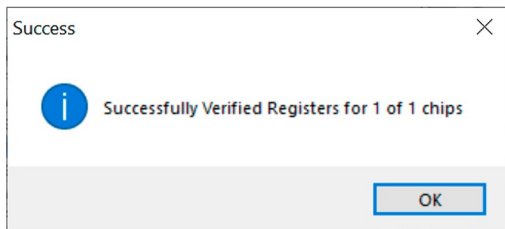

e. All user configuration or changes can be saved into the NVM. In the toolbar, click “RAM to NVM” icon:



f. Save the demo board configuration to a (*.proj) file. Click the Save icon and save the file with a preferred file name.

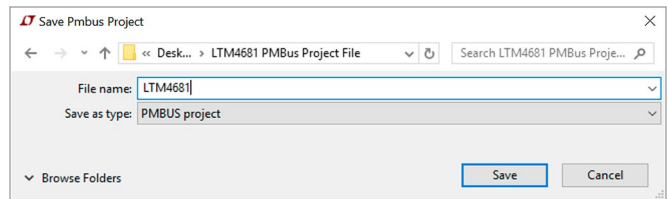

TYPICAL PERFORMANCE CHARACTERISTICS

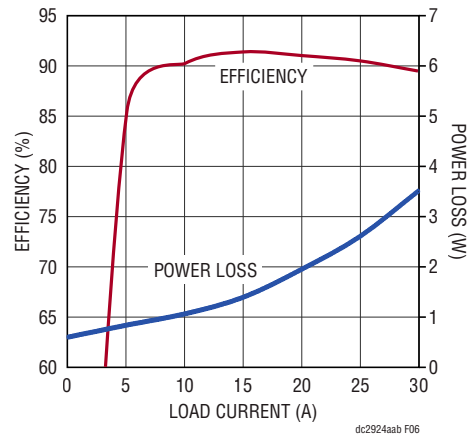

CIRCUIT CONFIGURATION: 4-PHASE 4 OUTPUTS
 $f_{SW} = 350\text{kHz}$
 $V_{OUT} = 1\text{V}$
 $I_{LOAD} = 0\text{A TO } 30\text{A}$
 $V_{BIAS} = 5.5\text{V (RUNP: ON)}$
 V_{IN}, V_{OUT} WAS MEASURED ACROSS C_{IN8}, C_{OUT3}
 ONE RAIL IS ENABLED AT A TIME

Figure 6. DC2924A-A: Efficiency, $T_a=25^\circ\text{C}$, No Forced Airflow, No Heat Sink

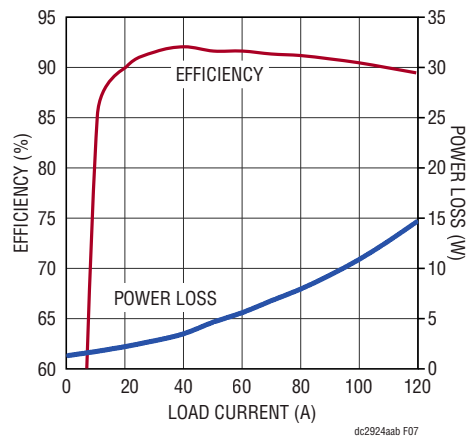

CIRCUIT CONFIGURATION: 4-PHASE SINGLE OUTPUT
 $f_{SW} = 350\text{kHz}$
 $V_{OUT} = 1\text{V}$
 $I_{LOAD} = 0\text{A TO } 120\text{A}$
 $V_{BIAS} = 5.5\text{V (RUNP: ON)}$
 V_{IN}, V_{OUT} WAS MEASURED ACROSS C_{IN8}, C_{OUT3}

Figure 7. DC2924A-B: Efficiency, $T_a=25^\circ\text{C}$, No Forced Airflow, No Heat Sink

TYPICAL PERFORMANCE CHARACTERISTICS

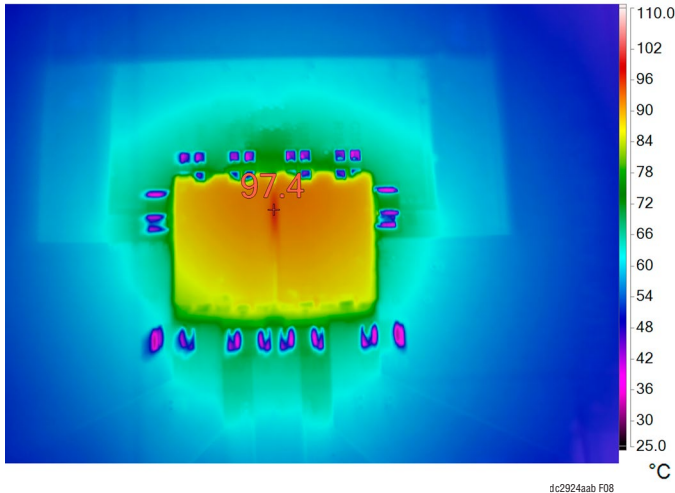

CIRCUIT CONFIGURATION: 4-PHASE 4 OUTPUTS
 $f_{sw} = 350\text{kHz}$
 $V_{OUT0}, V_{OUT1}, V_{OUT2}, V_{OUT3} = 1\text{V}$
 $I_{LOAD0}, I_{LOAD1}, I_{LOAD2}, I_{LOAD3} = 30\text{A PER CHANNEL}$
 $V_{BIAS} = 5.5\text{V (RUNP: ON)}$

Figure 8. DC2924A-A: Thermal Performance, $T_A = 25^\circ\text{C}$, No Forced Airflow, No Heat Sink

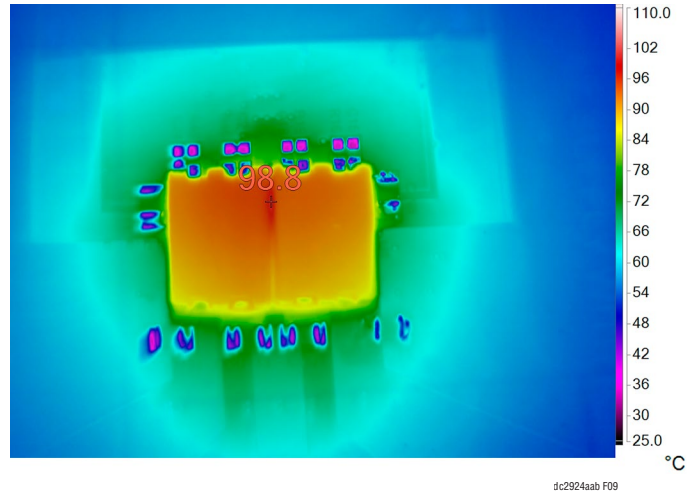

CIRCUIT CONFIGURATION: 4-PHASE SINGLE OUTPUT
 $f_{sw} = 350\text{kHz}$
 $V_{OUT0} = 1\text{V}$
 $I_{LOAD} = 120\text{A}$
 $V_{BIAS} = 5.5\text{V (RUNP: ON)}$

Figure 9. DC2924A-B: Thermal Performance, $T_A = 25^\circ\text{C}$, No Forced Airflow, No Heat Sink

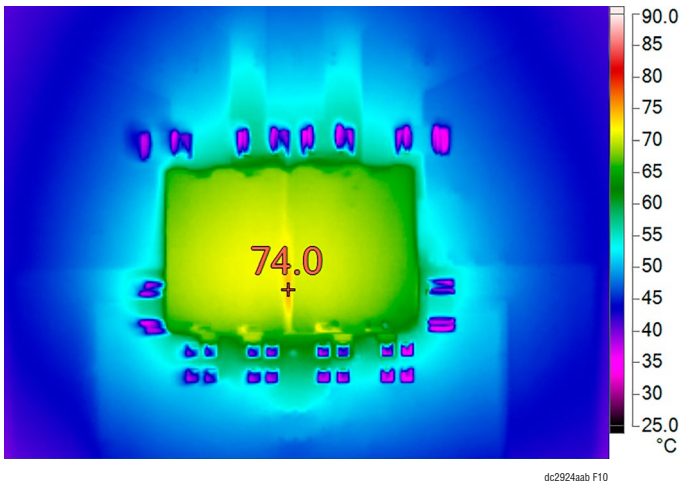

CIRCUIT CONFIGURATION: 4-PHASE 4 OUTPUTS
 $f_{sw} = 350\text{kHz}$
 $V_{OUT0}, V_{OUT1}, V_{OUT2}, V_{OUT3} = 1\text{V}$
 $I_{LOAD0}, I_{LOAD1}, I_{LOAD2}, I_{LOAD3} = 30\text{A PER CHANNEL}$
 $V_{BIAS} = 5.5\text{V (RUNP: ON)}$

Figure 10. DC2924A-A: Thermal Performance with Airflow, $T_A = 25^\circ\text{C}$, Forced Airflow = 250LFM, No Heat Sink

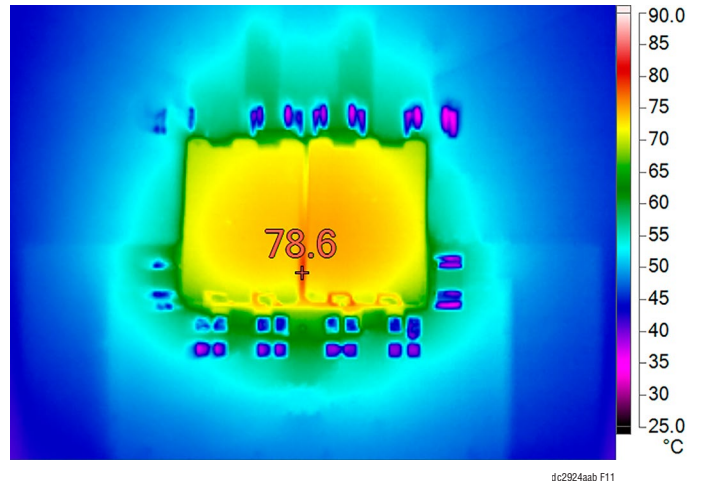

CIRCUIT CONFIGURATION: 4-PHASE SINGLE OUTPUT
 $f_{sw} = 350\text{kHz}$
 $V_{OUT} = 1\text{V}$
 $I_{LOAD} = 120\text{A}$
 $V_{BIAS} = 5.5\text{V (RUNP: ON)}$

Figure 11. DC2924A-B: Thermal Performance with Airflow, $T_A = 25^\circ\text{C}$, Forced Airflow = 250LFM, No Heat Sink

TYPICAL PERFORMANCE CHARACTERISTICS

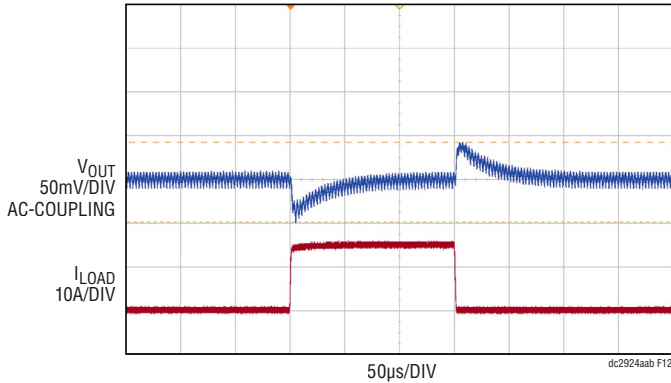

CIRCUIT CONFIGURATION: 4-PHASE 4 OUTPUTS
 $f_{SW} = 350\text{kHz}$
 $V_{OUT} = 1\text{V}$
 $I_{LOAD-STEP} = 0\text{A TO } 15\text{A AT } diL/dt = 15\text{A}/\mu\text{s}$
 $V_{OUT(P-P)} = 91\text{mV}$
 OUTPUT VOLTAGE WAS MEASURED AT V_{OUT0} BNC

Figure 12. DC2924A-A: Load Transient Response

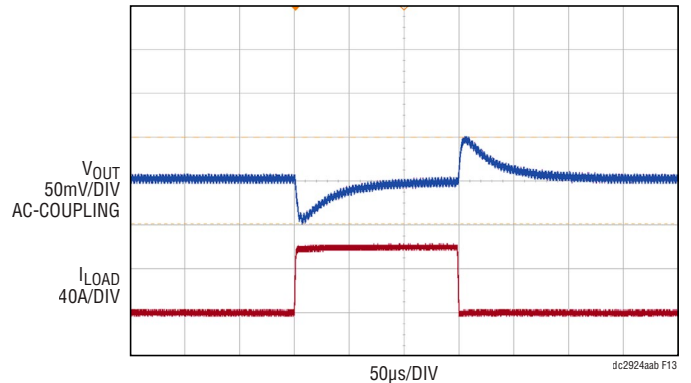

CIRCUIT CONFIGURATION: 4-PHASE SINGLE OUTPUT
 $f_{SW} = 350\text{kHz}$
 $V_{OUT} = 1\text{V}$
 $I_{LOAD-STEP} = 0\text{A TO } 60\text{A AT } diL/dt = 60\text{A}/\mu\text{s}$
 $V_{OUT(P-P)} = 98\text{mV}$
 OUTPUT VOLTAGE WAS MEASURED ACROSS C_{OUT29}

Figure 13. DC2924A-B: Load Transient Response

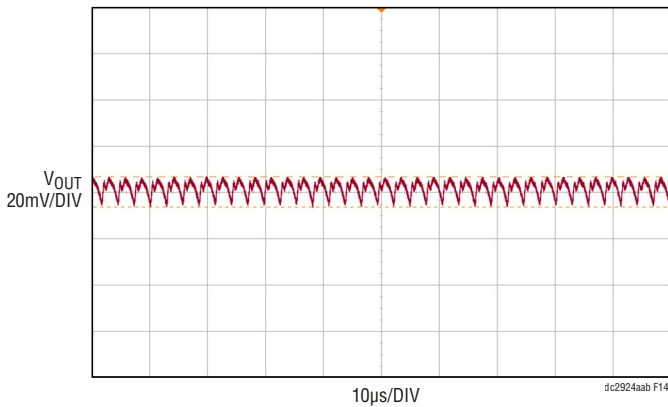

CIRCUIT CONFIGURATION: 4-PHASE 4 OUTPUTS
 $f_{SW} = 350\text{kHz}$
 $V_{OUT} = 1\text{V}$
 $I_{LOAD} = 30\text{A}$
 $V_{OUT(P-P)} = 13.1\text{mV}$
 OUTPUT RIPPLE VOLTAGE WAS MEASURED AT V_{OUT0} BNC
 AC-COUPLING, 20MHz BWL

Figure 14. DC2924A-A: Output Ripple Voltage

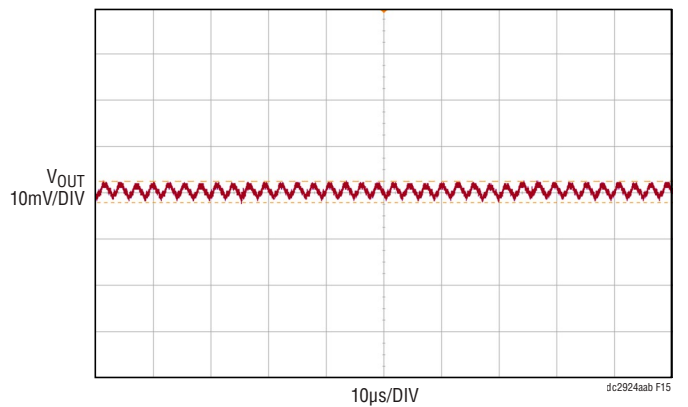

CIRCUIT CONFIGURATION: 4-PHASE SINGLE OUTPUT
 $f_{SW} = 350\text{kHz}$
 $V_{OUT} = 1\text{V}$
 $I_{LOAD} = 120\text{A}$
 $V_{OUT(P-P)} = 4.7\text{mV}$
 OUTPUT RIPPLE VOLTAGE WAS MEASURED ACROSS C_{OUT29}
 1x SCOPE PROBE AND PROBE JACK USED
 AC-COUPLING, 20MHz BWL

Figure 15. DC2924A-B: Output Ripple Voltage

DEMO MANUAL

DC2924A-A/DC2924A-B

PARTS LIST DC2924A-A

ITEM	QTY	REFERENCE	PART DESCRIPTION	MANUFACTURER/PART NUMBER
DC2924A-A Required Circuit Components				
1	5	C1, C7, C8, C10, C11	CAP, 1 μ F, X7R, 25V,10%, 0603, AEC-Q200	MURATA, GCM188R71E105KA64D
2	2	C2, C3	CAP, 2.2 μ F, X5R, 25V, 10%, 0603	MURATA, GRM188R61E225KA12D
3	2	C6, C9	CAP, 4.7 μ F, X5R, 16V, 10%, 0603	MURATA, GRM188R61C475KAAJD
4	1	C12	CAP, 22 μ F, X5R, 16V, 10%, 1206	AVX, 1206YD226KAT2A
5	4	C13, C16, C19, C22	CAP, 2200pF, X7R, 50V, 5%, 0603	AVX, 06035C222JAT2A
6	4	C14, C17, C20, C23	CAP, 150pF, C0G/NP0, 50V,5%, 0603	AVX, 06035A151JAT2A
7	4	C25-C28	CAP, 0.01 μ F, X7R, 50V,10%, 0603	AVX, 06035C103KAT2A
8	13	C29, C30, C44, C46, C47, C53, C54, C56, C57, C59, C60, C62, C63	CAP, 0.1 μ F, X7R, 16V,10%, 0603, FLEXITERM	AVX, 0603YC104KAZ2A
9	2	C45, C48	CAP, 100 μ F, X5R, 6.3V, 10%, 1206	MURATA, GRM31CR60J107KE39L
10	20	C49-C52, COUT1-COUT4, COUT7-COUT10, COUT13-COUT16, COUT21-COUT24	CAP, 100 μ F, X5R, 6.3V, 20%, 1210	AVX, 12106D107MAT2A
11	4	C55, C58, C61, C64	CAP, 0.1 μ F, X7R, 16V, 10%, 0805	KEMET, C0805C104K4RACTU
12	4	CIN1-CIN4	CAP, 180 μ F, ALUM POLY, OS-CON, 25V, 20%, 8mm x 11.9mm, SMD, RADIAL, E12	PANASONIC, 25SVPF180M
13	10	CIN5-CIN14	CAP, 22 μ F, X5R, 25V, 10%, 1210	KEMET, C1210C226K3PACTU
14	12	COUT5, COUT6, COUT11, COUT12, COUT17-COUT20, COUT25-COUT28	CAP, 470 μ F, TANT, POSCAP, 2.5V, 20%, 7343, TPF SERIES	PANASONIC, ETPF470M5H
15	4	D1-D4	LED, GREEN, WATER CLEAR, 0603	WURTH ELEKTRONIK, 150060GS75000
16	6	D5-D10	LED, RED, WATER CLEAR, 0603	WURTH ELEKTRONIK, 150060RS75000
17	2	D11, D12	DIODE, SCHOTTKY, 20V, 0.5A, SOD-882, LEADLESS	NEXPERIA, PMEG2005AEL.315
18	10	J1-J10	EVAL BOARD STUD HARDWARE SET, #10-32	ANALOG DEVICES, 720-0010
19	4	Q3-Q6	XSTR., MOSFET, N-CH, 60V, 220mA, SOT23-3, AEC-Q101	DIODES INC., 2N7002A-13
20	6	Q7-Q12	XSTR., MOSFET, P-CH, 20V, 5.9A, SOT-23-3 (TO-236-3)	VISHAY, Si2365EDS-T1-GE3
21	4	Q13-Q16	XSTR., MOSFET, N-CH, 40V, 14A, DPAK (TO-252)	VISHAY, SUD50N04-8M8P-4GE3
22	3	R1-R3	RES., 1 Ω , 1%, 1/10W, 0603, AEC-Q200	NIC, NRC06F1R00TRF
23	2	R4, R8	RES., 0.002 Ω , 1%, 1W,2512, SENSE	VISHAY, WSL25122L000FEA
24	18	R6, R7, R10, R11, R13, R143-R153, R156, R160	RES., 0 Ω , 1/10W, 0603, AEC-Q200	VISHAY, CRCW06030000Z0EA
25	12	R14, R15, R17, R18, R44, R45, R47, R48, R136, R138, R140, R142	RES., 10 Ω , 1%, 1/10W, 0603	VISHAY, CRCW060310R0FKEA
26	18	R20, R21, R26-R29, R50-R55, R125, R130, R135, R137, R139, R141	RES., 10k, 1%, 1/10W, 0603, AEC-Q200	VISHAY, CRCW060310K0FKEA
27	8	R22-R25, R56-R59	RES., 4.99k, 1%, 1/10W, 0603, AEC-Q200	PANASONIC, ERJ3EKF4991V
28	1	R33	RES., 787 Ω , 1%, 1/10W, 0603	NIC, NRC06F7870TRF
29	1	R61	RES., 1.65k, 1%, 1/10W, 0603	NIC, NRC06F1651TRF
30	10	R115-R124	RES., 301 Ω , 1%, 1/10W, 0603, AEC-Q200	PANASONIC, ERJ3EKF3010V
31	4	R126, R127, R131, R132	RES., 0.01 Ω , 1%, 1W, 2512, METAL, SENSE	PANASONIC, ERJM1WSF10MU
32	2	R128, R133	RES., 0 Ω , 1W, 2512, SENSE, COPPER	VISHAY, WSL251200000ZEA9
33	2	R168, R169	RES., 4.99k, 1%, 1/10W, 0603	PANASONIC, ERJ3EKF4991V
34	4	SWR0-SWR3	SWITCH, SLIDE, DPDT, 0.3A, 6VDC, PTH	C&K, JS202011CQN

PARTS LIST DC2924A-A

ITEM	QTY	REFERENCE	PART DESCRIPTION	MANUFACTURER/PART NUMBER
35	1	U1	IC, QUAD OUTPUT μ Module REG., BGA	ANALOG DEVICES, LTM4681EY#PBF
36	1	U2	IC, MEMORY, EEPROM, 2KBIT (256x8), TSSOP-8, 400kHz	MICROCHIP, 24LC025-I/ST

DC2924A-A Additional Demo Board Circuit Components

1	0	C4, C5	CAP, OPTION, 0603	
2	0	C15, C18, C21, C24	CAP, OPTION, 0805	
3	0	COUT29	CAP, OPTION, 1210	
4	0	D13-D16	DIODE, OPTION, SOD-323	
5	0	Q1, Q2	XSTR., OPTION, MOSFET, P-CH, SOT-23	
6	0	R5, R9, R72-R83, R111-R114, R129, R134	RES., OPTION, 2512	
7	0	R12, R32, R34-R43, R60, R62-R71, R84-R110, R154, R155, R157-R159, R161-R167, R170-R178	RES., OPTION, 0603	
8	0	R16, R19, R46, R49	RES., OPTION, 0805	

DC2924A-A Hardware: For Demo Board Only

1	47	E1-E47	TEST POINT, TURRET, 0.094" MTG. HOLE, PCB 0.062" THK	MILL-MAX, 2501-2-00-80-00-00-07-0
2	6	J11-J16	CONN., REBNC, RCPT, JACK, 5-PIN, ST, THT, 50 Ω	AMPHENOL RF, 112404
3	1	J17	CONN., HDR, SHROUDED, MALE, 1x4,2mm, VERT, ST, THT	HIROSE ELECTRIC, DF3A-4P-2DSA
4	1	J18	CONN., HDR, SHROUDED, MALE, 2x6, 2mm, VERT, ST, THT	AMPHENOL, 98414-G06-12ULF
5	1	J19	CONN., HDR, FEMALE, 2x7, 2mm, R/A THT	SULLINS CONNECTOR SOLUTIONS, NPPN072FJFN-RC
6	1	J20	CONN., HDR, MALE, 2x7, 2mm, R/A THT	MOLEX, 0877601416
7	3	JP1-JP3	CONN., HDR, MALE, 1x3, 2mm, VERT, ST, THT, NO SUBS. ALLOWED	WURTH ELEKTRONIK, 62000311121
8	4	MP1-MP4	STANDOFF, NYLON, SNAP-ON, 0.50"	KEYSTONE, 8833
9	3	XJP1-XJP3	CONN., SHUNT, FEMALE, 2 POS, 2mm	WURTH ELEKTRONIK, 60800213421

DEMO MANUAL

DC2924A-A/DC2924A-B

PARTS LIST DC2924A-B

ITEM	QTY	REFERENCE	PART DESCRIPTION	MANUFACTURER/PART NUMBER
DC2924A-B Required Circuit Components				
1	5	C1, C7, C8, C10, C11	CAP, 1 μ F, X7R, 25V, 10%, 0603, AEC-Q200	MURATA, GCM188R71E105KA64D
2	2	C2, C3	CAP, 2.2 μ F, X5R, 25V, 10%, 0603	MURATA, GRM188R61E225KA12D
3	2	C6, C9	CAP, 4.7 μ F, X5R, 16V, 10%, 0603	MURATA, GRM188R61C475KAAJD
4	1	C12	CAP, 22 μ F, X5R, 16V, 10%, 1206	AVX, 1206YD226KAT2A
5	1	C13	CAP, 8200pF, X7R, 16V, 5%, 0603	AVX, 0603YC822JAT2A
6	1	C14	CAP, 220pF, X7R, 50V, 5%, 0603	KEMET, C0603C221J5RAC7867
7	3	C17, C20, C23	CAP, 10pF, C0G, 50V, 5%, 0603	AVX, 06035A100JAT2A
8	1	C25	CAP, 0.01 μ F, X7R, 50V, 10%, 0603	AVX, 06035C103KAT2A
9	13	C29, C30, C44, C46, C47, C53, C54, C56, C57, C59, C60, C62, C63	CAP, 0.1 μ F, X7R, 16V, 10%, 0603, FLEXITERM	AVX, 0603YC104KAZ2A
10	2	C45, C48	CAP, 100 μ F, X5R, 6.3V, 10%, 1206	MURATA, GRM31CR60J107KE39L
11	21	C49-C52, COUT1-COUT4, COUT7-COUT10, COUT13-COUT16, COUT21-COUT24, COUT29	CAP, 100 μ F, X5R, 6.3V, 20%, 1210	AVX, 12106D107MAT2A
12	4	C55, C58, C61, C64	CAP, 0.1 μ F, X7R, 16V, 10%, 0805	KEMET, C0805C104K4RACTU
13	4	CIN1-CIN4	CAP, 180 μ F, ALUM POLY, OS-CON, 25V, 20%, 8mm x 11.9mm, SMD, RADIAL, E12	PANASONIC, 25SVPF180M
14	10	CIN5-CIN14	CAP, 22 μ F, X5R, 25V, 10%, 1210	KEMET, C1210C226K3PACTU
15	12	COUT5, COUT6, COUT11, COUT12, COUT17-COUT20, COUT25-COUT28	CAP, 470 μ F, TANT, POSCAP, 2.5V, 20%, 7343, TPF SERIES	PANASONIC, ETPF470M5H
16	4	D1-D4	LED, GREEN, WATER CLEAR, 0603	WURTH ELEKTRONIK, 150060GS75000
17	6	D5-D10	LED, RED, WATER CLEAR, 0603	WURTH ELEKTRONIK, 150060RS75000
18	2	D11, D12	DIODE, SCHOTTKY, 20V, 0.5A, SOD-882, LEADLESS	NEXPERIA, PMEG2005AEL, 315
19	10	J1-J10	EVAL BOARD STUD HARDWARE SET, #10-32	ANALOG DEVICES, 720-0010
20	4	Q3-Q6	XSTR., MOSFET, N-CH, 60V, 220mA, SOT23-3, AEC-Q101	DIODES INC., 2N7002A-13
21	6	Q7-Q12	XSTR., MOSFET, P-CH, 20V, 5.9A, SOT-23-3 (TO-236-3)	VISHAY, Si2365EDS-T1-GE3
22	4	Q13-Q16	XSTR., MOSFET, N-CH, 40V, 14A, DPAK (TO-252)	VISHAY, SUD50N04-8M8P-4GE3
23	3	R1-R3	RES., 1 Ω , 1%, 1/10W, 0603, AEC-Q200	NIC, NRC06F1R00TRF
24	2	R4, R8	RES., 0.002 Ω , 1%, 1W, 2512, SENSE	VISHAY, WSL25122L000FEA
25	39	R6, R7, R10, R11, R13, R84-R104, R143-R153, R156, R160	RES., 0 Ω , 1/10W, 0603, AEC-Q200	VISHAY, CRCW06030000Z0EA
26	15	R20, R21, R26-R29, R50-R55, R125, R130, R135	RES., 10k, 1%, 1/10W, 0603, AEC-Q200	VISHAY, CRCW060310K0FKEA
27	6	R22-R24, R57-R59	RES., 1k, 1%, 1/10W, 0603	VISHAY, CRCW06031K00FKEA
28	4	R25, R56, R168, R169	RES., 4.99k, 1%, 1/10W, 0603	PANASONIC, ERJ3EKF4991V
29	1	R33	RES., 787 Ω , 1%, 1/10W, 0603	NIC, NRC06F7870TRF
30	1	R61	RES., 1.65k, 1%, 1/10W, 0603	NIC, NRC06F1651TRF
31	12	R72-R83	RES., 0 Ω , 1W, 2512, 7A, AEC-Q200	VISHAY, CRCW25120000Z0EG
32	4	R115-R118	RES., 200 Ω , 1%, 1/10W, 0603	VISHAY, CRCW0603200RfKEA
33	6	R119-R124	RES., 127 Ω , 1%, 1/10W, 0603, AEC-Q200	NIC, NRC06F1270TRF
34	4	R126, R127, R131, R132	RES., 0.01 Ω , 1%, 1W, 2512, METAL, SENSE	PANASONIC, ERJM1WSF10MU

DEMO MANUAL

DC2924A-A/DC2924A-B

PARTS LIST DC2924A-B

ITEM	QTY	REFERENCE	PART DESCRIPTION	MANUFACTURER/PART NUMBER
35	1	R128	RES., 0Ω, 1W, 2512, SENSE, COPPER	VISHAY, WSL251200000ZEA9
36	3	R136, R177, R178	RES., 10Ω, 1%, 1/10W, 0603	VISHAY, CRCW060310R0FKEA
37	1	SWR0	SWITCH, SLIDE, DPDT, 0.3A, 6VDC, PTH	C&K, JS202011CQN
38	1	U1	IC, QUAD OUTPUT μModule REG., BGA	ANALOG DEVICES, LTM4681EY#PBF
39	1	U2	IC, MEMORY, EEPROM, 2KBIT (256x8), TSSOP-8, 400kHz	MICROCHIP, 24LC025-I/ST

DC2924A-B Additional Demo Board Circuit Components

1	0	C4, C5, C16, C19, C22, C26-C28	CAP, OPTION, 0603	
2	0	C15, C18, C21, C24	CAP, OPTION, 0805	
3	0	D13-D16	DIODE, OPTION, SOD-323	
4	0	Q1, Q2	XSTR., OPTION, MOSFET, P-CH, SOT-23	
5	0	R5, R9, R111-R114, R129, R133, R134	RES., OPTION, 2512	
6	0	R12, R14, R15, R17, R18, R32, R34-R45, R47, R48, R60, R62-R71, R105-R110, R137-R142, R154, R155, R157-R159, R161-R167, R170-R176	RES., OPTION, 0603	
7	0	R16, R19, R46, R49	RES., OPTION, 0805	
8	0	SWR1-SWR3	SWITCH, SLIDE, DPDT, 0.3A, 6VDC, PTH	C&K, JS202011CQN

DC2924A-B Hardware: For Demo Board Only

1	47	E1-E47	TEST POINT, TURRET, 0.094" MTG. HOLE, PCB 0.062" THK	MILL-MAX, 2501-2-00-80-00-00-07-0
2	6	J11-J16	CONN., RF, BNC, RCPT, JACK, 5-PIN, ST, THT, 50Ω	AMPHENOL RF, 112404
3	1	J17	CONN., HDR, SHROUDED, MALE, 1x4, 2mm, VERT, ST, THT	HIROSE ELECTRIC, DF3A-4P-2DSA
4	1	J18	CONN., HDR, SHROUDED, MALE, 2x6, 2mm, VERT, ST, THT	AMPHENOL, 98414-G06-12ULF
5	1	J19	CONN., HDR, FEMALE, 2x7, 2mm, R/A THT	SULLINS CONNECTOR SOLUTIONS, NPPN072FJFN-RC
6	1	J20	CONN., HDR, MALE, 2x7, 2mm, R/A THT	MOLEX, 0877601416
7	3	JP1-JP3	CONN., HDR, MALE, 1x3, 2mm, VERT, ST, THT, NO SUBS. ALLOWED	WURTH ELEKTRONIK, 62000311121
8	4	MP1-MP4	STANDOFF, NYLON, SNAP-ON, 0.50"	KEYSTONE, 8833
9	3	XJP1-XJP3	CONN., SHUNT, FEMALE, 2 POS, 2mm	WURTH ELEKTRONIK, 60800213421

DEMO MANUAL DC2924A-A/DC2924A-B

SCHEMATIC: DC2924A-A

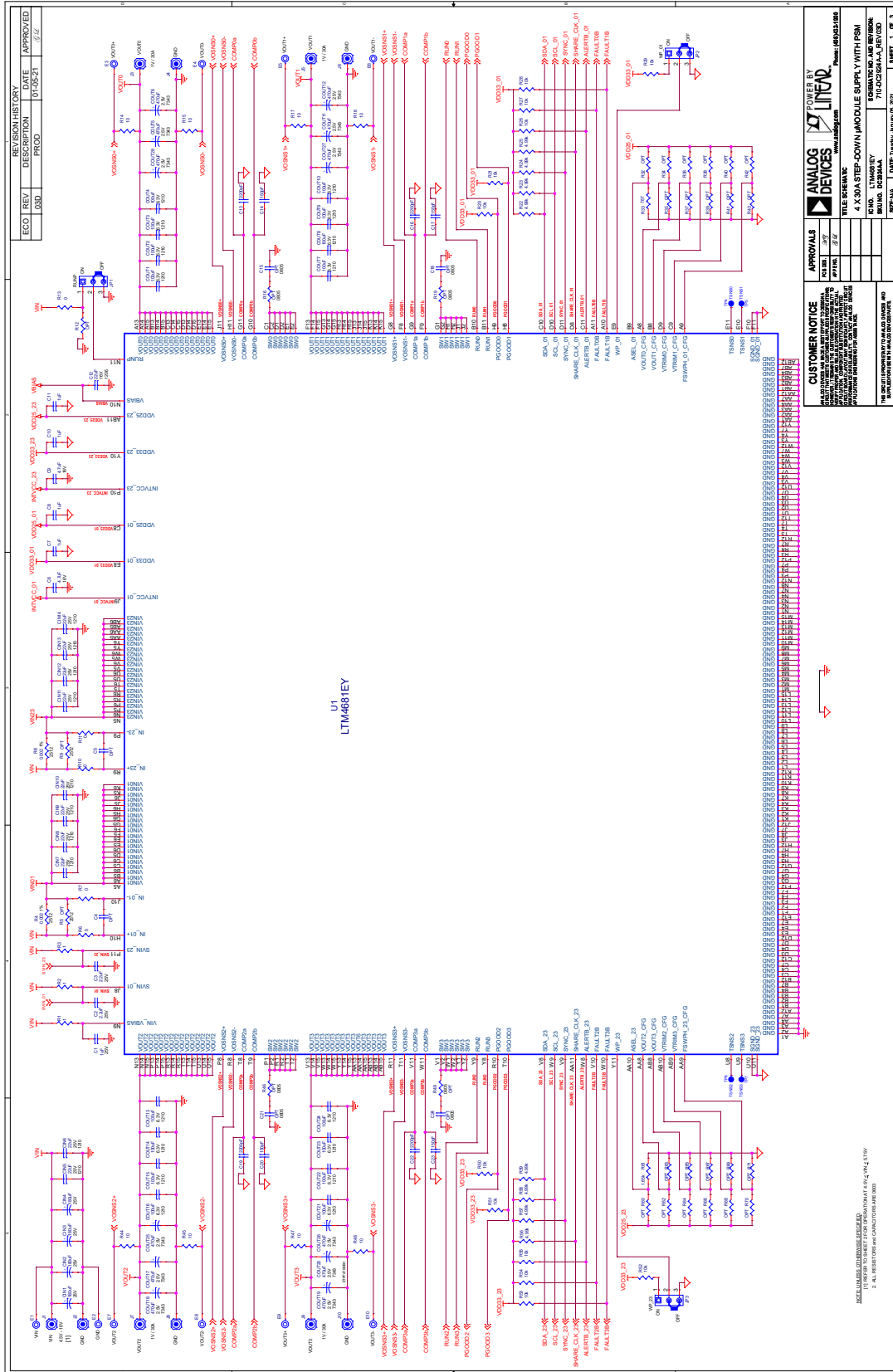
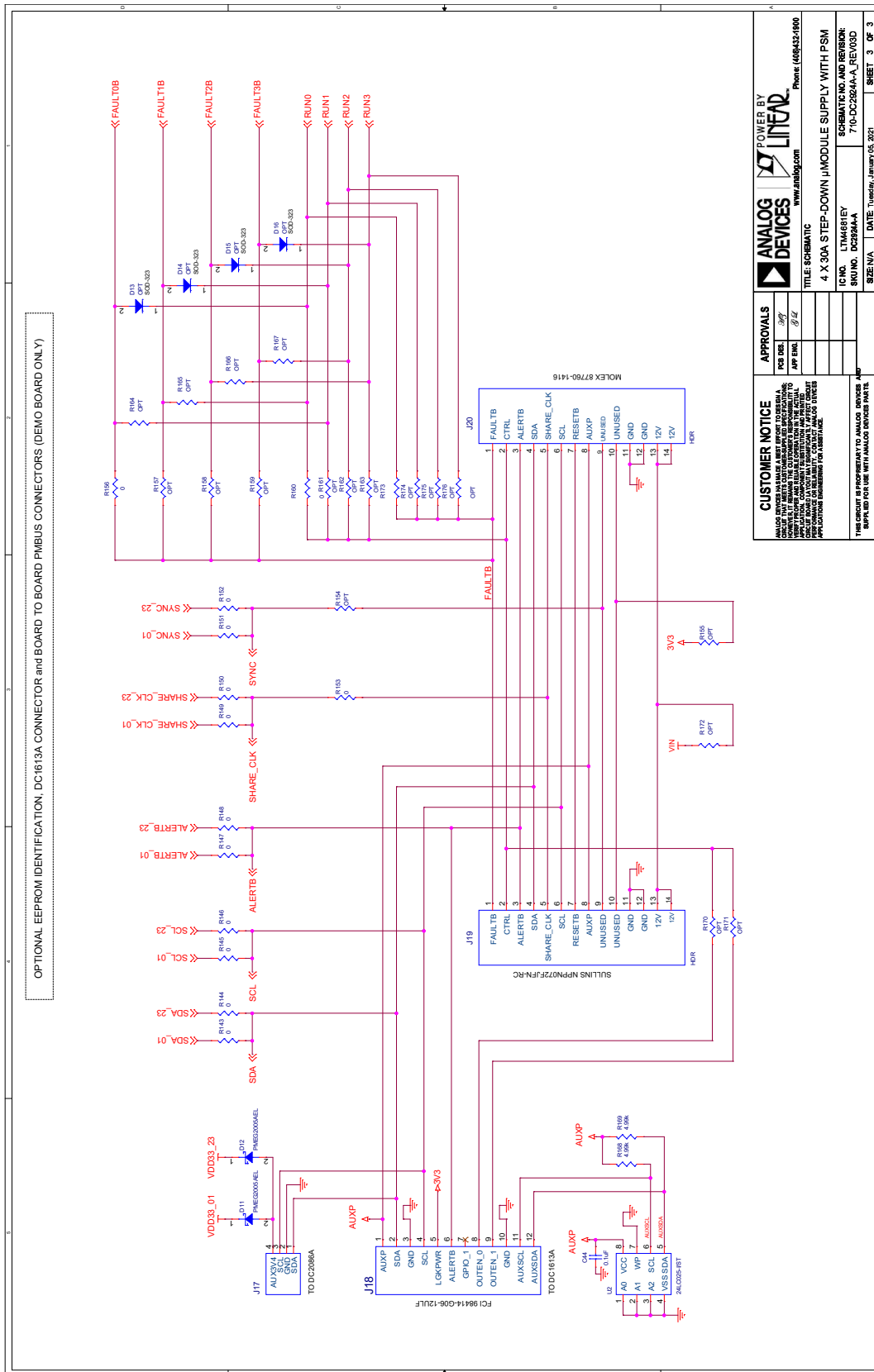

Figure 16. DC2924A-A Demo Circuit Schematic, Sheet 1

DEMO MANUAL DC2924A-A/DC2924A-B

SCHEMATIC: DC2924A-A



SCHEMATIC: DC2924A-B

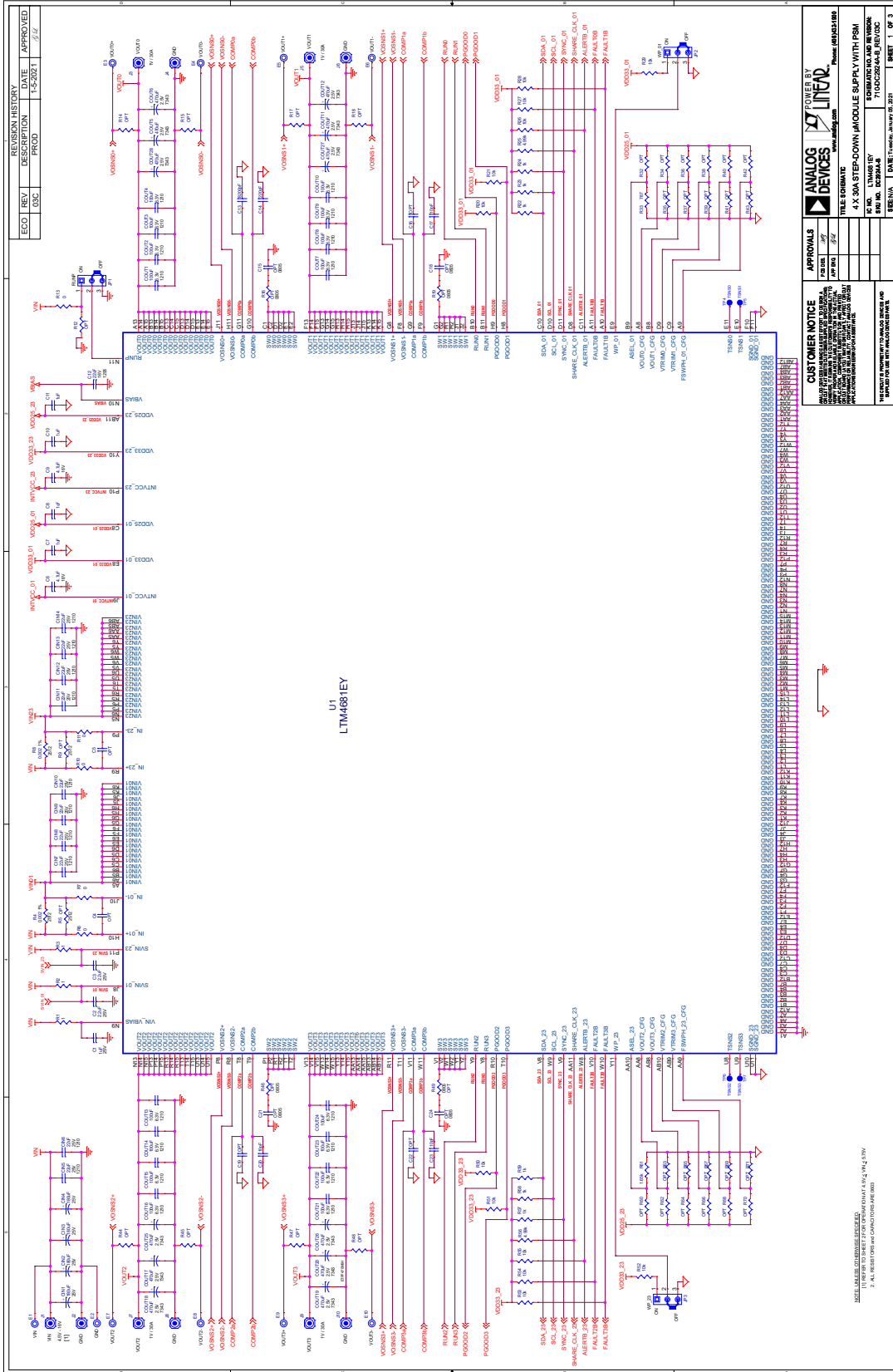
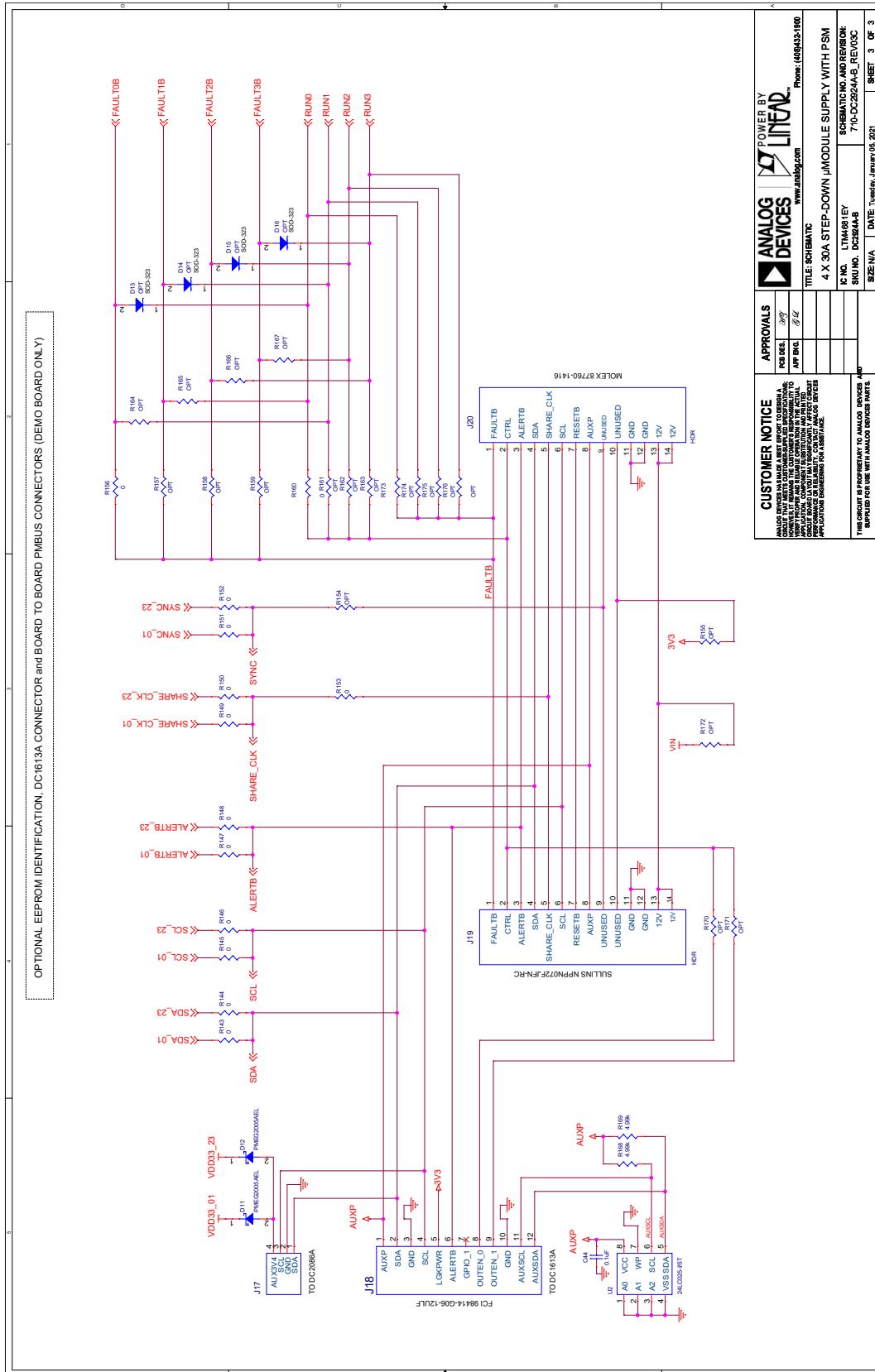

Figure 19. DC2924A-B Demo Circuit Schematic, Sheet 1

SCHEMATIC: DC2924A-B



CUSTOMER NOTICE		APPROVALS	
ANALOG DEVICES MAKES A BEST EFFORT TO DESIGN, DEVELOP, TEST, MANUFACTURE, AND DELIVER HIGH QUALITY PRODUCTS. HOWEVER, ANALOG DEVICES DOES NOT WARRANT OR REPRESENT THAT THE INFORMATION CONTAINED HEREIN IS FREE FROM ERRORS OR OMISSIONS. ANALOG DEVICES ASSUMES NO LIABILITY FOR DAMAGES OF ANY KIND, INCLUDING CONSEQUENTIAL DAMAGES, ARISING FROM THE USE OF THIS INFORMATION.		DESIGNER	DATE
THIS CIRCUIT IS PROPRIETARY TO ANALOG DEVICES AND IS NOT TO BE REPRODUCED OR TRANSMITTED IN ANY FORM OR BY ANY MEANS, ELECTRONIC OR MECHANICAL, INCLUDING PHOTOCOPYING, RECORDING, OR BY ANY INFORMATION STORAGE AND RETRIEVAL SYSTEM.		APP'D	DATE
TITLE: SCHEMATIC		DESIGNED BY	DATE
IC NO. LTM481EY		APP'D	DATE
SKU NO. DC2924A-B		DESIGNED BY	DATE
SIZE: N/A		APP'D	DATE
DATE: Tuesday, January 05, 2021		DESIGNED BY	DATE
SCHEMATIC NO. AND REVISION: 710-DC2924A-B_REV03C		APP'D	DATE
SHEET 3 OF 3		DESIGNED BY	DATE

Figure 21. DC2924A-B Demo Circuit Schematic, Sheet 3

DEMO MANUAL

DC2924A-A/DC2924A-B



ESD Caution

ESD (electrostatic discharge) sensitive device. Charged devices and circuit boards can discharge without detection. Although this product features patented or proprietary protection circuitry, damage may occur on devices subjected to high energy ESD. Therefore, proper ESD precautions should be taken to avoid performance degradation or loss of functionality.

Legal Terms and Conditions

By using the evaluation board discussed herein (together with any tools, components documentation or support materials, the "Evaluation Board"), you are agreeing to be bound by the terms and conditions set forth below ("Agreement") unless you have purchased the Evaluation Board, in which case the Analog Devices Standard Terms and Conditions of Sale shall govern. Do not use the Evaluation Board until you have read and agreed to the Agreement. Your use of the Evaluation Board shall signify your acceptance of the Agreement. This Agreement is made by and between you ("Customer") and Analog Devices, Inc. ("ADI"), with its principal place of business at One Technology Way, Norwood, MA 02062, USA. Subject to the terms and conditions of the Agreement, ADI hereby grants to Customer a free, limited, personal, temporary, non-exclusive, non-sublicensable, non-transferable license to use the Evaluation Board FOR EVALUATION PURPOSES ONLY. Customer understands and agrees that the Evaluation Board is provided for the sole and exclusive purpose referenced above, and agrees not to use the Evaluation Board for any other purpose. Furthermore, the license granted is expressly made subject to the following additional limitations: Customer shall not (i) rent, lease, display, sell, transfer, assign, sublicense, or distribute the Evaluation Board; and (ii) permit any Third Party to access the Evaluation Board. As used herein, the term "Third Party" includes any entity other than ADI, Customer, their employees, affiliates and in-house consultants. The Evaluation Board is NOT sold to Customer; all rights not expressly granted herein, including ownership of the Evaluation Board, are reserved by ADI. CONFIDENTIALITY. This Agreement and the Evaluation Board shall all be considered the confidential and proprietary information of ADI. Customer may not disclose or transfer any portion of the Evaluation Board to any other party for any reason. Upon discontinuation of use of the Evaluation Board or termination of this Agreement, Customer agrees to promptly return the Evaluation Board to ADI. ADDITIONAL RESTRICTIONS. Customer may not disassemble, decompile or reverse engineer chips on the Evaluation Board. Customer shall inform ADI of any occurred damages or any modifications or alterations it makes to the Evaluation Board, including but not limited to soldering or any other activity that affects the material content of the Evaluation Board. Modifications to the Evaluation Board must comply with applicable law, including but not limited to the RoHS Directive. TERMINATION. ADI may terminate this Agreement at any time upon giving written notice to Customer. Customer agrees to return to ADI the Evaluation Board at that time. LIMITATION OF LIABILITY. THE EVALUATION BOARD PROVIDED HEREUNDER IS PROVIDED "AS IS" AND ADI MAKES NO WARRANTIES OR REPRESENTATIONS OF ANY KIND WITH RESPECT TO IT. ADI SPECIFICALLY DISCLAIMS ANY REPRESENTATIONS, ENDORSEMENTS, GUARANTEES, OR WARRANTIES, EXPRESS OR IMPLIED, RELATED TO THE EVALUATION BOARD INCLUDING, BUT NOT LIMITED TO, THE IMPLIED WARRANTY OF MERCHANTABILITY, TITLE, FITNESS FOR A PARTICULAR PURPOSE OR NON-INFRINGEMENT OF INTELLECTUAL PROPERTY RIGHTS. IN NO EVENT WILL ADI AND ITS LICENSORS BE LIABLE FOR ANY INCIDENTAL, SPECIAL, INDIRECT, OR CONSEQUENTIAL DAMAGES RESULTING FROM CUSTOMER'S POSSESSION OR USE OF THE EVALUATION BOARD, INCLUDING BUT NOT LIMITED TO LOST PROFITS, DELAY COSTS, LABOR COSTS OR LOSS OF GOODWILL. ADI'S TOTAL LIABILITY FROM ANY AND ALL CAUSES SHALL BE LIMITED TO THE AMOUNT OF ONE HUNDRED US DOLLARS (\$100.00). EXPORT. Customer agrees that it will not directly or indirectly export the Evaluation Board to another country, and that it will comply with all applicable United States federal laws and regulations relating to exports. GOVERNING LAW. This Agreement shall be governed by and construed in accordance with the substantive laws of the Commonwealth of Massachusetts (excluding conflict of law rules). Any legal action regarding this Agreement will be heard in the state or federal courts having jurisdiction in Suffolk County, Massachusetts, and Customer hereby submits to the personal jurisdiction and venue of such courts. The United Nations Convention on Contracts for the International Sale of Goods shall not apply to this Agreement and is expressly disclaimed.

Rev. 0