

ALF70C301DD500

Aliases (A556EF301M500C)

ALF70, Aluminum Electrolytic, 300 uF, 20%, 500 VDC, -40/+85°C

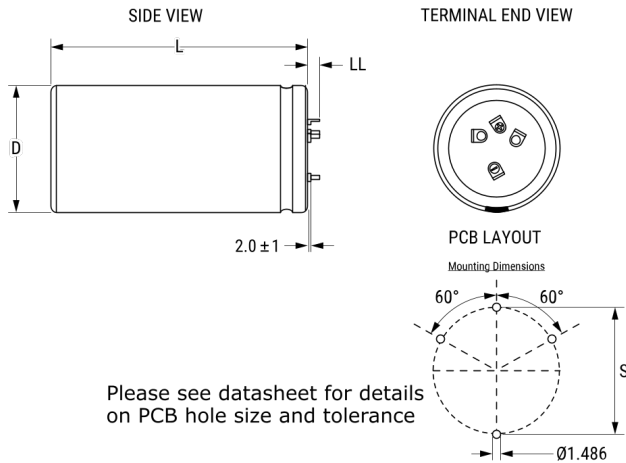

Click [here](#) for the 3D model.

Dimensions

D	35mm +1mm
L	40mm +/-2mm
S	22.5mm +/-0.1mm
LL	5.5mm +/-1mm
F	1.486mm +/-0.076mm

Packaging Specifications

Sleeving	Yes
Packaging	Bulk

General Information

Series	ALF70
Dielectric	Aluminum Electrolytic
Style	Press-Fit
Description	Press-Fit, Aluminum Electrolytic
RoHS	Yes
Lead	4 Pin Press-Fit
AEC-Q200	No
Halogen Free	Yes
Component Weight	65 g
Notes	Dimensions D And L Include Sleeving.
Shelf Life	156 Weeks

Specifications

Capacitance	300 uF
Capacitance Tolerance	20%
Voltage DC	500 VDC, 550 VDC (Surge)
Temperature Range	-40/+85°C
Rated Temperature	85°C
Life	15000 Hrs (Rated Voltage And Ripple Current At 85C), 24000 Hrs (Rated Voltage at 85C)
Resistance	673.8 mOhms (100Hz 20C), 478.2 mOhms (10kHz 20C)
Ripple Current	1.973 Amps (100Hz 85C), 4.152 Amps (10kHz 85C)
Leakage Current	900 uA (5min 20°C)