



EG91 LTE CAT 1

MiniPCIe EG91 LTE CAT 1 Technical Specifications & User Manual



Purpose of the Document

The purpose of this document is to explain the technical specifications and manual for using the miniPCIe EG91 LTE Cat 1 module.

Document History

Version	Author	Date	Description
A	5G HUB	10.01.2022	Initial Document

Table of Contents

Purpose of the Document	2
Document History	2
1 Package Content	4
1.1 LTE Cat 1 miniPCle Package:	4
1.2 Download	4
2 General Description	5
2.1 Overview	5
2.2 Key Features.....	5
2.3 Data Rate.....	5
2.4 Interfaces	5
2.5 Software Features	6
2.6 Protocols	6
2.7 General Features.....	6
2.8 Approvals	6
2.9 Overview Diagrams	7
2.10 Functional Diagram	9
2.11 miniPCle PIN Diagram and Assignment	10
2.12 Pin Description	11
2.13 Operating Models	12
2.14 Power Saving.....	13
2.14.1 Sleep Mode	13
2.15 Airplane Mode	13

1 Package Content

1.1 LTE Cat 1 miniPCle Package:

- EG91-NA miniPCle card.

1.2 Download

Download and Install LTE&GNSS modem driver for Windows OS:

<https://github.com/5ghub/5G-NB-IoT/tree/master/Driver>

Download and Install QNavigator and QCOM tools for Quectel EG91 here:

<https://github.com/5ghub/5G-NB-IoT/tree/master/Tools>

Arduino software can be downloaded from the following website:

[5G-NB-IoT/KitSketches at master · 5ghub/5G-NB-IoT \(github.com\)](https://github.com/5ghub/5G-NB-IoT/tree/master/KitSketches)

To use the board with Arduino IDE and starts running Arduino projects and sketches, install the following software:

Install Arduino IDE for Windows from the following web site

<https://www.arduino.cc/en/Main/Software>

Download and install Arduino library (**5G-NB-IoT_Arduino.zip**) here:

<https://github.com/5ghub/5G-NB-IoT>

All the following software can be installed from the GitHub location here:

<https://github.com/5ghub/5G-NB-IoT>

[LTE cellular connectivity on Windows OS for BG95](#)

2 General Description

2.1 Overview

EG91 miniPCIe is a series of LTE category 1 module adopting standard PCI Express Mini Card form factor (Mini PCIe). It is optimized specially for M2M and IoT applications and delivers 10Mbps downlink and 5Mbps uplink data rates.

EG91 miniPCIe supports Qualcomm® IZat™ location technology Gen8C Lite (GPS, GLONASS, BeiDou, Galileo and QZSS). The integrated GNSS greatly simplifies product design, and provides quicker, more accurate and more dependable positioning.

A rich set of Internet protocols, industry-standard interfaces, and abundant functionalities (USB serial drivers for Windows 7/8/8.1/10, Linux, Android) extend the applicability of the module to a wide range of M2M applications such as industrial router, industrial PDA, rugged tablet PC, video surveillance and digital signage.

2.2 Key Features

- LTE category 1 module optimized for broadband IoT applications
- Worldwide LTE, UMTS/HSPA+ and GSM/GPRS/EDGE coverage
- Standard PCI Express® MiniCard form factor (miniPCIe) ideal for manufacturers to easily integrate wireless connectivity into their devices
- MIMO technology meets demands for data rate and link reliability in modem wireless communication systems
- Multi-constellation GNSS receiver available for applications requiring fast and accurate fixes in any environment
- LTE FDD: B2/B4/B5/B12/B13
- WCDMA: B2/B4/B5

2.3 Data Rate

- LTE
LTE FDD: Max 10Mbps (DL)/Max 5Mbps (UL)
- UMTS:
DC-HSDPA: Max 42Mbps (DL)
HSUPA: Max 5.76Mbps (UL)
- WCDMA:
Max 384Kbps (DL)/Max 384Kbps (UL)
- GSM:
EDGE: Max 296Kbps (DL)/Max 236.8Kbps (UL)
GPRS: Max 107Kbps (DL)/Max 85.6Kbps (UL)

2.4 Interfaces

- USB 2.0 with High Speed up to 480Mbps
- Digital Audio through PCM
- 1.8V/3.0V (U)SIM Interface
- LED_WWAN# for Network Status Indication
- W_DISABLE# for Disabling RF Function

- UART × 1
- PERST# for Module Resetting
- Solder Pads for Main Antenna, Rx-diversity and
- GNSS Antennas

2.5 Software Features

- USB Serial Driver:
Windows 7/8/8.1/10, Linux 2.6/3.x/4.1~4.15,
Android 4.x/5.x/6.x/7.x/8.x/9.x
- RIL Driver:
Android 4.x/5.x/6.x/7.x/8.x/9.x
- NIDS Driver:
Windows 7/8/8.1/10
- ECM Driver*^⑤:
Linux 2.6/3.x/4.1~4.15
- Gobinet Driver:
Linux 2.6/3.x/4.1~4.15
- Linux qmi wwan Driver:
3.x (3.4 or later)/4.1~4.15

2.6 Protocols

- TCP/UDP/PPP/FTP/FTPS/HTTP/HTTPS/NTP/PING/QMI/NITZ/MMS/SMTP/SSL/MQTT/FILE/CMUX
/SMTPS

2.7 General Features

- Temperature Range: -40°C ~ +80°C
- Dimensions: 30.0mm x 51.0mm x 3.5mm
- Weight: Approx. 9.8g
- Mini PCIe Package
- Supply Voltage: 3.0V~3.6V, 3.3V Typ.
- 3GPP E-UTRA Release 12
- Bandwidth: 1.4/3/5/10/15/20MHz
- 3GPP TS 27.007

2.8 Approvals

- Carrier:
Vodafone (Global)
Deutsche Telekom/Telefónica (Europe)
Verizon/AT&T/T-Mobile/U.S. Cellular (North America)
Rogers/Bell*/Telus* (Canada)
SKT/KT*/LGU+* (South Korea)
NTT DOCOMO/SoftBank/KDDI (Japan)
- Regulatory:
GCF (Global)

- CE (Europe)
- FCC/PTCRB (North America)
- IC (Canada)
- Anatel (Brazil)
- KC (South Korea)
- NCC (Taiwan)
- JATE/TELEC (Japan)
- RCM (Australia/New Zealand)
- FAC (Russia)
- NBTC (Thailand)
- ICASA (South Africa)
- Others:
 - RoHS Compliant
 - WHQL

2.9 Overview Diagrams

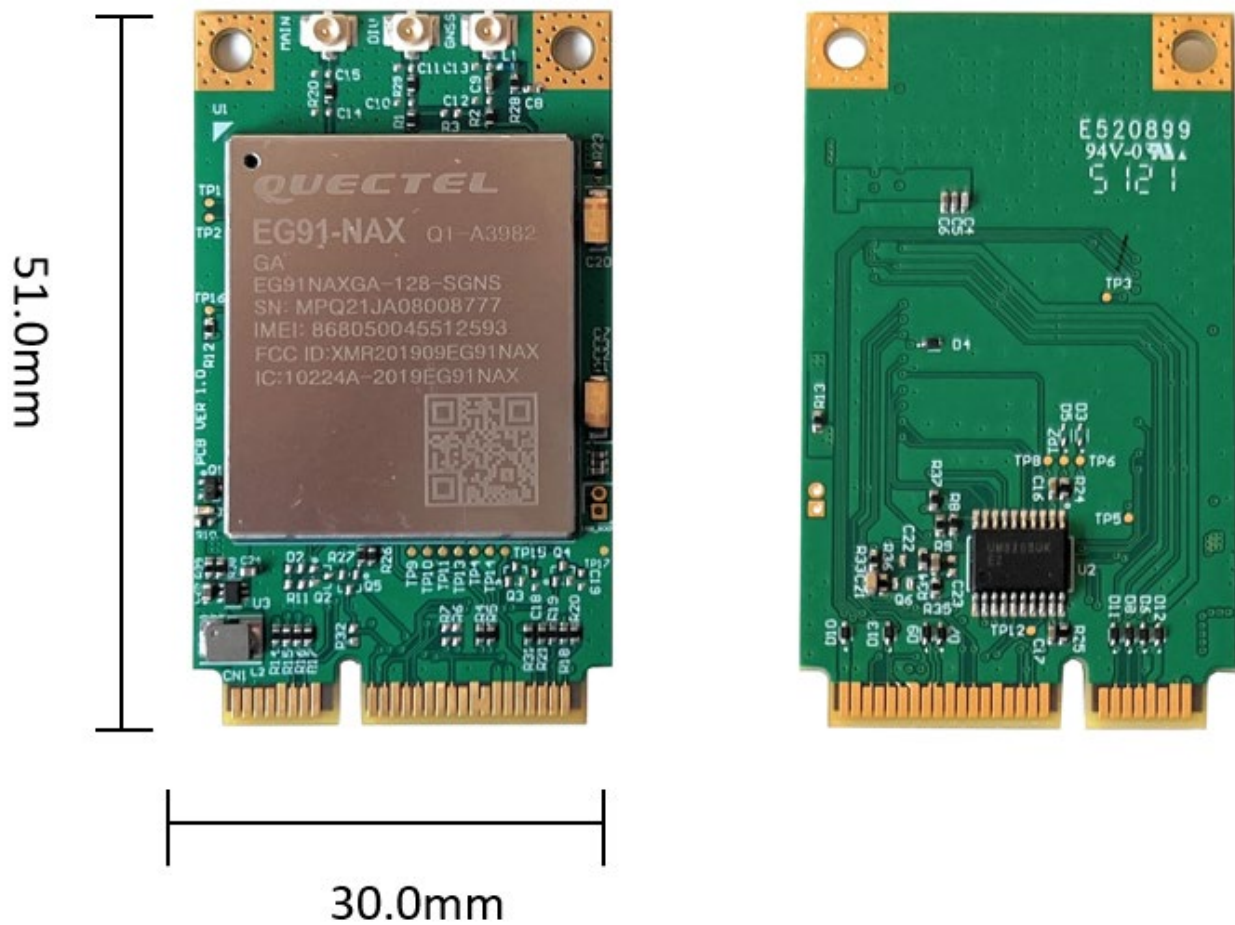

Figure 1. miniPCIe EG91 LTE Cat 1 module.

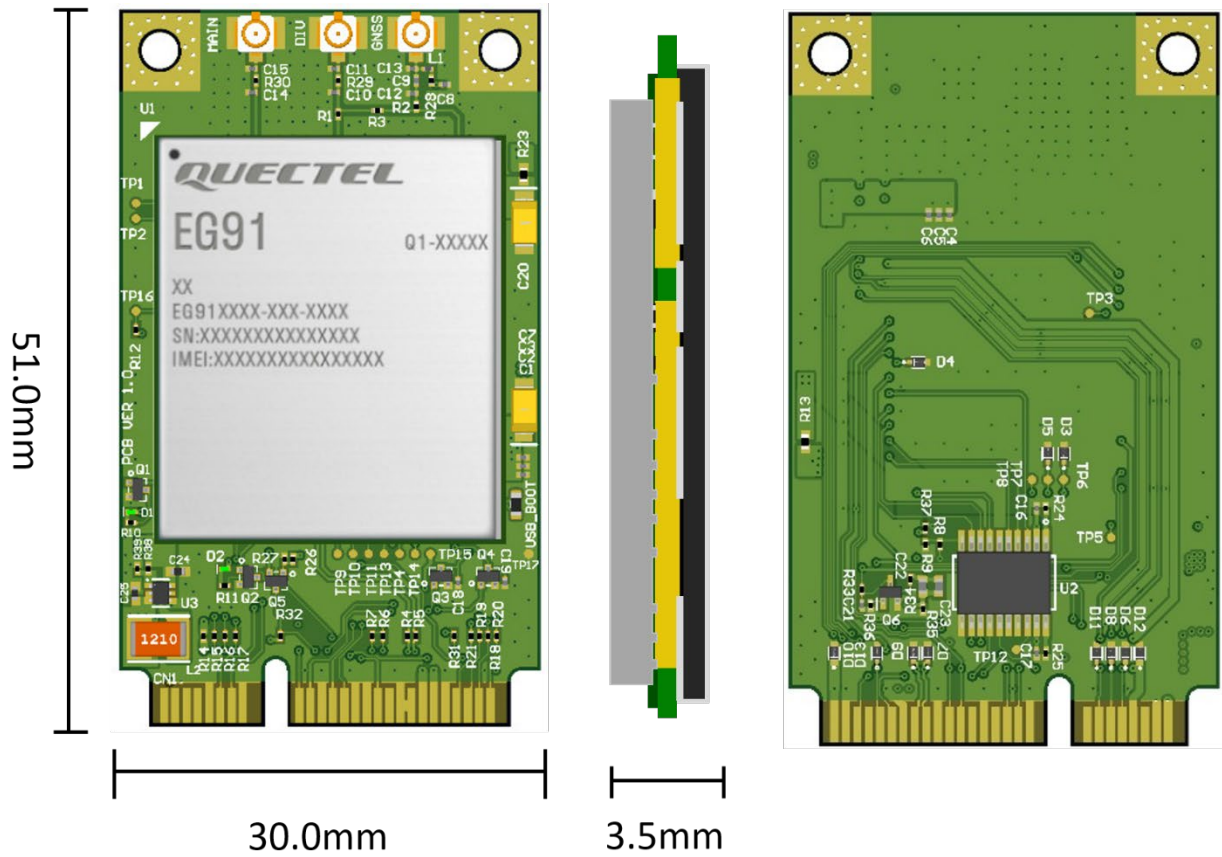

Figure 2. miniPCIe EG91 LTE Cat 1 module physical dimension.

2.10 Functional Diagram

The following figure shows the block diagram of EG91 Mini PCIe.

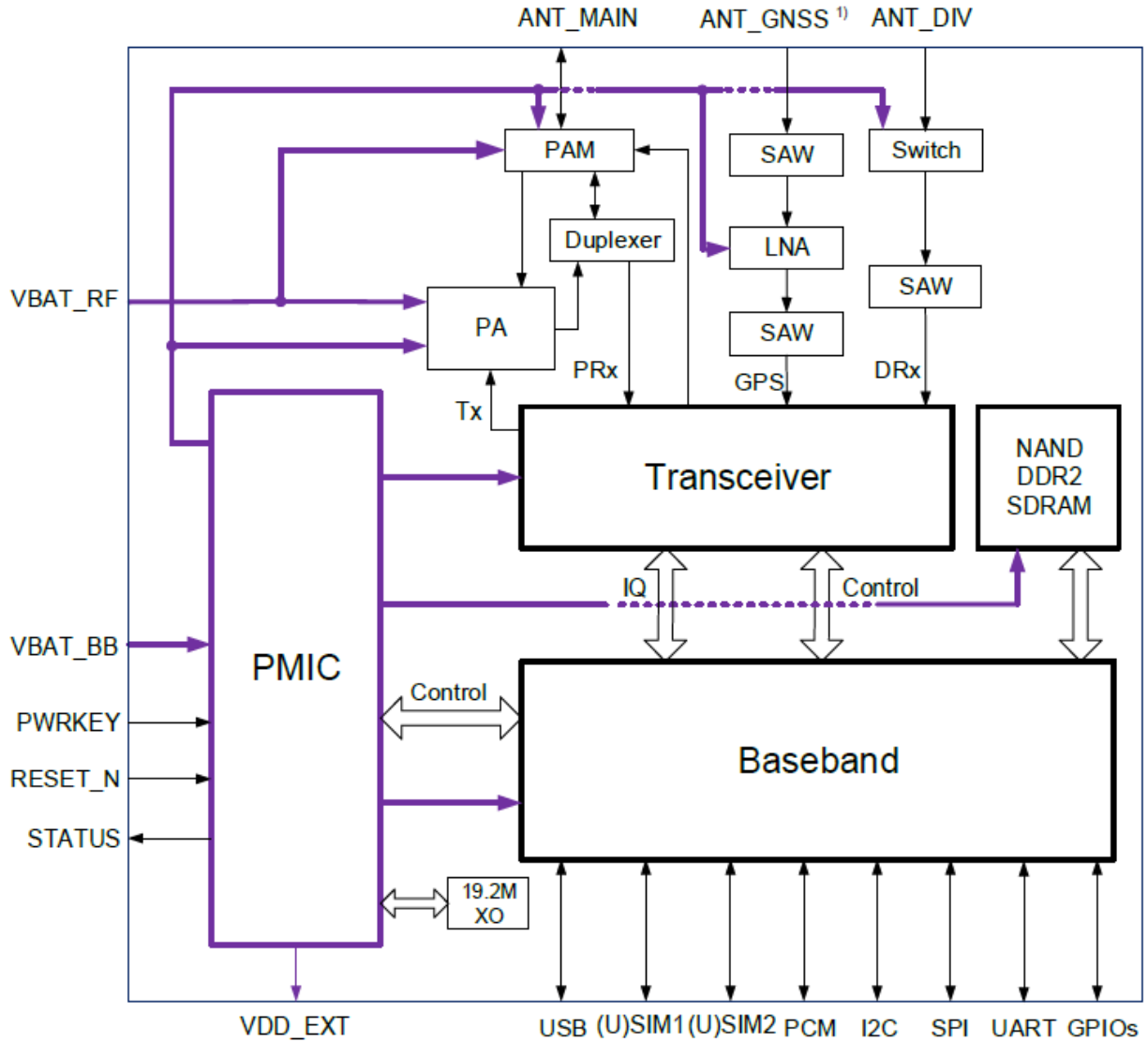

Figure 3. Physical Characteristics.

2.11 miniPCIe PIN Diagram and Assignment

The physical connections and signal levels of EG91 miniPCIe comply with PCI Express Mini Card Electromechanical Specification.

- Power supply
- (U)SIM interface
- USB interface
- UART interfaces
- PCM and I2C interfaces
- Control and indication pins

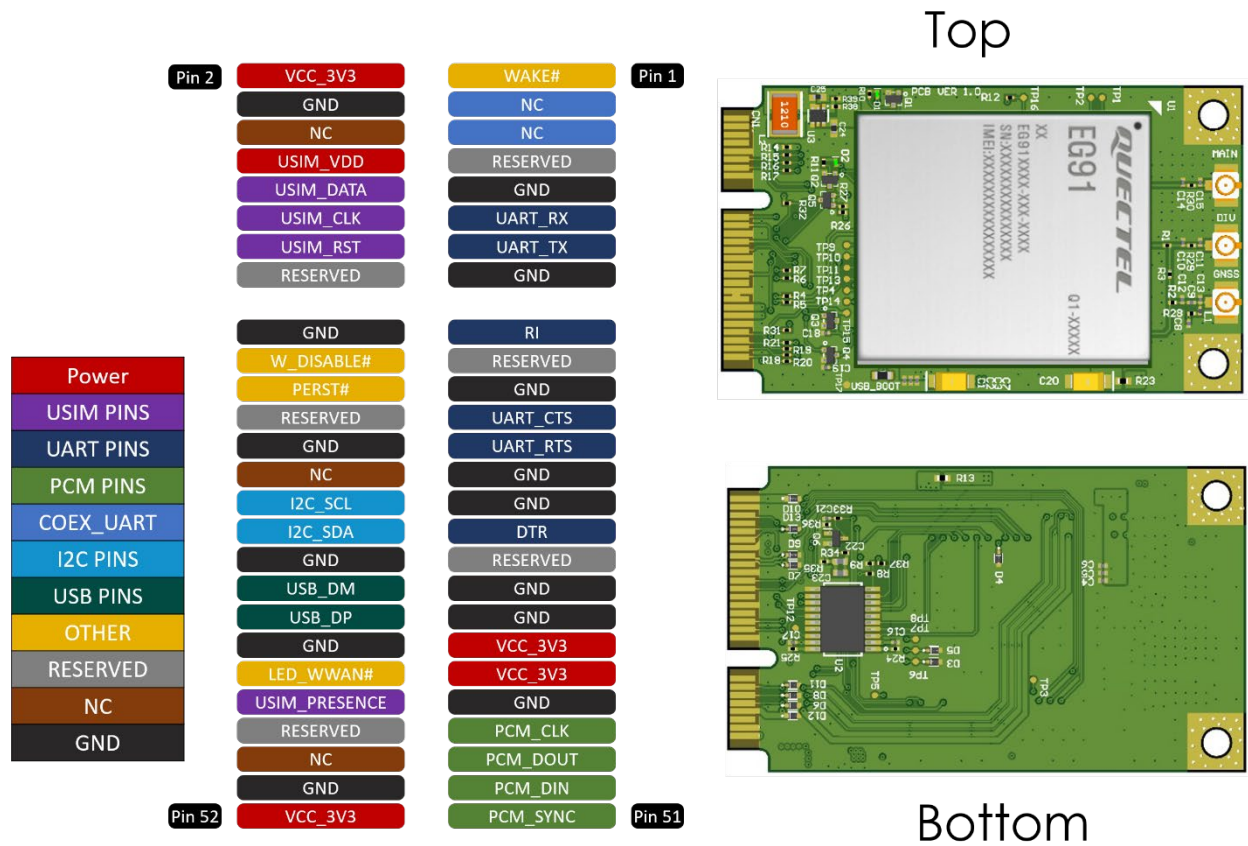

Figure 4. miniPCIe Pin Assignment

2.12 Pin Description

Pin #	Pin Name	Pin Direction	Pin Functionality
1	NC		
2	VCC_3V3	I	3.0V~3.6V, typically 3.3V DC supply
3	NC		
4	GND		Mini card ground
5	NC		
6	NC		Not connected
7	RESERVED		Reserved
8	USIM_VDD	O	Power supply for the (U)SIM card
9	GND		
10	USIM_DATA	I	Data signal of (U)SIM card
11	UART_RX	I	UART receive data
12	USIM_CLK	O	Clock signal of (U)SIM card
13	UART_TX	O	UART transmit data
14	USIM_RST	O	Reset signal of (U)SIM card
15	GND		
16	RESERVED		
17	RI	O	Ring indication
18	GND		
19	RESERVED		
20	W_DISABLE#	I	Airplane mode control
21	GND		
22	PERST#	I	Fundamental reset signal
23	UART_CTS	I	UART clear to send
24	RESERVED		
25	UART_RTS	O	UART request to send
26	GND		
27	GND		
28	NC		
29	GND		
30	I2C_SCL	OD	I2C serial clock
31	DTR	DI	Sleep mode control
32	I2C_SDA	OD	OD I2C serial data
33	RESERVED		
34	GND		
35	GND		
36	USB_DM	IO	USB differential data (-)
37	GND		
38	USB_DP	IO	USB differential data (+)

39	VCC_3V3	I	3.0V~3.6V, typically 3.3V DC supply
40	GND		
41	VCC_3V3	I	3.0V~3.6V, typically 3.3V DC supply
42	LED_WWAN#	OC	LED signal for indicating the network status of the module
43	GND		
44	NC		(U)SIM card insertion detection
45	PCM_CLK	IO	PCM clock signal
46	RESERVED		
47	PCM_DOUT	O	PCM data output
48	NC		
49	PCM_DIN	I	PCM data input
50	GND		
51	PCM_SYNC	IO	PCM frame synchronization
52	VCC_3V3	PI	3.0V~3.6V, typically 3.3V DC supply

2.13 Operating Models

The following table briefly outlines the operating modes to be mentioned in the following chapters.

Mode	Detail	
Normal Operation	Idle	Software is active. The module has registered on the network, and it is ready to send and receive data
	Talk/Data	Network connection is ongoing. In this mode, the power consumption is decided by network setting and data transfer rate.
Minimum Functionality Mode	AT+CFUN command can set the module to a minimum functionality mode without removing the power supply. In this case, both RF function and (U)SIM card will be invalid.	
Airplane Mode	AT+CFUN command or W_DISABLE# pin can set the module to airplane mode. In this case, RF function will be invalid.	
Sleep Mode	In this mode, the current consumption of the module will be reduced to the minimal level. In this mode, the module can still receive paging message, SMS, voice call and TCP/UDP data from the network normally	
Power Down Mode	In this mode, the power management unit shuts down the power supply. Software goes inactive. The serial interface is not accessible. Operating voltage remains applied	

2.14 Power Saving

2.14.1 Sleep Mode

EG91 Mini PCIe can reduce its current consumption to a minimum value in sleep mode. There are three preconditions must be met to make the module enter sleep mode.

- Execute **AT+QCLK=1** to enable sleep mode
- Ensure the DTR is kept at high level or be kept open
- The host's USB bus, which is connected with the module's USB interface, enters suspendstate

2.15 Airplane Mode

When the module enters airplane mode, the RF function will be disabled, and all AT commands related to it will be inaccessible.