

Data sheet | Item number: 285-134

2-conductor through terminal block; 35 mm²; lateral marker slots; only for DIN 35 x 15 rail; POWER CAGE CLAMP; 35,00 mm²; blue

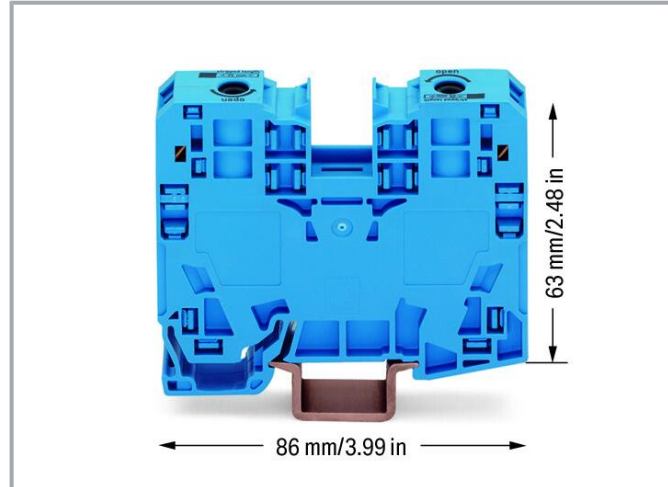

www.wago.com/285-134

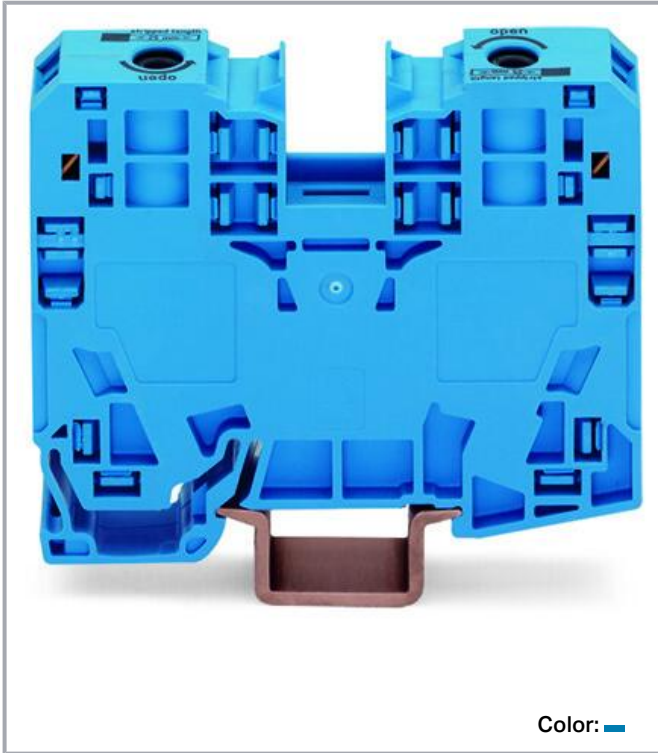

Data

Electrical data

Ratings per IEC/EN

Ratings per	IEC/EN 60947-7-1
Nominal voltage (III/3)	1000 V
Rated impulse voltage (III/3)	8 kV
Rated current	125 A
Legend (ratings)	(III / 3) ≙ Overvoltage category III / Pollution degree 3

Ratings per UL 1059

Approvals per	UL 1059
Rated voltage UL (Use Group B)	600 V

Subject to changes. Please also observe the further product documentation!

WAGO GmbH & Co. KG
Hansastr. 27
32423 Minden
Phone: +49571 887-0 | Fax: +49571 887-169
Email: info.de@wago.com | Web: www.wago.com

Do you have any questions about our products?
We are always happy to take your call at +49 (571) 887-44222.



Rated current UL (Use Group B)	115 A
Rated voltage UL (Use Group C)	600 V
Rated current UL (Use Group C)	115 A

Ratings per CSA

Approvals per	CSA 22.2 No 158
Rated voltage CSA (Use Group B)	600 V
Rated current CSA (Use Group B)	115 A
Rated voltage CSA (Use Group C)	600 V
Rated current CSA (Use Group D)	115 A

Power loss

Power loss, per pole (potential)	4.062 W
Rated current I_N for specified power loss	125 A
Resistance value for specified, current-dependent power loss	0 Ω

Connection data

Connection points	2
Total number of potentials	1
Number of levels	1
Number of jumper slots	2

Connection 1

Connection technology	POWER CAGE CLAMP
Actuation type	Operating tool
Connectable conductor materials	Copper
Solid conductor	6 ... 35 mm ² / 8 ... 2 AWG
Stranded conductor	6 ... 35 mm ² / 8 ... 2 AWG
Fine-stranded conductor	6 ... 35 mm ² / 8 ... 2 AWG
Fine-stranded conductor; with insulated ferrule	6 ... 35 mm ² / 8 ... 2 AWG
Fine-stranded conductor; with uninsulated ferrule	6 ... 35 mm ² / 8 ... 2 AWG
Strip length	25 mm / 0.98 inches
Wiring direction	Side-entry wiring

Physical data

Width	16 mm / 0.63 inches
-------	---------------------

Subject to changes. Please also observe the further product documentation!



Height	86 mm / 3.386 inches
Depth from upper-edge of DIN-rail	63 mm / 2.48 inches

Mechanical Data

Mounting type	DIN-rail 35 x 15
Mounting (note)	only suitable for DIN 35 x 15 rail
Marking level	Side marking

Material Data

Note (material data)	Information on material specifications can be found here
Color	blue
Material group	I
Insulation material	Polyamide (PA66)
Flammability class per UL94	V0
Fire load	1.252 MJ
Weight	79.3 g

Environmental requirements

Processing temperature	-35 ... +85 °C
Continuous operating temperature	-60 ... +105 °C

Commercial data

Product Group	1 (Rail Mounted Terminal Blocks)
eCl@ss 10.0	27-14-11-20
eCl@ss 9.0	27-14-11-20
ETIM 8.0	EC000897
ETIM 7.0	EC000897
PU (SPU)	15 pcs
Packaging type	box
Country of origin	PL
GTIN	4045454507398
Customs tariff number	85369010000

Environmental Product Compliance

RoHS Compliance Status	Compliant, No Exemption
------------------------	-------------------------





Subject to changes. Please also observe the further product documentation!

WAGO GmbH & Co. KG
 Hansastr. 27
 32423 Minden
 Phone: +49571 887-0 | Fax: +49571 887-169
 Email: info.de@wago.com | Web: www.wago.com



Do you have any questions about our products?
 We are always happy to take your call at +49 (571) 887-44222.

Approvals / Certificates

General approvals

Logo	Approval	Additional Approval Text	Certificate name
	CCA DEKRA Certification B.V.	EN 60947	NTR NL-7707
	CSA DEKRA Certification B.V.	C22.2 No. 158	154112
	KEMA/KEUR DEKRA Certification B.V.	EN 60947	71-105562
	UL Underwriters Laboratories Inc.	UL 1059	E45172

Declarations of conformity and manufacturer's declarations

Logo	Approval	Additional Approval Text	Certificate name
	EU-Declaration of Conformity WAGO GmbH & Co. KG	-	-
	UK-Declaration of Conformity WAGO GmbH & Co. KG	-	-

Approvals for marine applications

Logo	Approval	Additional Approval Text	Certificate name
	ABS American Bureau of Shipping	EN 60947	20-HG1941090-PDA
	DNV GL Det Norske Veritas, Germanischer Lloyd	-	TAE00001V2

Subject to changes. Please also observe the further product documentation!

WAGO GmbH & Co. KG
Hansastr. 27
32423 Minden
Phone: +49571 887-0 | Fax: +49571 887-169
Email: info.de@wago.com | Web: www.wago.com

Do you have any questions about our products?
We are always happy to take your call at +49 (571) 887-44222.



LR
Lloyds Register

EN 60947

91/20112
(E9)

Optional accessories

Carrier rail

Mounting accessories



Item no.: 210-197

Steel carrier rail; 35 x 15 mm; 1.5 mm thick; 2 m long; slotted; similar to EN 60715; silver-colored

www.wago.com/210-197

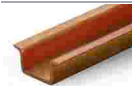

Item no.: 210-198

Copper carrier rail; 35 x 15 mm; 2.3 mm thick; 2 m long; unslotted; according to EN 60715; copper-colored

www.wago.com/210-198



Item no.: 210-506

Steel carrier rail; 35 x 15 mm; 1.5 mm thick; 2 m long; unslotted; galvanized; similar to EN 60715; silver-colored

www.wago.com/210-506



Item no.: 210-508

Steel carrier rail; 35 x 15 mm; 1.5 mm thick; 2 m long; slotted; galvanized; similar to EN 60715; silver-colored

www.wago.com/210-508



Item no.: 210-118

Steel carrier rail; 35 x 15 mm; 2.3 mm thick; 2 m long; unslotted; according to EN 60715; silver-colored

www.wago.com/210-118



Item no.: 210-114

Steel carrier rail; 35 x 15 mm; 1.5 mm thick; 2 m long; unslotted; similar to EN 60715; silver-colored

www.wago.com/210-114

Tool

Operating tool



Item no.: 210-721

Operating tool; Blade: 5.5 x 0.8 mm; with a partially insulated shaft; multicoloured

www.wago.com/210-721

Mounting

Mounting accessories



Item no.: 249-117

Screwless end stop; 10 mm wide; for DIN-rail 35 x 15 and 35 x 7.5; gray

www.wago.com/249-117

Subject to changes. Please also observe the further product documentation!

WAGO GmbH & Co. KG

Hansastr. 27

32423 Minden

Phone: +49571 887-0 | Fax: +49571 887-169

Email: info.de@wago.com | Web: www.wago.com

Do you have any questions about our products?

We are always happy to take your call at +49 (571) 887-44222.



Item no.: 249-197

Screwless end stop; 14 mm wide; for DIN-rail 35 x 15 and 35 x 7.5; gray

www.wago.com/249-197

Testing and measuring

Testing accessories



Item no.: 283-404

Test plug adapter; 11.6 mm wide; for 4 mm Ø test plugs; gray

www.wago.com/283-404

Cover

Cover



Item no.: 285-421

Finger guard; touchproof cover protects unused conductor entries; for 35 mm² high-current tbs; yellow

www.wago.com/285-421

Protective warning marker

Cover



Item no.: 285-420

Protective warning marker; with high-voltage symbol, black; yellow

www.wago.com/285-420

Voltage tap

Power tap



Item no.: 283-407

Power tap; with 500 mm cable; for 16 mm² (283/783 Series) and 35 mm²; gray

www.wago.com/283-407



Item no.: 285-427

Power tap; for 35 mm² high-current tbs; Module width 8 mm; 6,00 mm²; gray

www.wago.com/285-427

Jumpers

Jumper



Item no.: 285-430

Step-down jumper; from 285 (35mm²) to 2016/2010 series; insulated; gray

www.wago.com/285-430



Item no.: 285-435

Jumper; insulated; gray

www.wago.com/285-435

Ferrule

Ferrule



Item no.: 216-413

Ferrule; Sleeve for 25 mm² / AWG 4; uninsulated; electro-tin plated; electrolytic copper; gastight crimped; acc. to DIN 46228, Part 1/08.92; silver-colored

www.wago.com/216-413



Item no.: 216-414

Ferrule; Sleeve for 35 mm² / AWG 2; uninsulated; electro-tin plated; electrolytic copper; gastight crimped; acc. to DIN 46228, Part 1/08.92; silver-colored

www.wago.com/216-414

Marking accessories

Marking strip

Subject to changes. Please also observe the further product documentation!

WAGO GmbH & Co. KG

Hansastr. 27

32423 Minden

Phone: +49571 887-0 | Fax: +49571 887-169

Email: info.de@wago.com | Web: www.wago.com

Do you have any questions about our products?

We are always happy to take your call at +49 (571) 887-44222.



Item no.: 2009-110
 Marking strips; for Smart Printer; on reel; not stretchable; plain; snap-on type; white

www.wago.com/2009-110

Marker carrier



Item no.: 285-442
 Adaptor; gray

www.wago.com/285-442

Marker



Item no.: 2009-115/000-002
 WMB-Inline; for Smart Printer; 1500 pieces on roll; stretchable 5 - 5.2 mm; plain; snap-on type; yellow

www.wago.com/2009-115/000-002



Item no.: 2009-115/000-007
 WMB-Inline; for Smart Printer; 1500 pieces on roll; stretchable 5 - 5.2 mm; plain; snap-on type; gray

www.wago.com/2009-115/000-007



Item no.: 2009-115/000-017
 WMB-Inline; for Smart Printer; 1500 pieces on roll; stretchable 5 - 5.2 mm; plain; snap-on type; light green

www.wago.com/2009-115/000-017



Item no.: 2009-115/000-023
 WMB-Inline; for Smart Printer; 1500 pieces on roll; stretchable 5 - 5.2 mm; plain; snap-on type; green

www.wago.com/2009-115/000-023



Item no.: 2009-115/000-024
 WMB-Inline; for Smart Printer; 1500 pieces on roll; stretchable 5 - 5.2 mm; plain; snap-on type; violet

www.wago.com/2009-115/000-024



Item no.: 2009-115
 WMB-Inline; for Smart Printer; 1500 pieces on roll; stretchable 5 - 5.2 mm; plain; snap-on type; white

www.wago.com/2009-115



Item no.: 793-5501/000-007
 WMB marking card; as card; for terminal block width 5 - 17.5 mm; stretchable 5 - 5.2 mm; plain; snap-on type; gray

www.wago.com/793-5501/000-007



Item no.: 793-5501/000-012
 WMB marking card; as card; for terminal block width 5 - 17.5 mm; stretchable 5 - 5.2 mm; plain; snap-on type; orange

www.wago.com/793-5501/000-012



Item no.: 793-5501/000-014
 WMB marking card; as card; for terminal block width 5 - 17.5 mm; stretchable 5 - 5.2 mm; plain; snap-on type; brown

www.wago.com/793-5501/000-014

Item no.: 793-5501/000-017

Subject to changes. Please also observe the further product documentation!



WMB marking card; as card; for terminal block width 5 - 17.5 mm; stretchable 5 - 5.2 mm; plain; snap-on type; light green www.wago.com/793-5501/000-017



Item no.: 793-5501/000-023
WMB marking card; as card; for terminal block width 5 - 17.5 mm; stretchable 5 - 5.2 mm; plain; snap-on type; green www.wago.com/793-5501/000-023



Item no.: 793-5501/000-024
WMB marking card; as card; for terminal block width 5 - 17.5 mm; stretchable 5 - 5.2 mm; plain; snap-on type; violet www.wago.com/793-5501/000-024



Item no.: 793-501/000-002
WMB marking card; as card; not stretchable; plain; snap-on type; yellow www.wago.com/793-501/000-002



Item no.: 793-501/000-007
WMB marking card; as card; not stretchable; plain; snap-on type; gray www.wago.com/793-501/000-007



Item no.: 793-501/000-017
WMB marking card; as card; not stretchable; plain; snap-on type; light green www.wago.com/793-501/000-017



Item no.: 793-501/000-012
WMB marking card; as card; not stretchable; plain; snap-on type; orange www.wago.com/793-501/000-012



Item no.: 793-501/000-023
WMB marking card; as card; not stretchable; plain; snap-on type; green www.wago.com/793-501/000-023



Item no.: 793-501/000-006
WMB marking card; as card; not stretchable; plain; snap-on type; blue www.wago.com/793-501/000-006



Item no.: 793-501/000-005
WMB marking card; as card; not stretchable; plain; snap-on type; red www.wago.com/793-501/000-005



Item no.: 793-501
WMB marking card; as card; not stretchable; plain; snap-on type; white www.wago.com/793-501

Subject to changes. Please also observe the further product documentation!



Item no.: 793-501/000-024
WMB marking card; as card; not stretchable; plain; snap-on type; violet

www.wago.com/793-501/000-024



Item no.: 793-5501/000-005
WMB marking card; as card; for terminal block width 5 - 17.5 mm; stretchable 5 - 5.2 mm; plain; snap-on type; red

www.wago.com/793-5501/000-005



Item no.: 793-5501/000-002
WMB marking card; as card; for terminal block width 5 - 17.5 mm; stretchable 5 - 5.2 mm; plain; snap-on type; yellow

www.wago.com/793-5501/000-002



Item no.: 793-5501/000-006
WMB marking card; as card; for terminal block width 5 - 17.5 mm; stretchable 5 - 5.2 mm; plain; snap-on type; blue

www.wago.com/793-5501/000-006



Item no.: 793-5501
WMB marking card; as card; for terminal block width 5 - 17.5 mm; stretchable 5 - 5.2 mm; plain; snap-on type; white

www.wago.com/793-5501



Item no.: 2009-115/000-012
WMB-Inline; for Smart Printer; 1500 pieces on roll; stretchable 5 - 5.2 mm; plain; snap-on type; orange

www.wago.com/2009-115/000-012



Item no.: 2009-115/000-006
WMB-Inline; for Smart Printer; 1500 pieces on roll; stretchable 5 - 5.2 mm; plain; snap-on type; blue

www.wago.com/2009-115/000-006



Item no.: 2009-115/000-005
WMB-Inline; for Smart Printer; 1500 pieces on roll; stretchable 5 - 5.2 mm; plain; snap-on type; red

www.wago.com/2009-115/000-005

Group marker carrier



Item no.: 249-105
Group marker carrier; gray

www.wago.com/249-105

Downloads
Documentation

Bid Text

285-134	2019 Feb 19	xml	Download
X81 - Datei		3.3 kB	
285-134	2018 Jan 4	doc	Download

Subject to changes. Please also observe the further product documentation!



doc - Datei

24.1 kB

Additional Information

Technical Section

pdf

Download

Technical explanations

2.2 MB

CAD/CAE-Data

CAD data

2D/3D Models 285-134

URL

Download

CAE data

EPLAN Data Portal 285-134

URL

Download

WSCAD Universe 285-134

URL

Download

ZUKEN Portal 285-134

URL

Download

Environmental Product Compliance

Compliance Search

Environmental Product Compliance 285-134

URL

Download

2-conductor through terminal block; 35 mm²; lateral marker slots; only for DIN 35 x 15 rail; POWER CAGE CLAMP; 35,00 mm²; blue

Installation Notes

Installation

Subject to changes. Please also observe the further product documentation!

WAGO GmbH & Co. KG

Hansastr. 27

32423 Minden

Phone: +49571 887-0 | Fax: +49571 887-169

Email: info.de@wago.com | Web: www.wago.com

Do you have any questions about our products?

We are always happy to take your call at +49 (571) 887-44222.

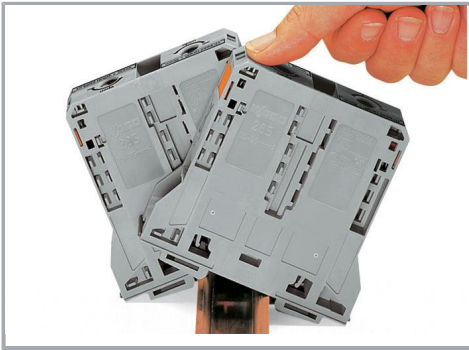

Snapping a terminal block onto DIN-rail (to the left or to the right).

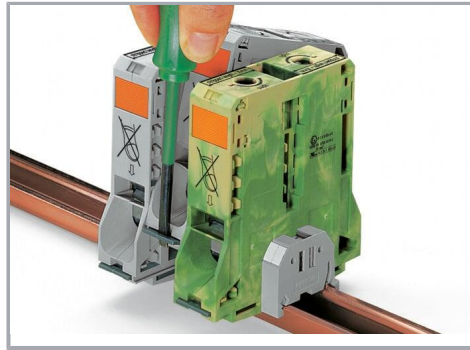

Removing a terminal block from the assembly (to the left or to the right).

Conductor termination

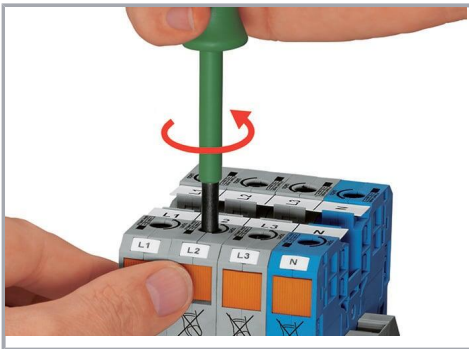

Conductor termination – step 1:

Rotate the operating tool (5.5 mm blade width) counter-clockwise. Next, push in the orange locking tab. The clamp is locked open for hands-free wiring.



Conductor termination – step 2:

Insert a stripped conductor into the clamping unit until it hits the backstop. Hold in this position.

Subject to changes. Please also observe the further product documentation!

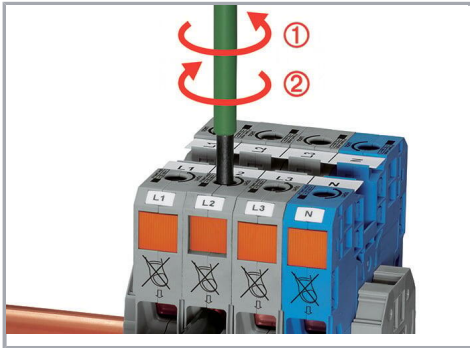

Conductor termination – step 3:

A short counter-clockwise rotation closes the clamp, securing the conductor. When unlocked, allow the operating tool to rotate clockwise to securely terminate the conductor.

Side-entry wiring means that even larger conductors, which have limited flexibility, can be easily connected.

Commoning

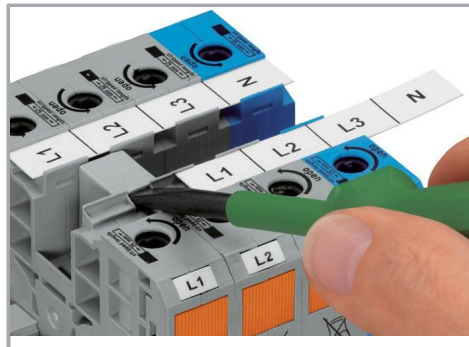
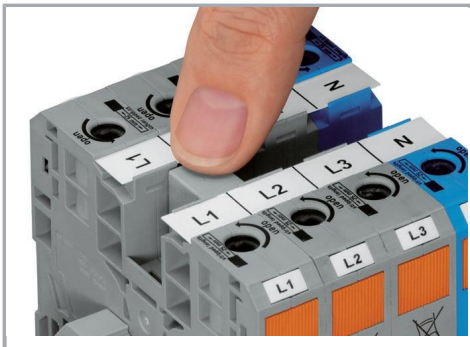

Commoning adjacent terminal blocks using a centrally positioned push-in jumper.

Slide the marking strip laterally to remove the jumper.

Power tap

Subject to changes. Please also observe the further product documentation!

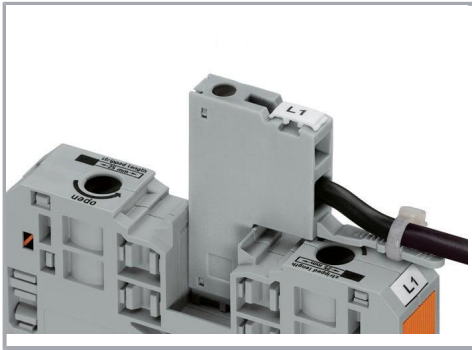

The power tap is inserted into the jumper contact slot. It can be fitted with a strain relief plate.

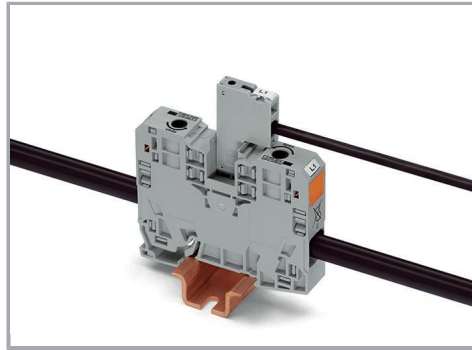

Power tap inserted in a jumper contact slot

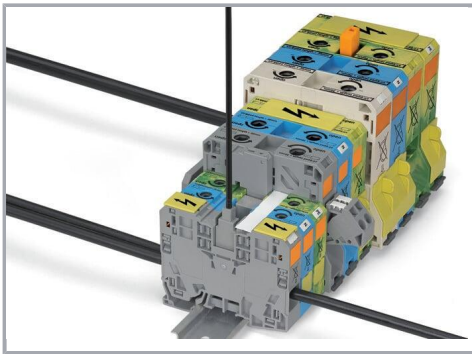

Always push voltage tap (283-407) down into the terminal block until fully inserted!

Testing

Subject to changes. Please also observe the further product documentation!

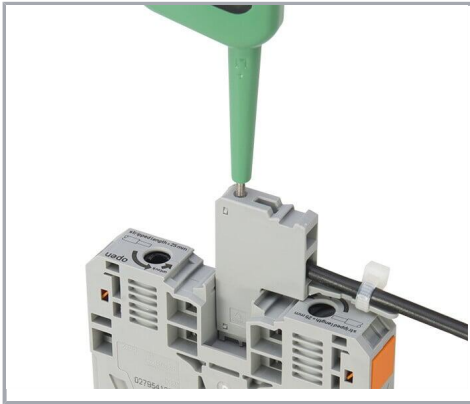

Testing with test plug adapter (283-404).

Testing

Voltage measurements can be performed, e.g., using a 2-pole voltage tester (206-707).

Marking

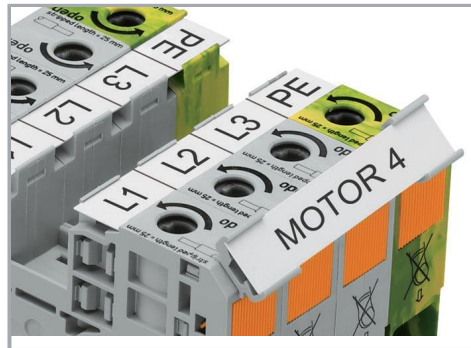
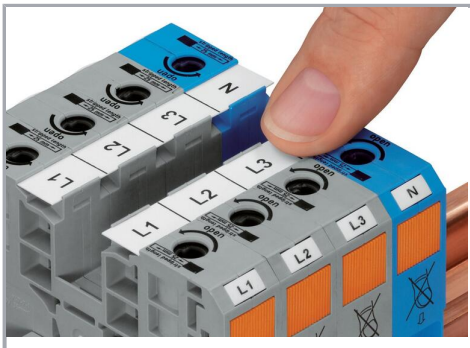

WMB markers or self-adhesive, printable marking strips can be accommodated on 35, 50 and 95 mm² high-current terminal blocks.

Marker carrier (285-442) for marking strips (2009-110) or 2 WMB markers for 285-13x, 285-15x and 285-19x Terminal Blocks

Subject to changes. Please also observe the further product documentation!