

TOSHIBA CMOS Linear Integrated Circuit Silicon Monolithic

TCR5RG series

Ultra high Ripple rejection ratio, 500 mA CMOS Low Dropout Regulator in ultra small package

1. Description

The TCR5RG series are CMOS general-purpose single-output voltage regulators with an on/off control input, featuring low dropout voltage and ultra high Ripple rejection ratio.

These voltage regulators are available in fixed output voltages between 0.9 V and 5.0 V and capable of driving up to 500 mA. They feature Overcurrent protection, Thermal shutdown and Auto-discharge.

The TCR5RG series is offered in the ultra small plastic mold package WCSP4F (0.645 mm x 0.645 mm (Typ.); t 0.33 mm (max)) and has a high ripple rejection ratio of 100 dB (f = 1 kHz, 2.8 V output). As small ceramic input and output capacitors 1.0 μ F can be used with the TCR5RG series, these devices are ideal for portable applications that require high-density board assembly such as cellular phones.

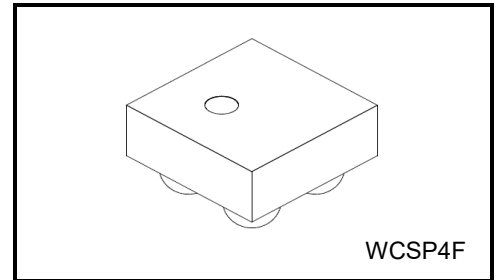

2. Applications

Power IC developed for portable applications

3. Features

- Ultra small package WCSP4F (0.645 mm x 0.645 mm (Typ.); t 0.33 mm (max)).
- High Ripple rejection ratio 100 dB (Typ.) @1 kHz ($V_{OUT} = 2.8$ V)
- High Ripple rejection ratio 93 dB (Typ.) @10 kHz ($V_{OUT} = 2.8$ V)
- High Ripple rejection ratio 67 dB (Typ.) @100 kHz ($V_{OUT} = 2.8$ V)
- High Ripple rejection ratio 59 dB (Typ.) @1 MHz at ($V_{OUT} = 2.8$ V)
- Low output noise voltage ($V_{NO} = 5 \mu V_{rms}$ (Typ.) at $10 \text{ Hz} \leq f \leq 100 \text{ kHz}$)
- Low quiescent current ($I_B = 7 \mu A$ (Typ.) at $I_{OUT} = 0 \text{ mA}$)
- Overcurrent protection
- Thermal shutdown
- Auto-discharge
- Low Dropout voltage
 $V_{DO} = 150 \text{ mV}$ (Typ.), $V_{OUT} = 2.8 \text{ V}$, $I_{OUT} = 500 \text{ mA}$
- Wide range output voltage line up ($V_{OUT} = 0.9$ to 5.0 V)
- Pull down connection between CONTROL and GND
- Ceramic capacitors can be used ($C_{IN} = 1.0 \mu F$, $C_{OUT} = 1.0 \mu F$)

Start of commercial production
2020-12

4. Absolute Maximum Ratings (Ta = 25°C)

Characteristics	Symbol	Rating	Unit
Input voltage	V _{IN}	-0.3 to 6.0	V
Control voltage	V _{CT}	-0.3 to V _{IN} + 0.3 ≤ 6.0	V
Output voltage	V _{OUT}	-0.3 to V _{IN} + 0.3 ≤ 6.0	V
Output current	I _{OUT}	500	mA
Power dissipation	P _D	800 (Note1)	mW
Junction temperature	T _j	150	°C
Storage temperature range	T _{stg}	-55 to 150	°C

Note: Using continuously under heavy loads (e.g. the application of high temperature/current/voltage and the significant change in temperature, etc.) may cause this product to decrease in the reliability significantly even if the operating conditions (i.e. operating temperature/current/voltage, etc.) are within the absolute maximum ratings and the operating ranges.

Please design the appropriate reliability upon reviewing the Toshiba Semiconductor Reliability Handbook (“Handling Precautions”/“Derating Concept and Methods”) and individual reliability data (i.e. reliability test report and estimated failure rate, etc).

Note1: Rating at mounting on a board

Glass epoxy(FR4) board dimension: 40mm x 40mm x 1.6mm, both sides of board.

Metal pattern ratio: a surface approximately 50%, the reverse side approximately 50%

5. Pin Assignment (top view)

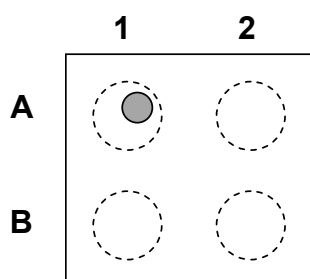

	1	2
A	V _{IN}	V _{OUT}
B	CONTROL	GND

6. Operating Ranges

Characteristics	Symbol	Rating	Unit
Input voltage	V _{IN}	1.8 to 5.5 (Note 2)	V
Control voltage	V _{CT}	0 to V _{IN}	V
Output voltage	V _{OUT}	0.9 to 5.0	V
Output current	I _{OUT}	DC 500	mA
Operating Temperature	T _{opr}	-40 to 85	°C
Output Capacitance	C _{OUT}	≥ 1.0 μF	—
Input Capacitance	C _{IN}	≥ 1.0 μF	—

Note 2: Please refer to Dropout Voltage table (Page 6) and use it within Absolute Maximum Ratings Junction temperature and Operating Temperature Ranges.

7. List of Products Number, Output voltage and Marking

Product No.	Output voltage(V)	Marking
TCR5RG09A	0.9	<u>A</u>
TCR5RG095A	0.95	<u>B</u>
TCR5RG10A	1.0	<u>C</u>
TCR5RG105A	1.05	<u>D</u>
TCR5RG11A	1.1	<u>E</u>
TCR5RG115A	1.15	<u>F</u>
TCR5RG12A	1.2	N
TCR5RG1225A	1.225	A
TCR5RG125A	1.25	B
TCR5RG13A	1.3	<u>H</u>
TCR5RG135A	1.35	<u>J</u>
TCR5RG14A	1.4	C
TCR5RG15A	1.5	<u>K</u>
TCR5RG16A	1.6	D
TCR5RG17A	1.7	<u>L</u>
TCR5RG175A	1.75	<u>M</u>
TCR5RG18A	1.8	<u>N</u>
TCR5RG1825A	1.825	P
TCR5RG185A	1.85	<u>P</u>
TCR5RG19A	1.9	<u>R</u>
TCR5RG20A	2.0	<u>S</u>
TCR5RG25A	2.5	<u>T</u>
TCR5RG255A	2.55	L
TCR5RG27A	2.7	<u>V</u>
TCR5RG28A	2.8	<u>W</u>
TCR5RG285A	2.85	<u>X</u>
TCR5RG29A	2.9	<u>Y</u>
TCR5RG2925A	2.925	M
TCR5RG295A	2.95	R
TCR5RG30A	3.0	<u>0</u>
TCR5RG31A	3.1	<u>1</u>
TCR5RG32A	3.2	<u>2</u>
TCR5RG33A	3.3	<u>3</u>
TCR5RG34A	3.4	E
TCR5RG35A	3.5	<u>4</u>
TCR5RG36A	3.6	<u>5</u>
TCR5RG40A	4.0	F
TCR5RG41A	4.1	S
TCR5RG42A	4.2	<u>6</u>
TCR5RG43A	4.3	H
TCR5RG45A	4.5	<u>7</u>
TCR5RG46A	4.6	<u>8</u>
TCR5RG47A	4.7	J
TCR5RG48A	4.8	K
TCR5RG50A	5.0	<u>9</u>

Top Marking (top view)

Example: TCR5RG28A (2.8 V output)

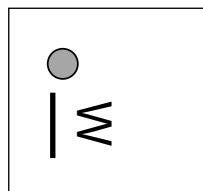

Block Diagram

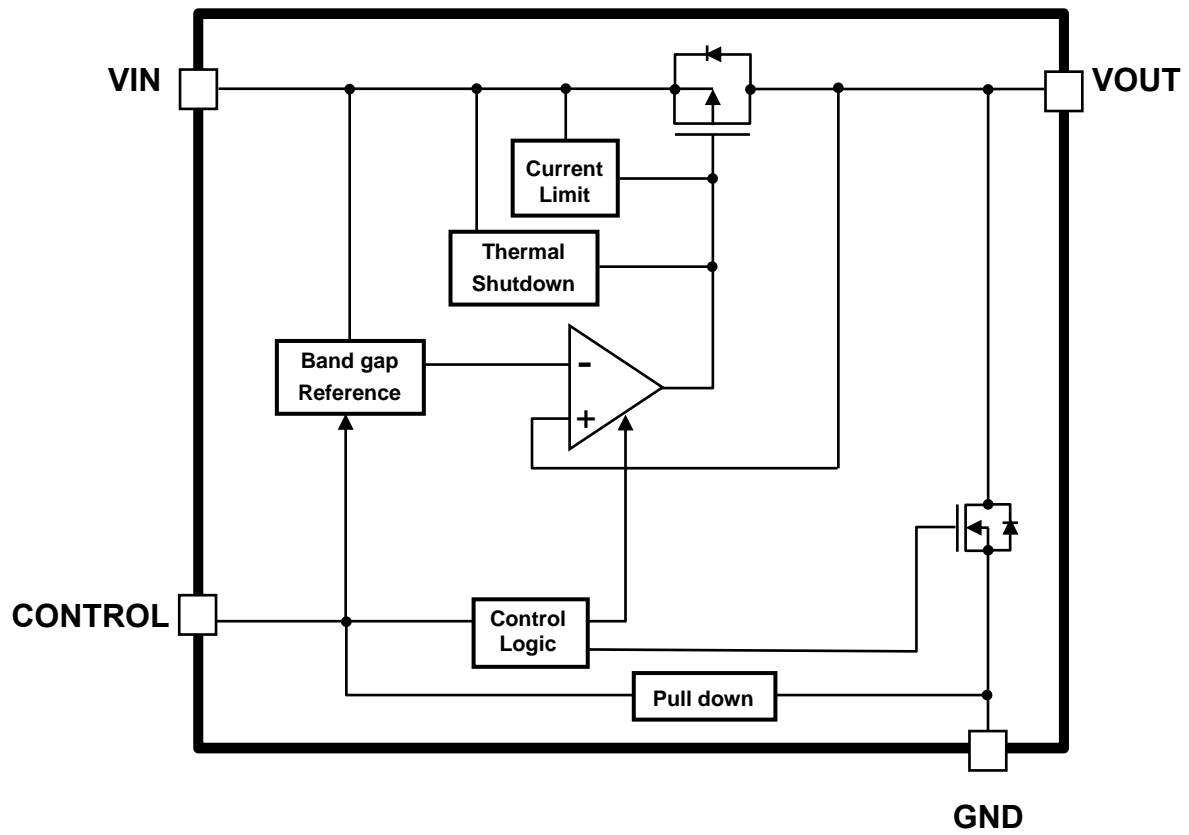

8. Electrical Characteristics

(Unless otherwise specified, $V_{IN} = 2.0\text{ V}$ or $V_{OUT} + 0.5\text{ V}$ (whichever is greater), $C_{IN} = C_{OUT} = 1.0\text{ }\mu\text{F}$)

Characteristics	Symbol	Test Condition	$T_j = 25^\circ\text{C}$			$T_j = -40\text{ to }85^\circ\text{C}$ (Note 6)		Unit	
			Min	Typ.	Max	Min	Max		
Output voltage accuracy	V_{OUT}	$I_{OUT} = 1\text{ mA to }500\text{ mA}$ (Note 3)	$V_{OUT} < 1.8\text{ V}$	—	—	—	-36	+36	mV
			$1.8\text{ V} \leq V_{OUT} \leq 2.8\text{ V}$	—	—	—	-1.5	+1.5	%
			$2.8\text{ V} < V_{OUT}$	—	—	—	-1.8	+1.8	
Line regulation	Reg·line	$I_{OUT} = 1\text{ mA}$ (Note 3)	—	0.5	—	—	—	mV	
Load regulation	Reg·load	$1\text{ mA} \leq I_{OUT} \leq 500\text{ mA}$	—	3	—	—	—	mV	
Quiescent current	$I_{B(ON)}$	$I_{OUT} = 0\text{ mA}$ (Note 5)	—	7	—	—	13	μA	
Stand-by current	$I_{B(OFF)}$	$V_{CT} = 0\text{ V}$	—	0.08	—	—	0.2	μA	
Control pull down current	I_{CT}	—	—	0.08	—	—	0.2	μA	
Dropout voltage (Note 7)	V_{DO}	$I_{OUT} = 500\text{ mA}$	$V_{OUT} = 1.8\text{ V}$	—	235	—	—	290	mV
			$V_{OUT} = 2.8\text{ V}$	—	150	—	—	210	mV
Output noise voltage	V_{NO}	$I_{OUT} = 10\text{ mA}$ $10\text{ Hz} \leq f \leq 100\text{ kHz}$ (Note 4)	—	5	—	—	15	μV_{rms}	
		$I_{OUT} = 250\text{ mA}$ $10\text{ Hz} \leq f \leq 100\text{ kHz}$ (Note 4)	—	5	—	—	15		
Ripple rejection ratio	R.R.	$I_{OUT} = 10\text{ mA}$, $V_{IN} = V_{OUT} + 1\text{ V}$ $V_{Ripple} = 200\text{ mV}_{p-p}$, (Note 4)	$f = 1\text{ kHz}$	—	100	—	—	—	dB
			$f = 10\text{ kHz}$	—	93	—	—	—	dB
			$f = 100\text{ kHz}$	—	67	—	—	—	dB
			$f = 1\text{ MHz}$	—	59	—	—	—	dB
Load transient response	ΔV_{OUT}	$I_{OUT} = 1\text{ mA to }500\text{ mA}$	—	-40	—	—	—	mV	
		$I_{OUT} = 500\text{ mA to }1\text{ mA}$	—	+40	—	—	—	mV	
Output voltage slew rate	V_{OUTSR}	—	—	30	—	—	—	$\text{mV}/\mu\text{s}$	
Output current limit	I_{CL}	—	—	700	—	600	850	mA	
Thermal shutdown threshold	T_{SDH}	T_j rising	—	160	—	—	—	$^\circ\text{C}$	
	T_{SDL}	T_j falling	—	140	—	—	—	$^\circ\text{C}$	
Control voltage (ON)	$V_{CT(ON)}$	—	—	—	—	0.9	V_{IN}	V	
Control voltage (OFF)	$V_{CT(OFF)}$	—	—	—	—	0	0.5	V	
Discharge on resistance	R_{SD}	(Note4)	—	30	—	—	—	Ω	

Note 3: stable state with fixed I_{OUT} condition
 $((V_{OUT} + 0.5\text{ V}) \text{ or } 2\text{ V whichever is greater}) \leq V_{IN} \leq 5.5\text{ V}$

Note 4: $V_{OUT} = 2.8\text{ V}$

Note 5: except Control pull down current (I_{CT})

Note 6: This parameter is warranted by design.

Note 7: $V_{DO} = V_{IN1} - (V_{OUT1} \times 0.97)$

V_{OUT1} is the nominal output voltage.

V_{IN1} is the input voltage at which the output voltage becomes 97% of V_{OUT1} after gradually decreasing the input voltage.

Dropout voltage table ($C_{IN} = 1.0 \mu F$, $C_{OUT} = 1.0 \mu F$)

Output voltages	$I_{OUT} = 500 \text{ mA}$			Unit
	Min	Typ.	Max (Note 8)	
$0.9 \text{ V} \leq V_{OUT} \leq 1.35 \text{ V}$	—	(Note 9)	(Note 9)	mV
1.4 V	—	320 (Note 9)	460 (Note 9)	mV
1.5 V	—	310	400	mV
1.6 V	—	260	350	mV
1.7 V	—	250	320	mV
1.75 V	—	240	300	mV
1.8 V	—	235	290	mV
1.825 V	—	235	285	mV
1.85 V	—	230	280	mV
1.9 V	—	225	270	mV
2.0 V	—	215	255	mV
2.5 V, 2.55 V	—	170	230	mV
2.7 V	—	160	215	mV
2.8 V, 2.85 V	—	150	210	mV
2.9 V, 2.925 V, 2.95 V	—	150	205	mV
3.0 V, 3.1 V	—	145	205	mV
3.2 V	—	140	195	mV
3.3 V, 3.4 V	—	135	190	mV
3.5 V, 3.6 V	—	130	185	mV
4.0 V, 4.1 V	—	115	175	mV
4.2 V, 4.3 V	—	115	170	mV
4.5 V	—	115	165	mV
4.6 V, 4.7 V, 4.8 V	—	110	165	mV
5.0 V	—	108	160	mV

Note 8: $T_j = -40$ to 85°C . This parameter is guaranteed by design

Note 9: Operating Voltage of V_{IN} should be over 1.8 V.

9. Application Note

9.1. Recommended Application Circuit

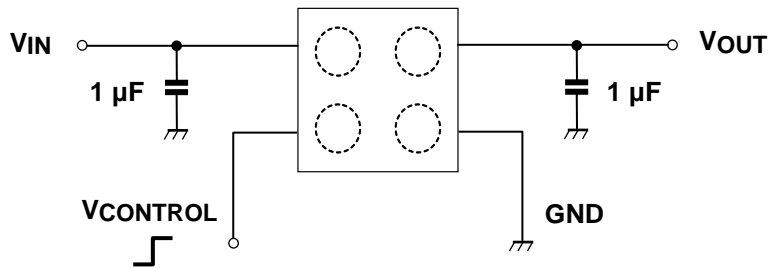

The figure above shows the recommended configuration for using a Low Dropout regulator. Insert a capacitor at VOUT and VIN pins for stable input/output operation. (Ceramic capacitors can be used.)

9.2. Power Dissipation

Board-mounted power dissipation ratings are available in the Absolute Maximum Ratings table. Power dissipation is measured on the board condition shown below.

[The Board Condition]

Board material: Glass epoxy (FR4)

Board dimension: 40 mm x 40 mm (both sides of board), t = 1.6 mm

Metal pattern ratio: a surface approximately 50%, the reverse side approximately 50%

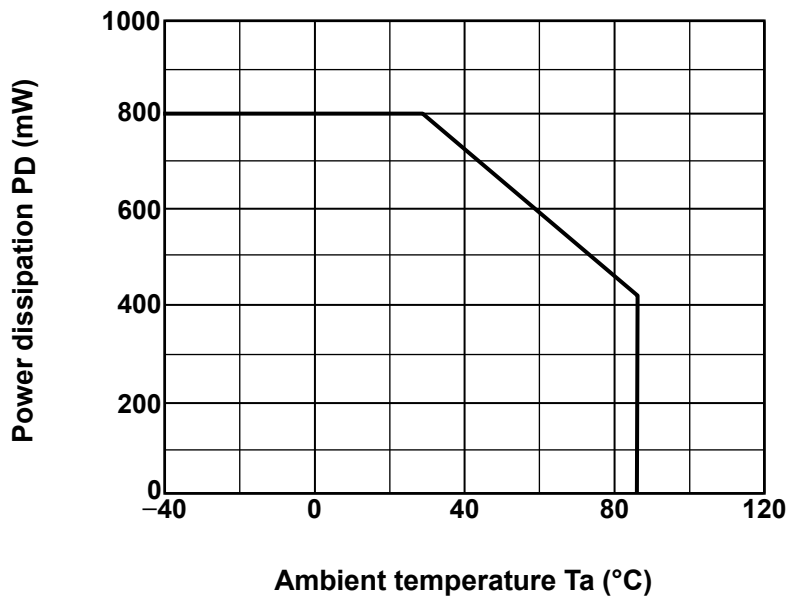

9.3. Attention in Use

- Output Capacitors

Toshiba recommends using ceramic capacitors for these devices. However, because of the type of the capacitors, there might be greatly affected by thermal features and DC bias depending. Please secure an effective capacitance of 0.6 μF or more by considering application condition for selecting capacitors.

- Bias current characteristics

TCR5RG series has Bias current; $I_{B(ON)}$ characteristic that controlled depending on I_{OUT} .

When the output current required is very low, TCR5RG series operates with low $I_{B(ON)}$. In this state, Ripple rejection ratio characteristic and load transient response characteristic are inferior than normal characteristics.

Regarding output current that switches $I_{B(ON)}$ state, TCR5RG series has hysteresis to control. When output current is increased, good Ripple rejection ratio characteristics and good load transient response characteristics are provided with $I_{B(ON)}$ becoming high. In the case of decreasing the I_{OUT} , TCR5RG series keeps good characteristics until the $I_{B(ON)}$ switches to a low state.

- Mounting

The long distance between IC and output capacitor might affect phase assurance by impedance in wire and inductor. For stable power supply, output capacitor need to mount near IC as much as possible. Also V_{IN} and GND pattern need to be large and make the wire impedance small as possible.

- Permissible Loss

Please have enough design patterns for expected maximum permissible loss. And under consideration of surrounding temperature, input voltage, output current etc., we recommend proper dissipation ratings for maximum permissible loss; in general maximum dissipation rating is 70 to 80%.

- Over current Protection and Thermal shutdown function

Over current protection and Thermal shutdown function are designed in these products, but these are not designed to constantly ensure the suppression of the device within operation limits. Depending on the condition during actual usage, it could affect the electrical characteristic specification and reliability. Also note that if output pins and GND pins are not completely shorted out, these products might be break down. When using these products, please read through and understand the concept of dissipation for absolute maximum ratings from the above mention or our 'Semiconductor Reliability Handbook'. Then use these products under absolute maximum ratings in any condition. Furthermore, Toshiba recommends inserting failsafe system into the design.

- High ripple rejection ratio and low output noise voltage characteristics

TCR5RG series has low-pass filter which contributes high ripple rejection ratio and low output noise voltage.

This low-pass filter turns on after V_{OUT} becomes near the nominal V_{OUT} .

Therefore, before and when the low-pass filter is turned on, please be careful about the increase and decrease of V_{OUT} such as CONTROL voltage from low to high and load transient response.

It affects significantly especially when the voltage difference between V_{IN} and V_{OUT} is small.

10. Representative Typical Characteristics

10.1. Output Voltage vs. Output Current

($V_{IN} = 2.0\text{ V}$ or $V_{OUT} + 0.5\text{ V}$ (whichever is greater))

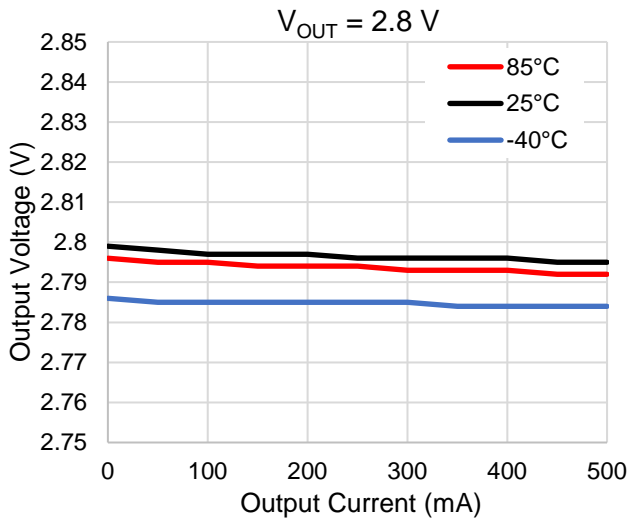
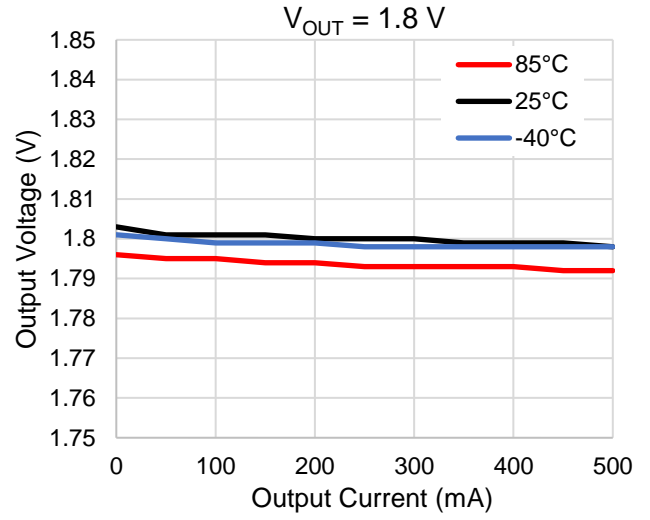
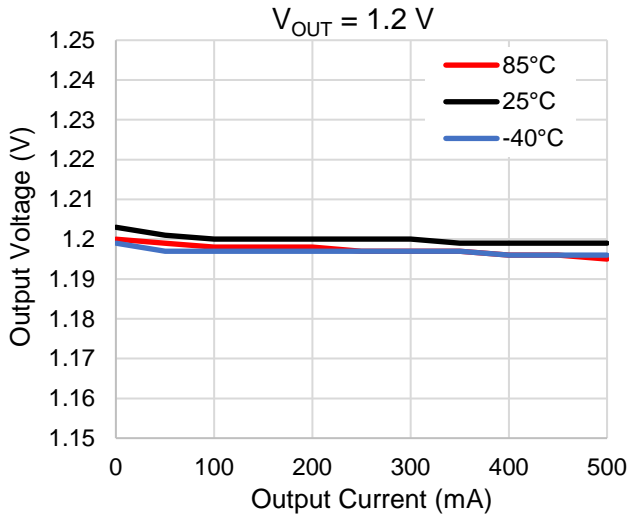

10.2. Dropout Voltage vs. Output Current

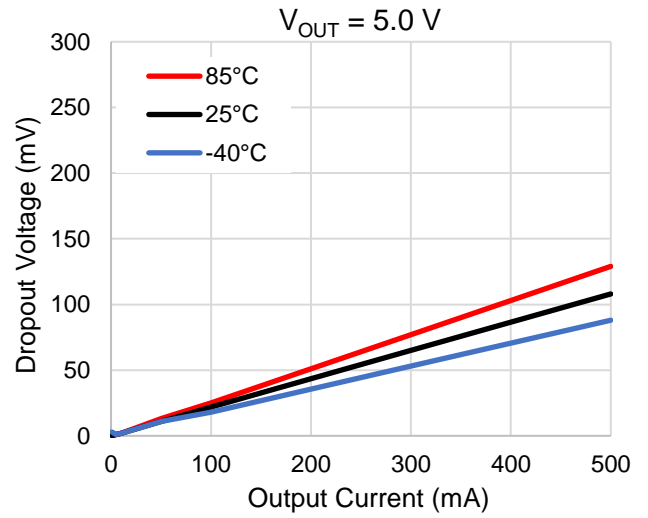
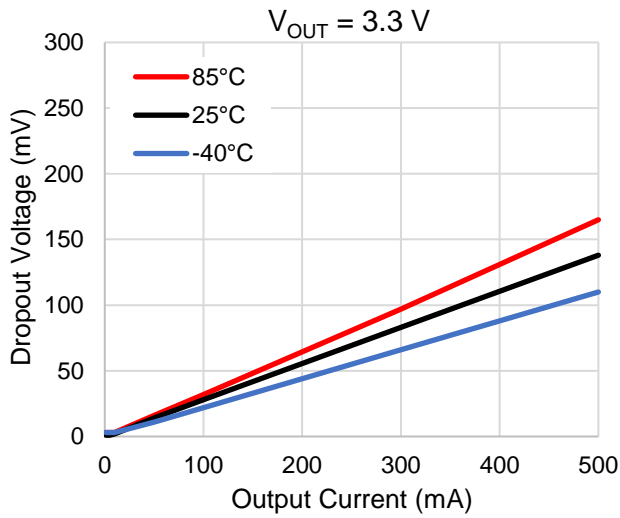
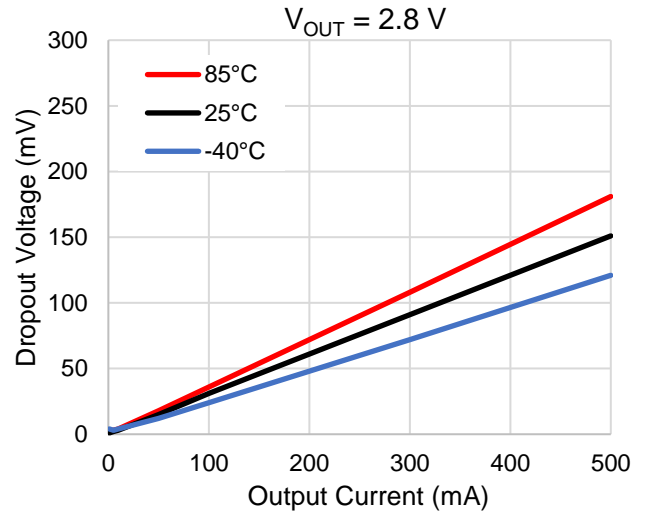
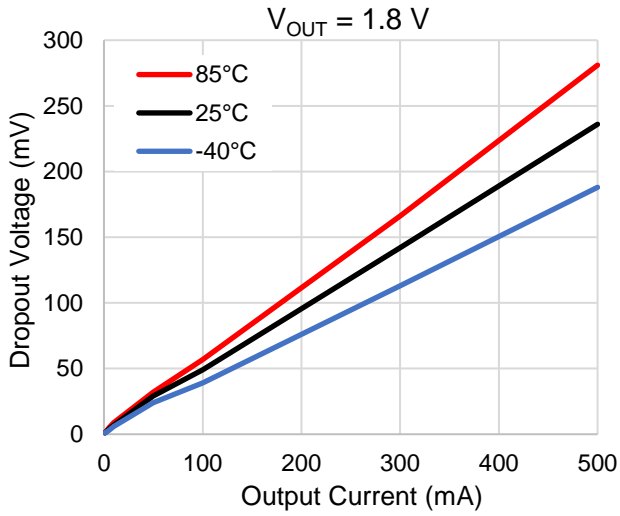

10.3. Quiescent Current vs. Input Voltage ($I_{OUT} = 0$ mA)

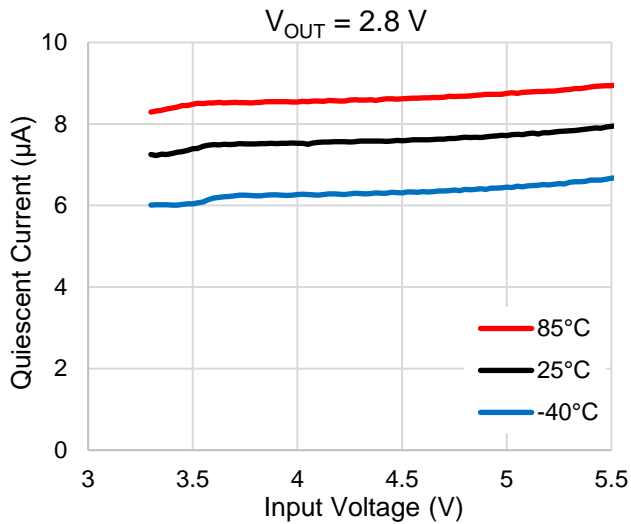
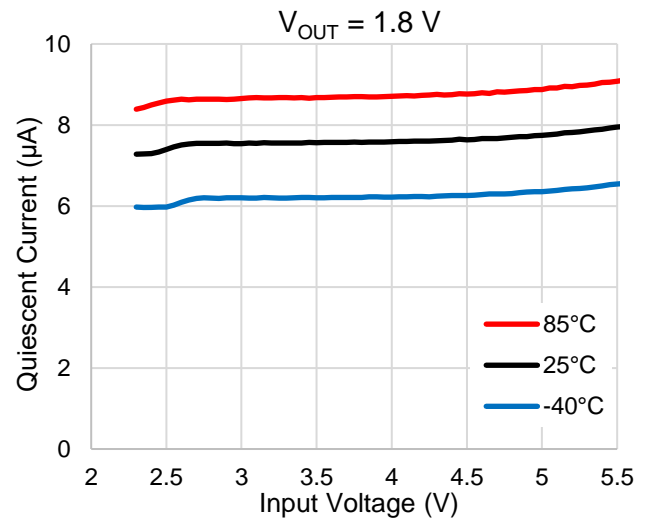
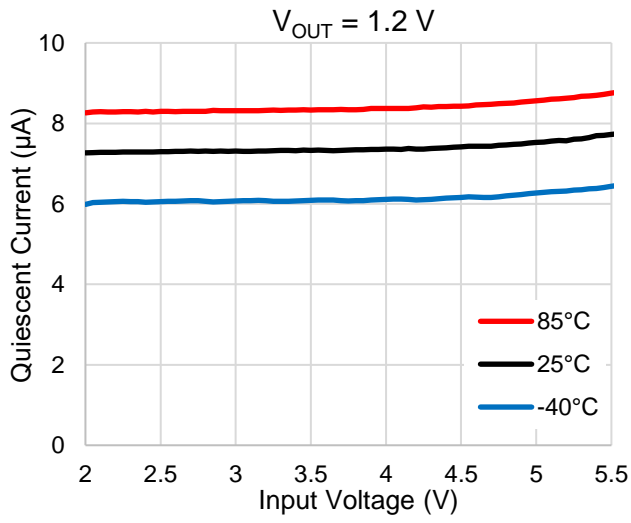

10.4. Quiescent Current vs. Output Current

($V_{IN} = 2.0\text{ V}$ or $V_{OUT} + 0.5\text{ V}$ (whichever is greater), $I_{OUT} = 0\text{ A} \leftrightarrow 300\text{ }\mu\text{A}$, $T_a = 25^\circ\text{C}$)

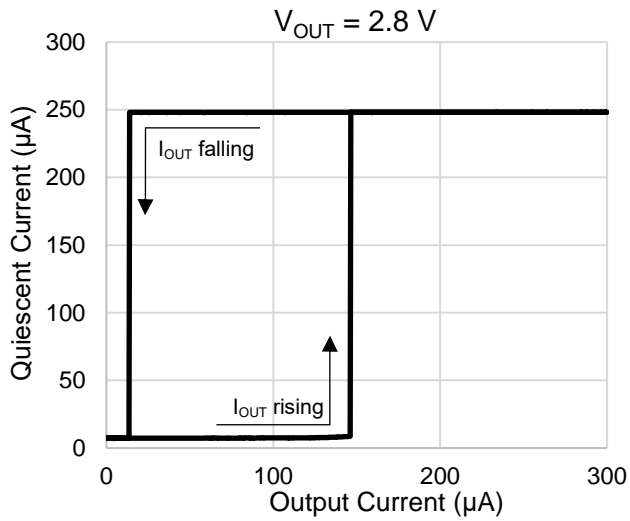
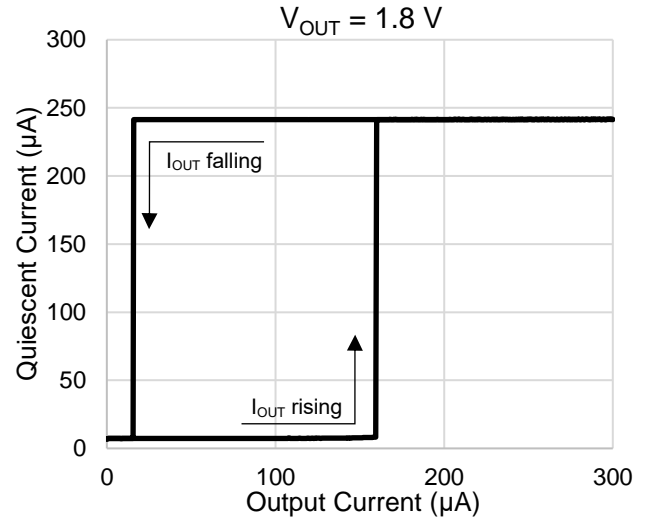
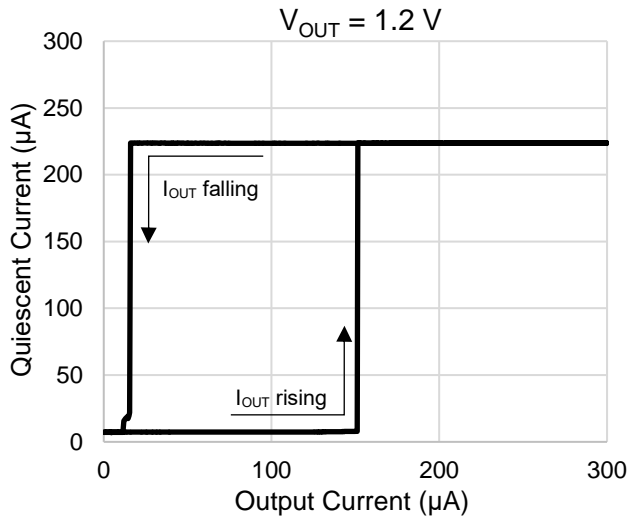

10.5. Output Current Limit

($V_{IN} = 2.0\text{ V}$ or $V_{OUT} + 0.5\text{ V}$ (whichever is greater), $T_a = 25^\circ\text{C}$)

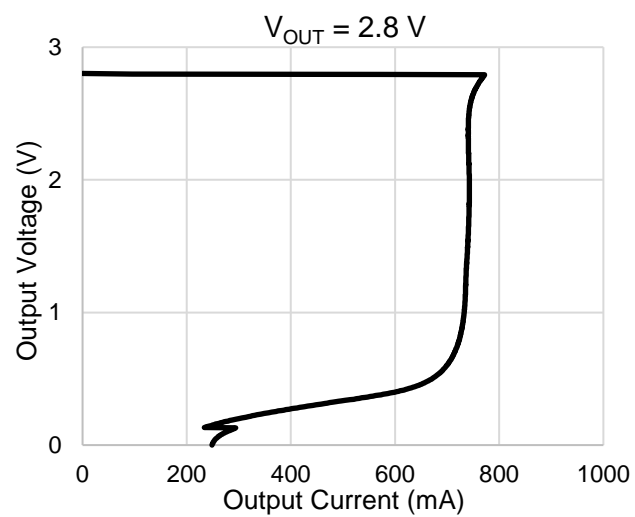
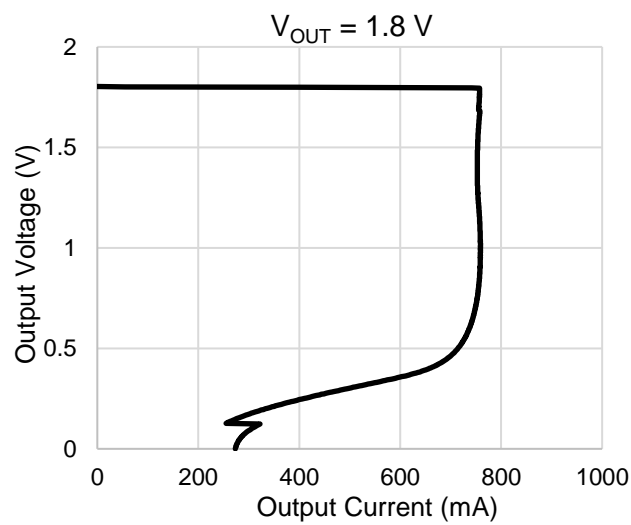
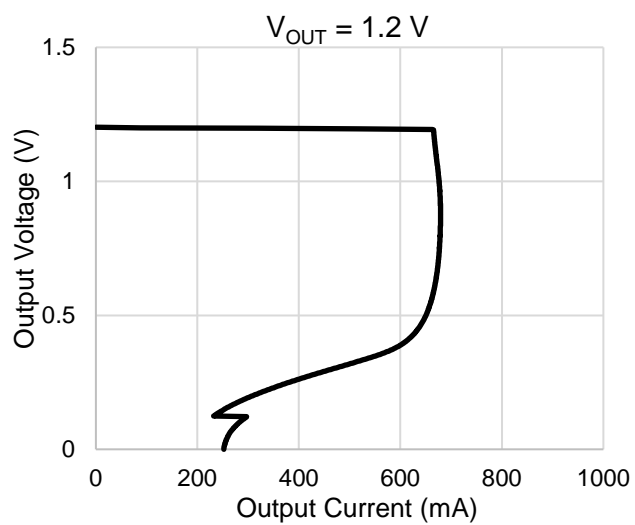

10.6. Ripple rejection Ratio vs. Frequency

(C_{IN} = none, C_{OUT} = 1.0 μ F, V_{IN} = 2.0 V or V_{OUT} + 0.5 V (whichever is greater), V_{IN} Ripple = 200 mV_{p-p}, I_{OUT} = 10 mA, T_a = 25°C)

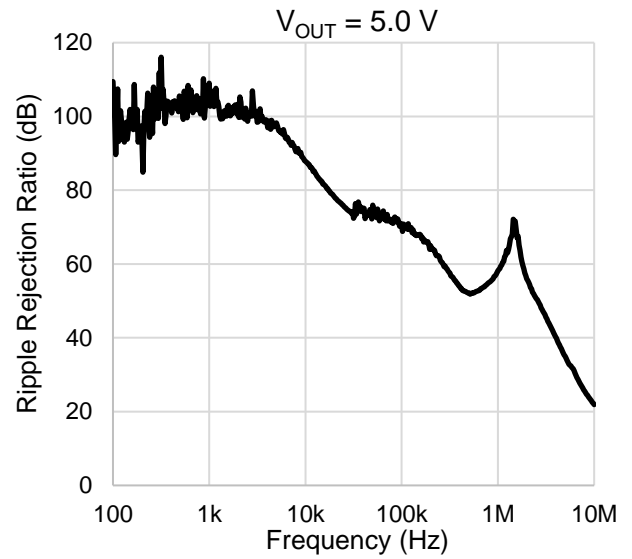
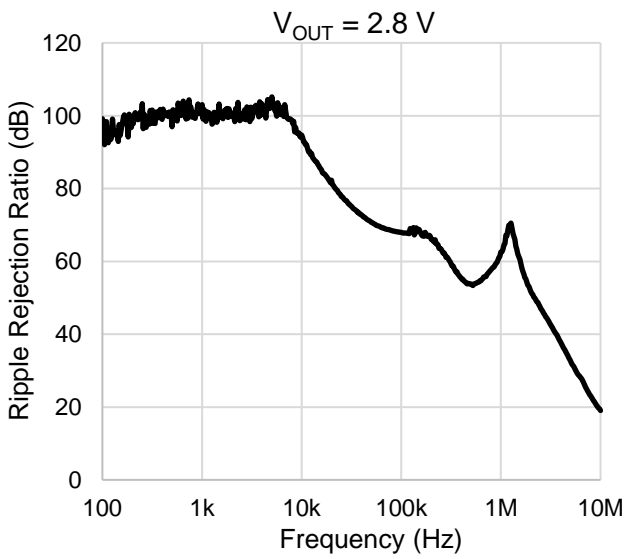
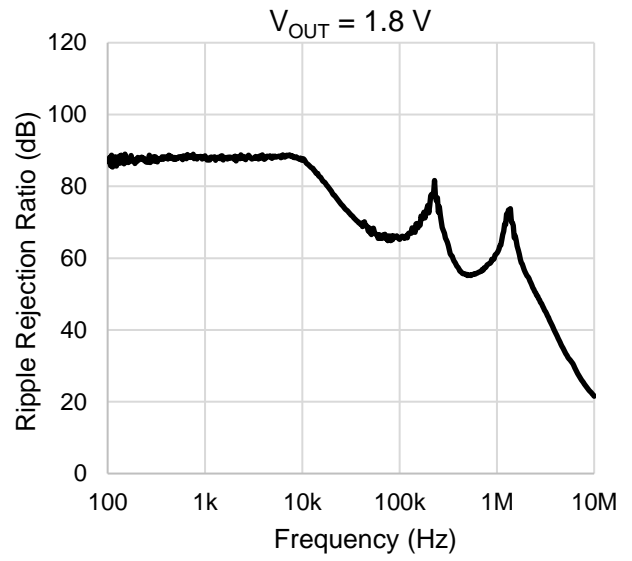
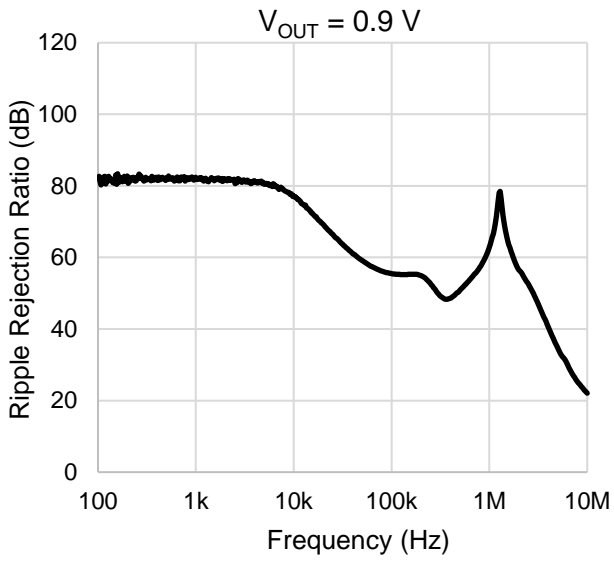

10.7. Output noise Voltage

($C_{IN} = 1.0 \mu F$, $C_{OUT} = 1.0 \mu F$, $V_{IN} = 2.0 V$ or $V_{OUT} + 0.5 V$ (whichever is greater), $I_{OUT} = 10 mA$, $T_a = 25^\circ C$)

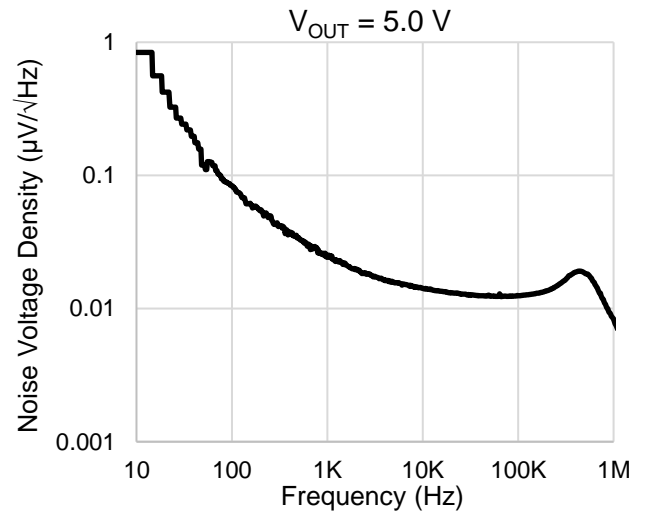
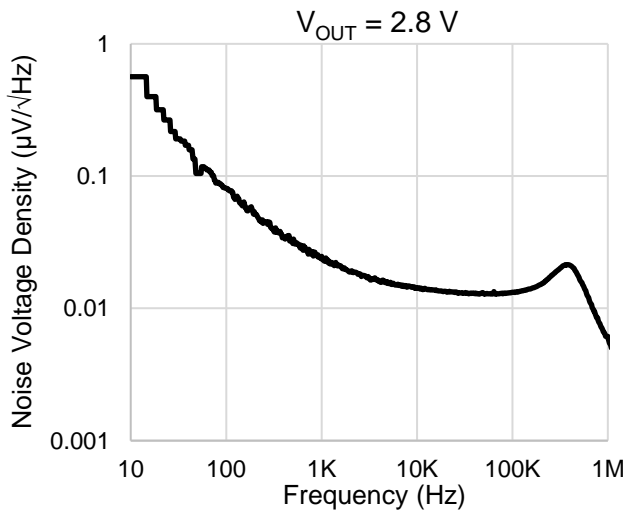
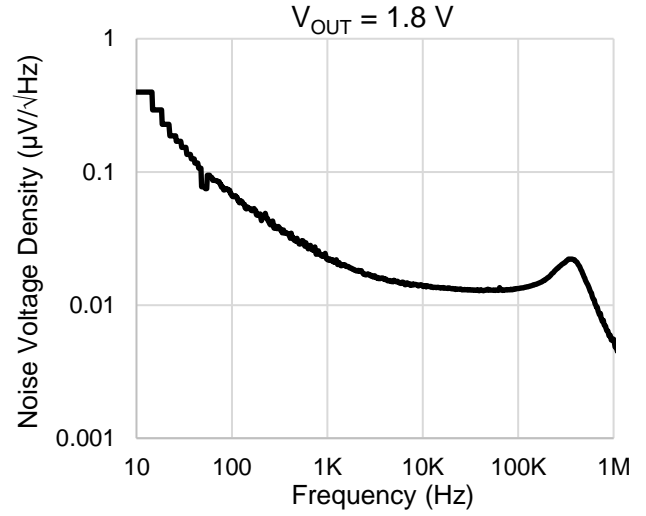
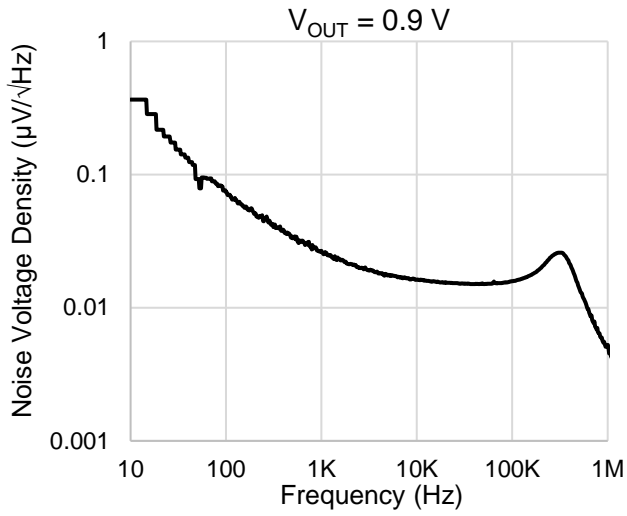

10.8. t_{ON} / t_{OFF} Response

($C_{IN} = 1.0 \mu F$, $V_{IN} = 2.0 V$ or $V_{OUT} + 0.5 V$ (whichever is greater), $V_{CONTROL} = 0 V \leftrightarrow 1.0 V$, $T_a = 25^\circ C$)

- $C_{OUT} = 1.0 \mu F$, $I_{OUT} = 10 mA$

$V_{OUT} = 1.2 V$

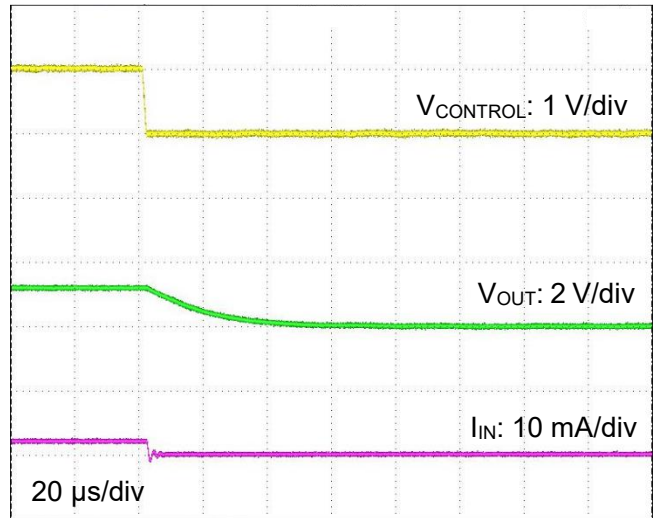
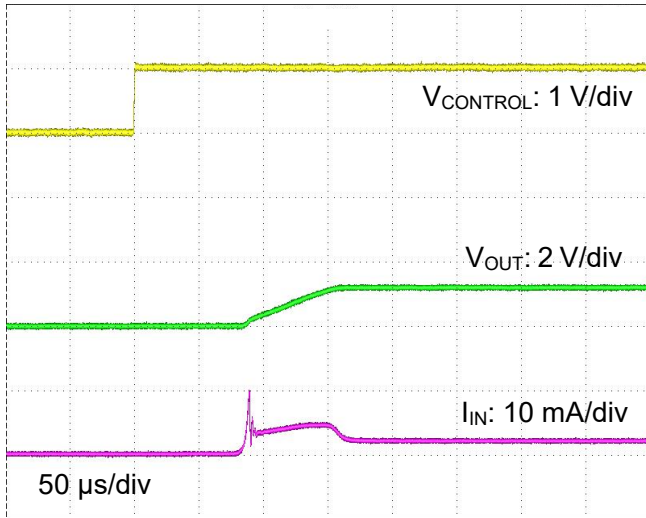

$V_{OUT} = 2.8 V$

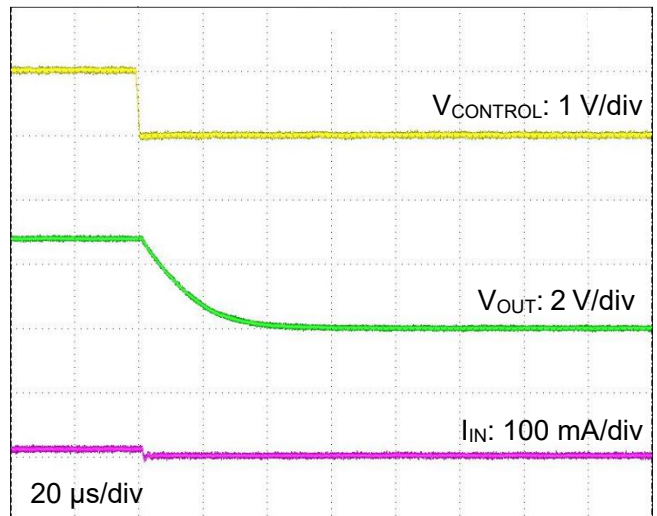
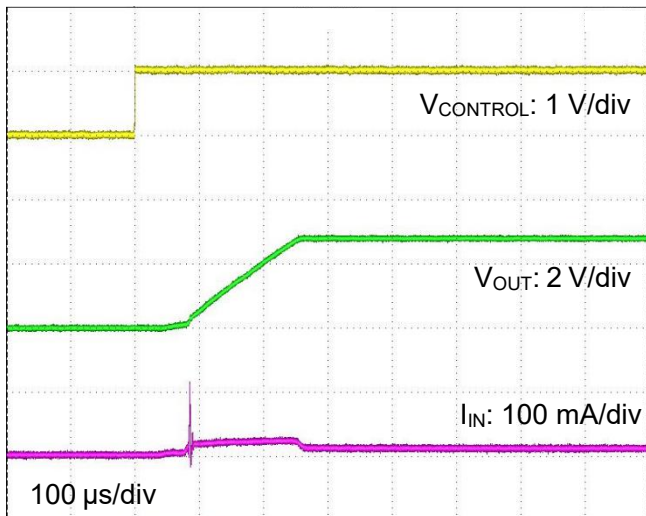

- $C_{OUT} = 4.7 \mu\text{F}$, $I_{OUT} = 10 \text{ mA}$

$V_{OUT} = 1.2 \text{ V}$

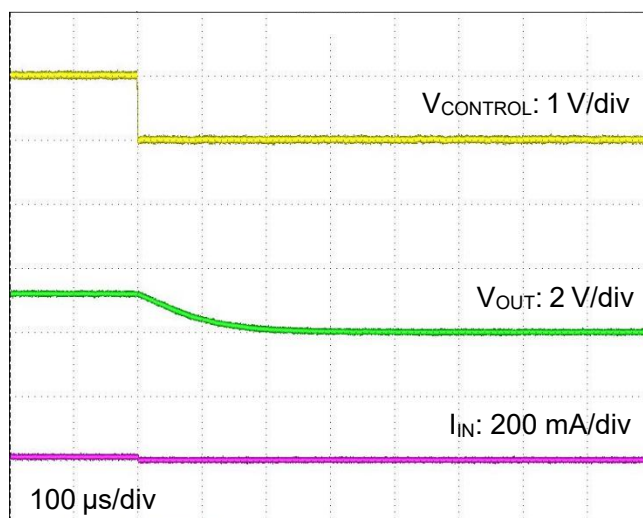
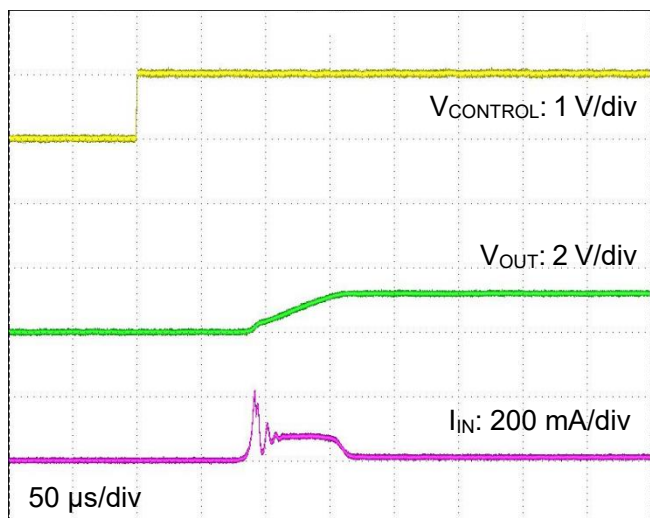

$V_{OUT} = 2.8 \text{ V}$

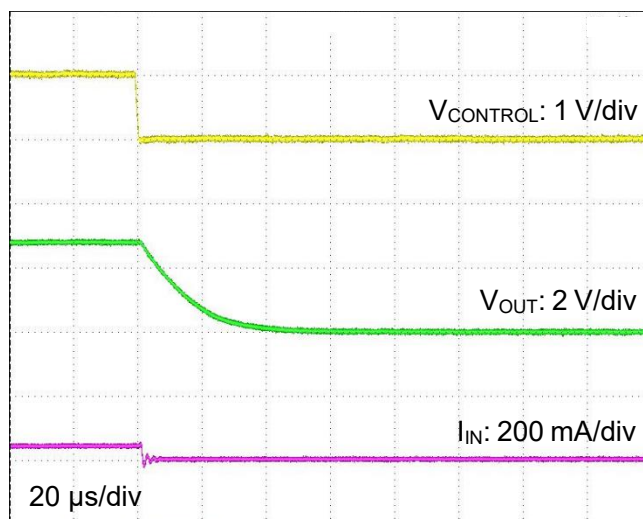
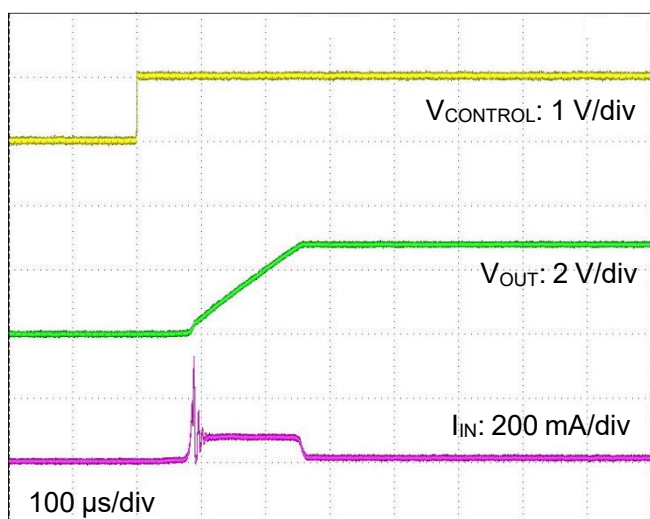

- $C_{OUT} = 1.0 \mu\text{F}$, $I_{OUT} = 500 \text{ mA}$

$V_{OUT} = 1.2 \text{ V}$

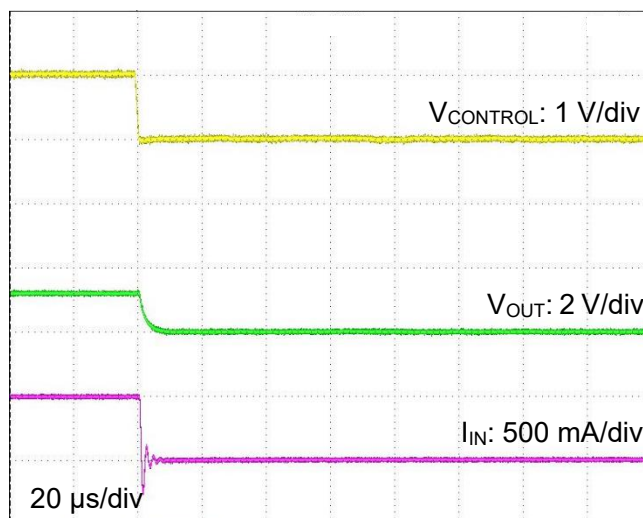
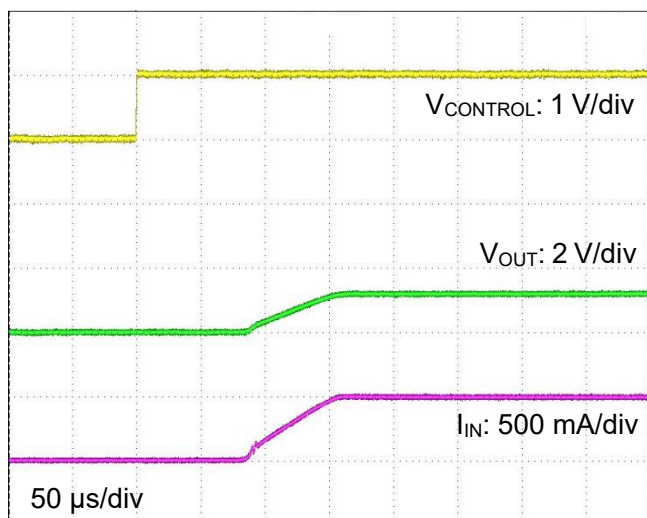

$V_{OUT} = 2.8 \text{ V}$

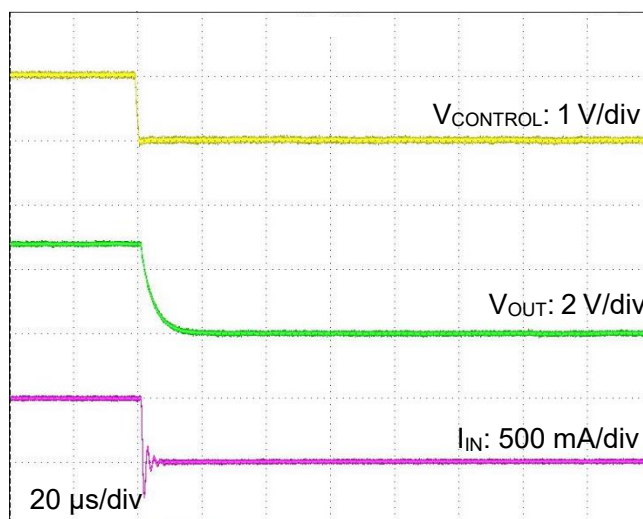
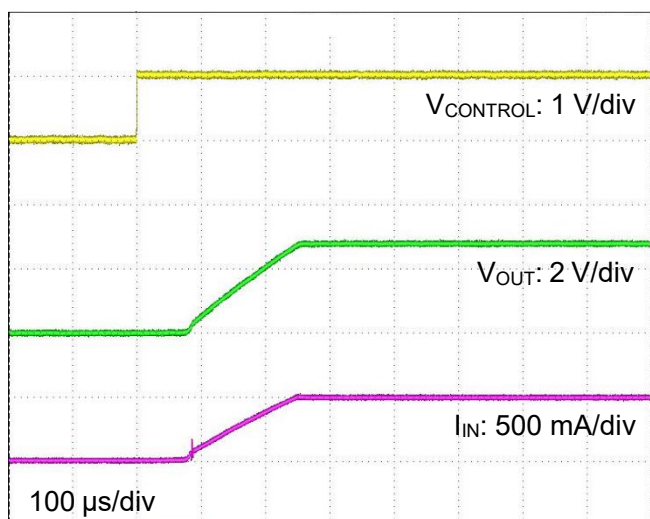

- $C_{OUT} = 4.7 \mu\text{F}$, $I_{OUT} = 500 \text{ mA}$

$V_{OUT} = 1.2 \text{ V}$

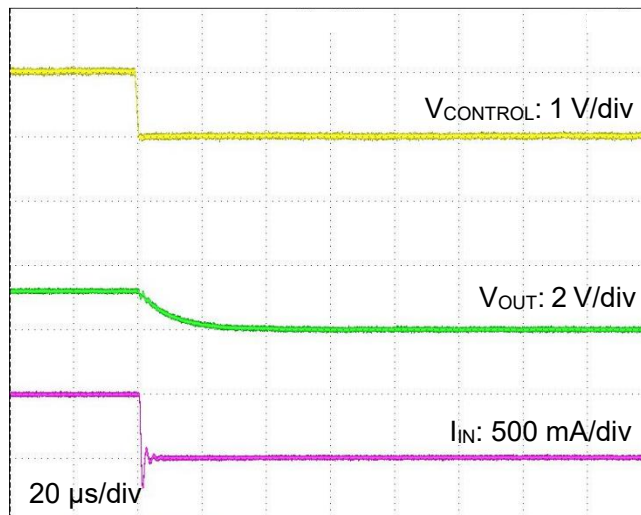
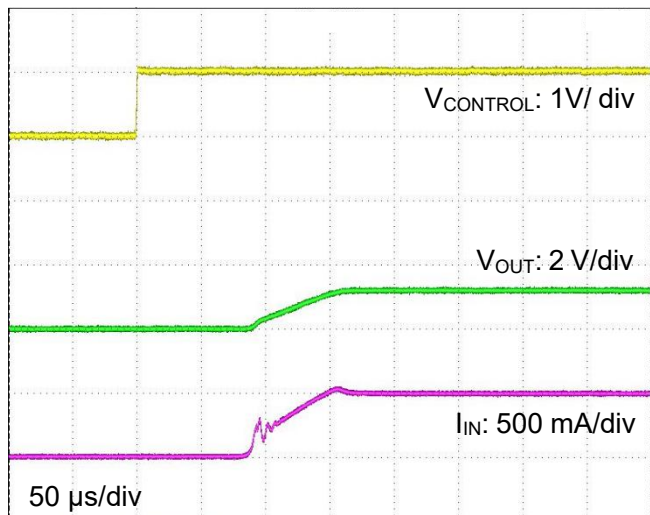

$V_{OUT} = 2.8 \text{ V}$

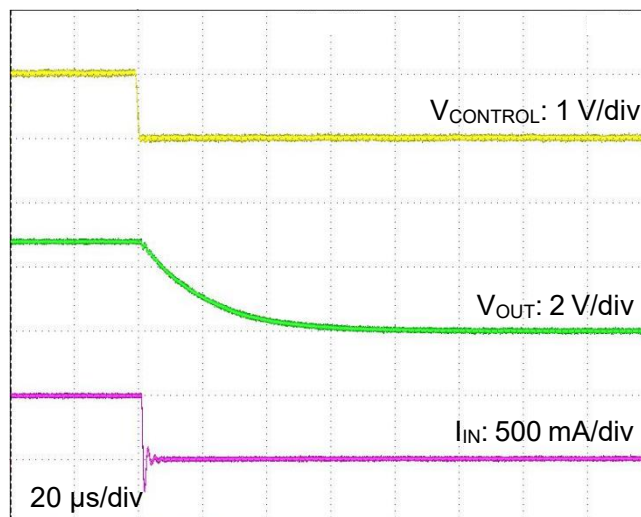
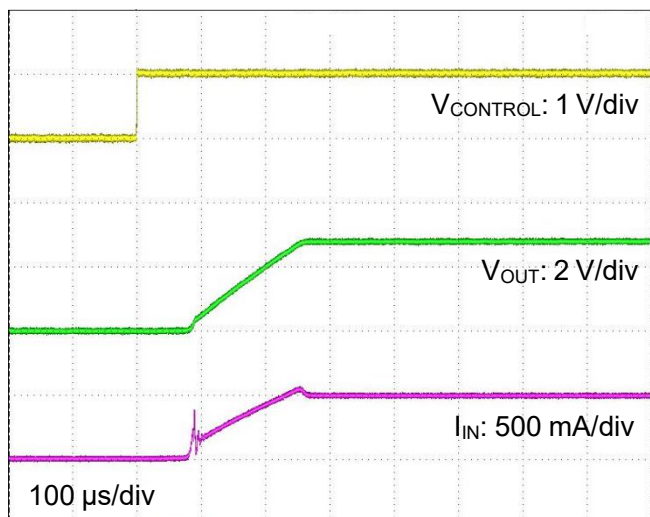

10.9. Load Transient Response

($C_{IN} = 1.0 \mu F$, $C_{OUT} = 1.0 \mu F$, $V_{IN} = 3.3 V$, $V_{OUT} = 2.8 V$, $t_r = 1.0 \mu s$, $t_f = 1.0 \mu s$, $T_a = 25^\circ C$)

$I_{OUT} = 1 mA \leftrightarrow 500 mA$

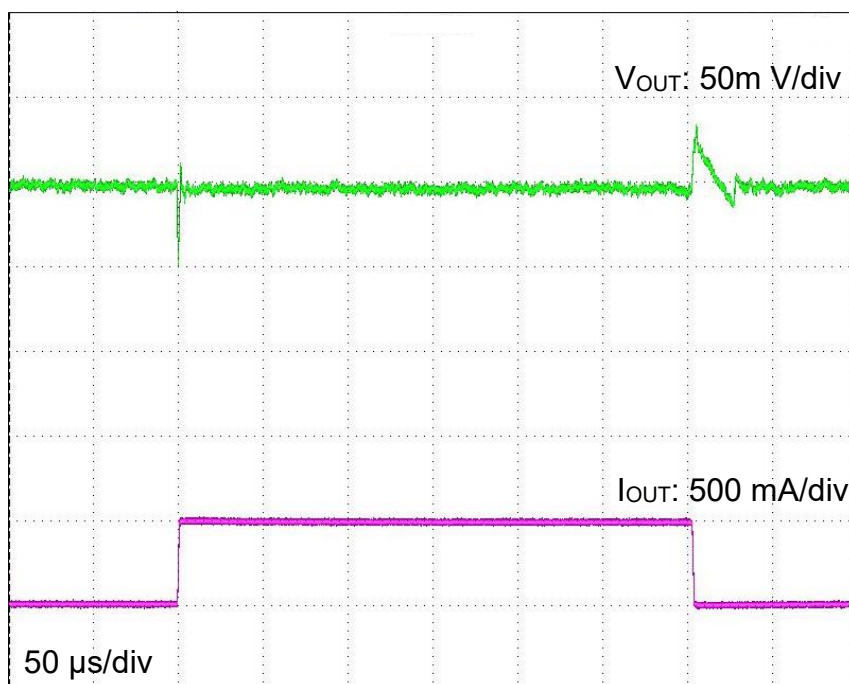

$I_{OUT} = 0 mA \leftrightarrow 100 mA$

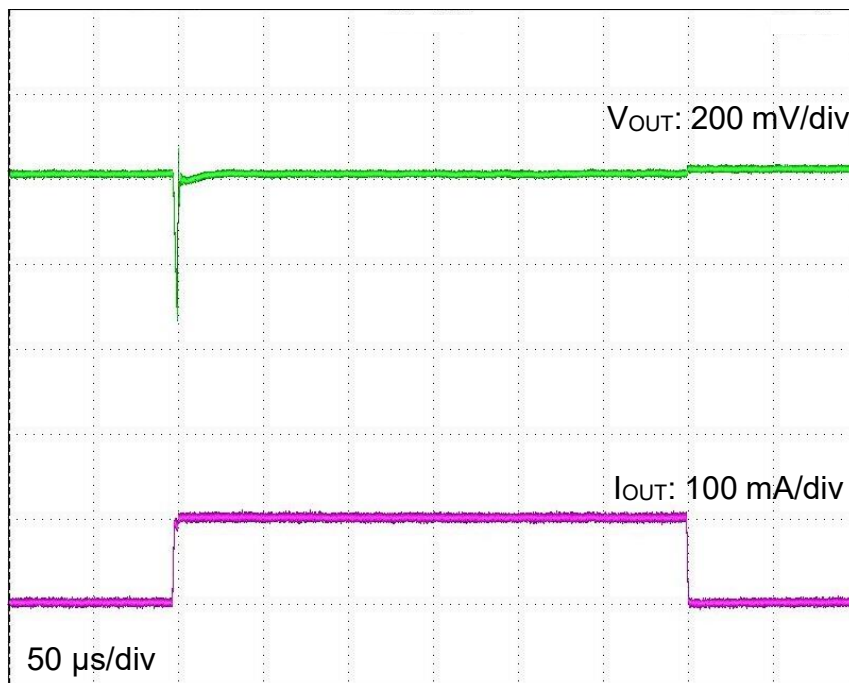

Note: The above characteristics curves are presented for reference only and not guaranteed by production test, unless otherwise noted.

11. Package Information

WCSP4F

Unit: mm

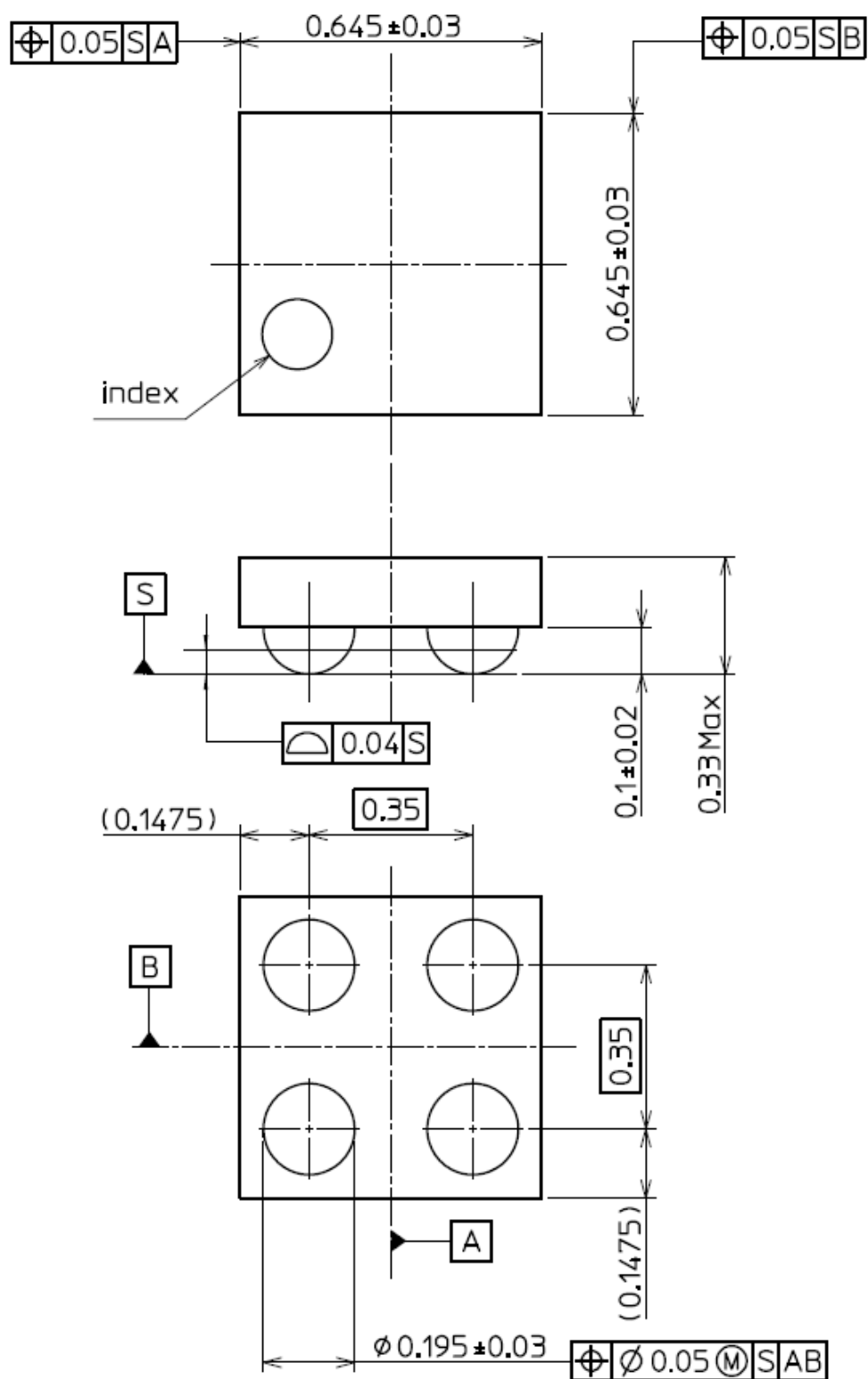

Weight: 0.26 mg (Typ.)

Figure 11.1 Package Dimensions

RESTRICTIONS ON PRODUCT USE

Toshiba Corporation and its subsidiaries and affiliates are collectively referred to as "TOSHIBA". Hardware, software and systems described in this document are collectively referred to as "Product".

- TOSHIBA reserves the right to make changes to the information in this document and related Product without notice.
- This document and any information herein may not be reproduced without prior written permission from TOSHIBA. Even with TOSHIBA's written permission, reproduction is permissible only if reproduction is without alteration/omission.
- Though TOSHIBA works continually to improve Product's quality and reliability, Product can malfunction or fail. Customers are responsible for complying with safety standards and for providing adequate designs and safeguards for their hardware, software and systems which minimize risk and avoid situations in which a malfunction or failure of Product could cause loss of human life, bodily injury or damage to property, including data loss or corruption. Before customers use the Product, create designs including the Product, or incorporate the Product into their own applications, customers must also refer to and comply with (a) the latest versions of all relevant TOSHIBA information, including without limitation, this document, the specifications, the data sheets and application notes for Product and the precautions and conditions set forth in the "TOSHIBA Semiconductor Reliability Handbook" and (b) the instructions for the application with which the Product will be used with or for. Customers are solely responsible for all aspects of their own product design or applications, including but not limited to (a) determining the appropriateness of the use of this Product in such design or applications; (b) evaluating and determining the applicability of any information contained in this document, or in charts, diagrams, programs, algorithms, sample application circuits, or any other referenced documents; and (c) validating all operating parameters for such designs and applications. **TOSHIBA ASSUMES NO LIABILITY FOR CUSTOMERS' PRODUCT DESIGN OR APPLICATIONS.**
- **PRODUCT IS NEITHER INTENDED NOR WARRANTED FOR USE IN EQUIPMENTS OR SYSTEMS THAT REQUIRE EXTRAORDINARILY HIGH LEVELS OF QUALITY AND/OR RELIABILITY, AND/OR A MALFUNCTION OR FAILURE OF WHICH MAY CAUSE LOSS OF HUMAN LIFE, BODILY INJURY, SERIOUS PROPERTY DAMAGE AND/OR SERIOUS PUBLIC IMPACT ("UNINTENDED USE").** Except for specific applications as expressly stated in this document, Unintended Use includes, without limitation, equipment used in nuclear facilities, equipment used in the aerospace industry, lifesaving and/or life supporting medical equipment, equipment used for automobiles, trains, ships and other transportation, traffic signaling equipment, equipment used to control combustions or explosions, safety devices, elevators and escalators, and devices related to power plant. **IF YOU USE PRODUCT FOR UNINTENDED USE, TOSHIBA ASSUMES NO LIABILITY FOR PRODUCT.** For details, please contact your TOSHIBA sales representative or contact us via our website.
- Do not disassemble, analyze, reverse-engineer, alter, modify, translate or copy Product, whether in whole or in part.
- Product shall not be used for or incorporated into any products or systems whose manufacture, use, or sale is prohibited under any applicable laws or regulations.
- The information contained herein is presented only as guidance for Product use. No responsibility is assumed by TOSHIBA for any infringement of patents or any other intellectual property rights of third parties that may result from the use of Product. No license to any intellectual property right is granted by this document, whether express or implied, by estoppel or otherwise.
- **ABSENT A WRITTEN SIGNED AGREEMENT, EXCEPT AS PROVIDED IN THE RELEVANT TERMS AND CONDITIONS OF SALE FOR PRODUCT, AND TO THE MAXIMUM EXTENT ALLOWABLE BY LAW, TOSHIBA (1) ASSUMES NO LIABILITY WHATSOEVER, INCLUDING WITHOUT LIMITATION, INDIRECT, CONSEQUENTIAL, SPECIAL, OR INCIDENTAL DAMAGES OR LOSS, INCLUDING WITHOUT LIMITATION, LOSS OF PROFITS, LOSS OF OPPORTUNITIES, BUSINESS INTERRUPTION AND LOSS OF DATA, AND (2) DISCLAIMS ANY AND ALL EXPRESS OR IMPLIED WARRANTIES AND CONDITIONS RELATED TO SALE, USE OF PRODUCT, OR INFORMATION, INCLUDING WARRANTIES OR CONDITIONS OF MERCHANTABILITY, FITNESS FOR A PARTICULAR PURPOSE, ACCURACY OF INFORMATION, OR NONINFRINGEMENT.**
- Do not use or otherwise make available Product or related software or technology for any military purposes, including without limitation, for the design, development, use, stockpiling or manufacturing of nuclear, chemical, or biological weapons or missile technology products (mass destruction weapons). Product and related software and technology may be controlled under the applicable export laws and regulations including, without limitation, the Japanese Foreign Exchange and Foreign Trade Law and the U.S. Export Administration Regulations. Export and re-export of Product or related software or technology are strictly prohibited except in compliance with all applicable export laws and regulations.
- Please contact your TOSHIBA sales representative for details as to environmental matters such as the RoHS compatibility of Product. Please use Product in compliance with all applicable laws and regulations that regulate the inclusion or use of controlled substances, including without limitation, the EU RoHS Directive. **TOSHIBA ASSUMES NO LIABILITY FOR DAMAGES OR LOSSES OCCURRING AS A RESULT OF NONCOMPLIANCE WITH APPLICABLE LAWS AND REGULATIONS.**