



**Please note that Cypress is an Infineon Technologies Company.**

The document following this cover page is marked as “Cypress” document as this is the company that originally developed the product. Please note that Infineon will continue to offer the product to new and existing customers as part of the Infineon product portfolio.

**Continuity of document content**

The fact that Infineon offers the following product as part of the Infineon product portfolio does not lead to any changes to this document. Future revisions will occur when appropriate, and any changes will be set out on the document history page.

**Continuity of ordering part numbers**

Infineon continues to support existing part numbers. Please continue to use the ordering part numbers listed in the datasheet for ordering.



**AN INFINEON TECHNOLOGIES COMPANY**

**THIS SPEC IS OBSOLETE**

Spec No: 002-11317

Spec Title: CYALKIT-E02 SOLAR-POWERED BLE SENSOR BEACON  
REFERENCE DESIGN KIT GUIDE

Replaced by: NONE



CYALKIT-E02

# Solar-Powered BLE Sensor Beacon Reference Design Kit Guide

Document Number. 002-11317 Rev. \*E

Cypress Semiconductor  
198 Champion Court  
San Jose, CA 95134-1709  
[www.cypress.com](http://www.cypress.com)

© Cypress Semiconductor Corporation, 2016-2022. This document is the property of Cypress Semiconductor Corporation and its subsidiaries (“Cypress”). This document, including any software or firmware included or referenced in this document (“Software”), is owned by Cypress under the intellectual property laws and treaties of the United States and other countries worldwide. Cypress reserves all rights under such laws and treaties and does not, except as specifically stated in this paragraph, grant any license under its patents, copyrights, trademarks, or other intellectual property rights. If the Software is not accompanied by a license agreement and you do not otherwise have a written agreement with Cypress governing the use of the Software, then Cypress hereby grants you a personal, non-exclusive, nontransferable license (without the right to sublicense) (1) under its copyright rights in the Software (a) for Software provided in source code form, to modify and reproduce the Software solely for use with Cypress hardware products, only internally within your organization, and (b) to distribute the Software in binary code form externally to end users (either directly or indirectly through resellers and distributors), solely for use on Cypress hardware product units, and (2) under those claims of Cypress’s patents that are infringed by the Software (as provided by Cypress, unmodified) to make, use, distribute, and import the Software solely for use with Cypress hardware products. Any other use, reproduction, modification, translation, or compilation of the Software is prohibited.

TO THE EXTENT PERMITTED BY APPLICABLE LAW, CYPRESS MAKES NO WARRANTY OF ANY KIND, EXPRESS OR IMPLIED, WITH REGARD TO THIS DOCUMENT OR ANY SOFTWARE OR ACCOMPANYING HARDWARE, INCLUDING, BUT NOT LIMITED TO, THE IMPLIED WARRANTIES OF MERCHANTABILITY AND FITNESS FOR A PARTICULAR PURPOSE. No computing device can be absolutely secure. Therefore, despite security measures implemented in Cypress hardware or software products, Cypress shall have no liability arising out of any security breach, such as unauthorized access to or use of a Cypress product. CYPRESS DOES NOT REPRESENT, WARRANT, OR GUARANTEE THAT CYPRESS PRODUCTS, OR SYSTEMS CREATED USING CYPRESS PRODUCTS, WILL BE FREE FROM CORRUPTION, ATTACK, VIRUSES, INTERFERENCE, HACKING, DATA LOSS OR THEFT, OR OTHER SECURITY INTRUSION (collectively, “Security Breach”). Cypress disclaims any liability relating to any Security Breach, and you shall and hereby do release Cypress from any claim, damage, or other liability arising from any Security Breach. In addition, the products described in these materials may contain design defects or errors known as errata which may cause the product to deviate from published specifications. To the extent permitted by applicable law, Cypress reserves the right to make changes to this document without further notice. Cypress does not assume any liability arising out of the application or use of any product or circuit described in this document. Any information provided in this document, including any sample design information or programming code, is provided only for reference purposes. It is the responsibility of the user of this document to properly design, program, and test the functionality and safety of any application made of this information and any resulting product. “High-Risk Device” means any device or system whose failure could cause personal injury, death, or property damage. Examples of High-Risk Devices are weapons, nuclear installations, surgical implants, and other medical devices. “Critical Component” means any component of a High-Risk Device whose failure to perform can be reasonably expected to cause, directly or indirectly, the failure of the High-Risk Device, or to affect its safety or effectiveness. Cypress is not liable, in whole or in part, and you shall and hereby do release Cypress from any claim, damage, or other liability arising from any use of a Cypress product as a Critical Component in a High-Risk Device. You shall indemnify and hold Cypress, its directors, officers, employees, agents, affiliates, distributors, and assigns harmless from and against all claims, costs, damages, and expenses, arising out of any claim, including claims for product liability, personal injury or death, or property damage arising from any use of a Cypress product as a Critical Component in a High-Risk Device. Cypress products are not intended or authorized for use as a Critical Component in any High-Risk Device except to the limited extent that (i) Cypress’s published data sheet for the product explicitly states Cypress has qualified the product for use in a specific High-Risk Device, or (ii) Cypress has given you advance written authorization to use the product as a Critical Component in the specific High-Risk Device and you have signed a separate indemnification agreement.

Cypress, the Cypress logo, Spansion, the Spansion logo, and combinations thereof, WICED, PSoC, CapSense, EZ-USB, F-RAM, and Traveo are trademarks or registered trademarks of Cypress in the United States and other countries. For a more complete list of Cypress trademarks, visit [cypress.com](http://cypress.com). Other names and brands may be claimed as property of their respective owners.

# Contents



<b>Safety Information</b> .....	<b>5</b>
Regulatory Compliance .....	5
General Safety Instructions .....	6
<b>1. Introduction</b> .....	<b>7</b>
1.1 Kit Introduction.....	7
1.2 Block Diagrams .....	8
1.3 Features .....	9
<b>2. Software Installation</b> .....	<b>11</b>
2.1 Install Cypress BLE-Beacon Software.....	11
2.2 Install RDK Software .....	12
2.3 Uninstall Software.....	14
2.4 PSoC Creator™.....	14
<b>3. Getting Started</b> .....	<b>15</b>
3.1 WSN Operation with PC .....	15
3.2 WSN Operation with Mobile Device.....	22
3.3 Configuring Solar BLE Sensor.....	26
3.4 Serial Command List .....	31
3.5 Eddystone-URL Configuration Service .....	40
3.6 Note About Validators.....	40
<b>4. Program and Debug</b> .....	<b>42</b>
4.1 KitProg.....	42
4.2 Programming and Debugging.....	42
4.3 Updating KitProg Firmware.....	47
<b>5. Reference Design</b> .....	<b>48</b>
5.1 Hardware Description .....	48
5.2 Firmware Description.....	56
5.3 BLE Beacon Format .....	67
5.4 Eddystone Format .....	69
<b>6. Hardware</b> .....	<b>71</b>
6.1 Solar BLE Sensor .....	71
6.2 Debug Board .....	77

<b>Appendix A. Advanced Topics</b> .....	<b>82</b>
A.1 Battery Input Operation .....	82
A.2 Charging the Supercapacitor .....	83
A.3 Equivalent Series Resistance of the Supercapacitor .....	84
A.4 Diode Connection Between Solar Cell and VDD .....	85
<b>Appendix B. Solar BLE Sensor Enclosure</b> .....	<b>87</b>
B.1 Solar BLE Sensor Enclosure .....	87
B.2 How to Install the Board in the Enclosure .....	88
<b>Revision History</b> .....	<b>90</b>

# Safety Information



## Regulatory Compliance

The CYALKIT-E02 Solar-Powered Bluetooth Low Energy (BLE) Sensor Beacon Reference Design Kit (RDK) is intended for use as a development platform for hardware or software in a laboratory environment. The board is an open system design, which does not include a shielded enclosure. This may cause interference with other electrical or electronic devices in close proximity. In a domestic environment, this product may cause radio interference. In this case, the user may be required to take adequate preventive measures. Also, the board should not be used near any medical equipment or RF devices.

Attaching additional wiring to this product or modifying the product operation from the factory default may affect its performance and cause interference with other apparatus in the immediate vicinity. If such interference is detected, suitable mitigating measures should be taken.



The CYALKIT-E02 Solar-Powered BLE Sensor Beacon RDK as shipped from the factory has been verified to meet the requirements of CE as a Class A product.



The CYALKIT-E02 Solar-Powered BLE Sensor Beacon RDK contains electrostatic discharge (ESD) sensitive devices. Electrostatic charges readily accumulate on the human body and any equipment and can discharge without detection. Permanent damage may occur to devices subjected to high-energy discharges. Proper ESD precautions are recommended to avoid performance degradation or loss of functionality. Store unused CYALKIT-E02 boards in the protective shipping package.



### End of Life/Product Recycling

The end of life of this kit is five years after the date of manufacture mentioned on the back of the box. Contact your nearest recycler to discard the kit.

## General Safety Instructions

### ESD Protection

ESD can damage boards and their associated components. Cypress recommends that you perform procedures only at an ESD workstation. If one is not available, use appropriate ESD protection by wearing an antistatic wrist strap attached to chassis ground (any unpainted metal surface) on your board when handling parts.

### Handling Boards

CYALKIT-E02 boards are sensitive to ESD. Hold the board only by its edges. After removing the board from its box, place it on a grounded, static-free surface. Use a conductive foam pad, if available. Do not slide the board over any surface.



# 1. Introduction



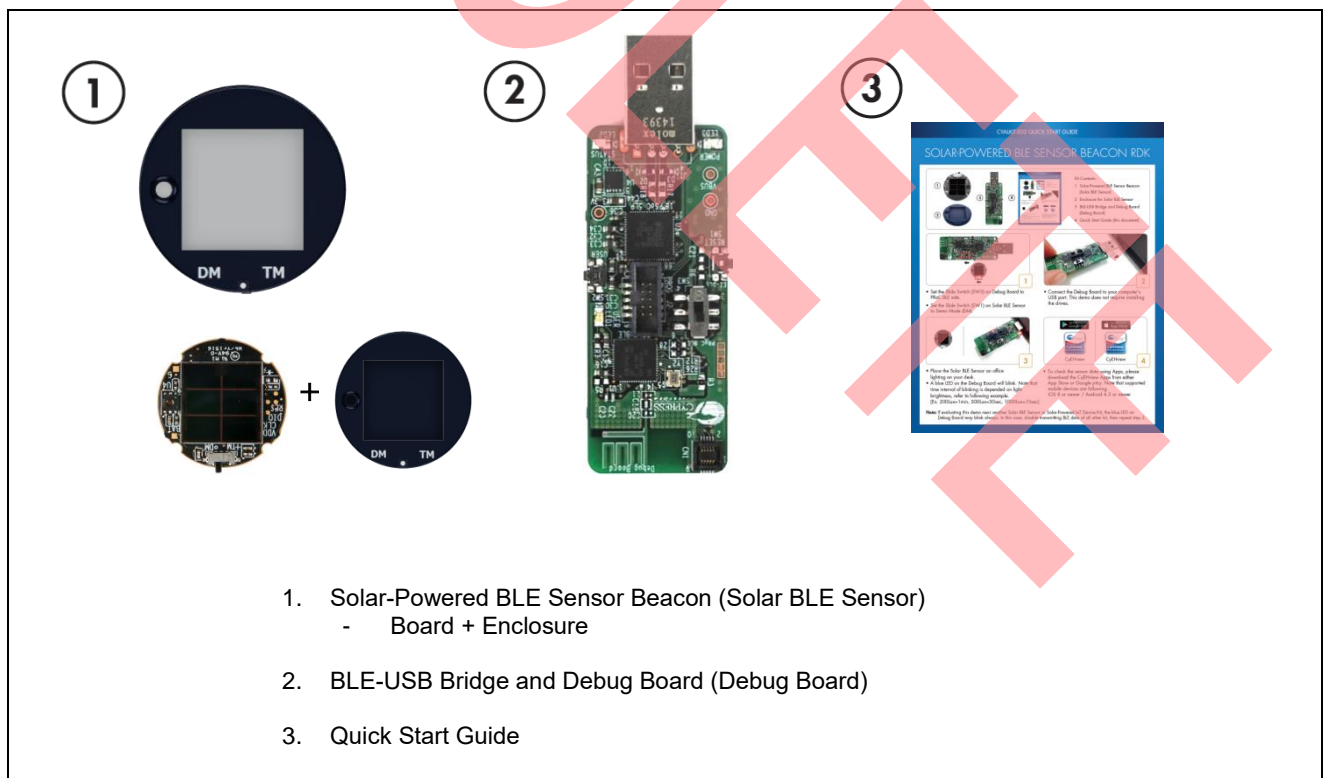
Thank you for your interest in the CYALKIT-E02 Solar-Powered BLE Sensor Beacon RDK. The Solar-Powered BLE Sensor Beacon RDK provides an easy-to-use platform for the development of a tiny solar-powered IoT device with BLE wireless connectivity. The RDK consists of a Solar BLE Sensor and a Debug Board. The Solar BLE Sensor is based on Cypress's energy harvesting power management IC (PMIC) S6AE103A and EZ-BLE products. The objective of this RDK is to provide a fully functional battery-less wireless sensor node (WSN). The Solar BLE Sensor will be enclosed in a casing to automatically transmit temperature and humidity sensor data in an office lighting environment. The Debug Board is based on Cypress's ProC™ BLE and PsoC® 5LP products. It can be connected to a host (PC) that supports the Debug Board and on-chip debugging via a USB interface.

This kit guide explains how to set up and use the RDK. Be sure to read it before using the product. For questions, please consult with sales or support representatives.

**Note:** All information included in this document is current as of the date it was issued. Such information is subject to change without any prior notice. Please confirm the latest relevant information with the sales representative.

## 1.1 Kit Introduction

Figure 1-1. Kit Contents



## 1.2 Block Diagrams

Figure 1-2. Block Diagram of Solar BLE Sensor

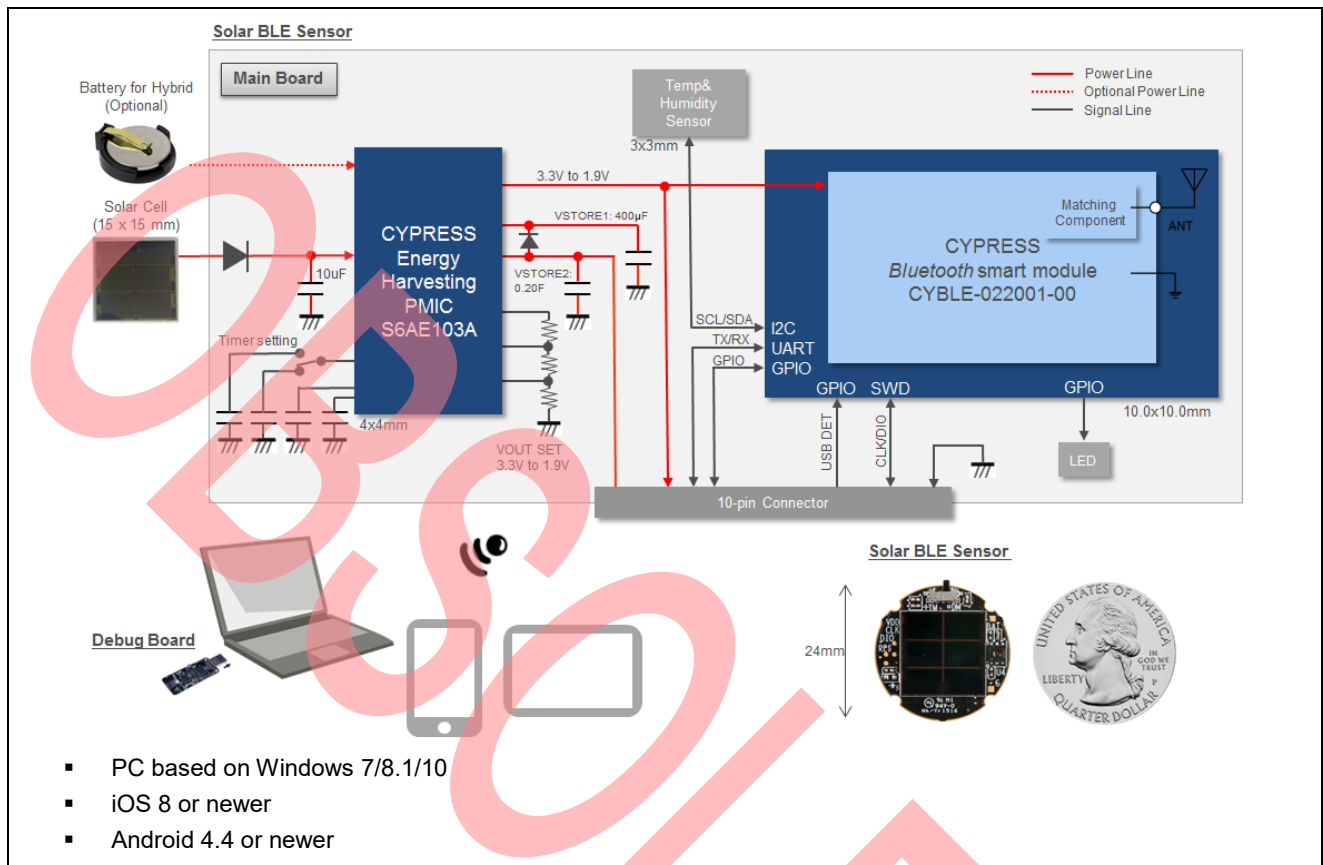
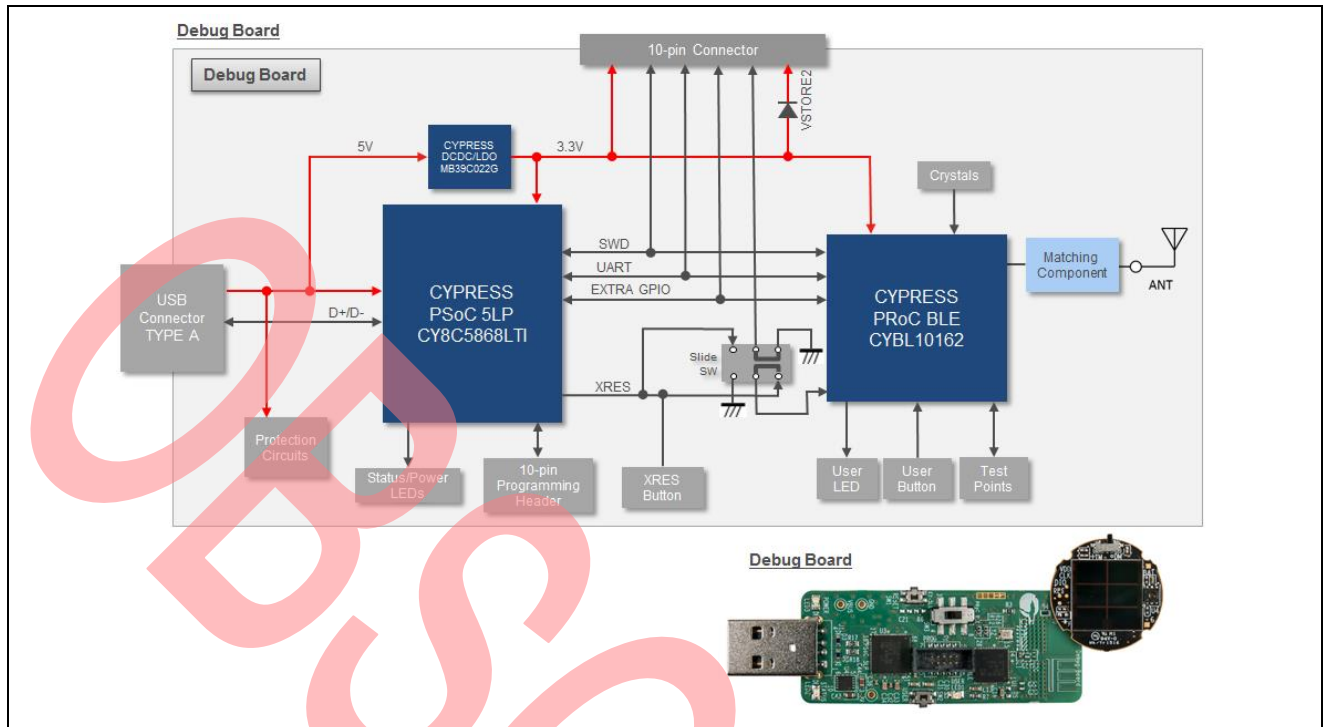


Figure 1-3. Block Diagram of Debug Board



### 1.3 Features

The Solar-Powered BLE Sensor Beacon RDK provides everything needed to develop a light-powered sensor node that transmits sensor data using Bluetooth Low Energy (BLE):

- Tiny solar-powered BLE sensor board (circle with 24-mm diameter, same size as a 25-cent coin)
- Operates using light energy harvested (>100 lux) by the included solar cell
- Supports BLE communication with a PC through the provided Debug Board that is preprogrammed with custom firmware for this kit
- Supports BLE communication with a mobile device (iOS 8 or newer / Android 4.4 or newer)
- Includes firmware that supports a BLE Beacon transmission with temperature and humidity data
- Energy harvesting PMIC S6AE103A that supports the following applications:
  - Demo mode, transmitting sensor data at 3- to 60-second intervals (without charging to a supercapacitor)
  - Timer mode, transmitting sensor data at 5-minute intervals while charging to the supercapacitor
  - Transmitting data at over 30 hours without ambient light (when mode is set to Timer mode and supercapacitor is fully charged)
- Solar BLE Sensor that can support the following:
  - Selection of mode using a slide switch (Demo or Timer mode)
  - Programming and debugging of the EZ-BLE module via the Debug Board
  - Parameter setting of the BLE Beacon via the Debug Board
  - Charging of surplus solar energy to a 0.2-F supercapacitor (Timer mode)
  - Charging of the supercapacitor via the Debug Board using USB bus power
  - Temperature and humidity digital sensor

- Expandable interface via 10-pin connector (GPIO)
- Test pads for power, ground, primary battery input, and SWD interface for programming
- Debug board that can support the following:
  - Debug board for receiving BLE data
  - Selecting the programming mode using a slide switch (EZ-BLE on Solar BLE Sensor or ProC BLE on Debug Board)
  - Connector for Solar BLE Sensor (power, SWD, UART, USB detect, charging supercapacitor, and GPIO)
  - Connector for programming PsoC 5LP (KitProg)
  - Parameter setting of Solar BLE Sensor via USB-to-UART bridge on KitProg
  - Reset button for EZ-BLE and ProC BLE
  - User button for ProC BLE
  - LEDs for User, Status and USB power
  - Test pads for power, ground and expandable GPIO
- Includes reference schematic, BOM list, layout, and sample firmware for easy design
- Uses the following Cypress devices:
  - S6AE103A ultra-low-power energy harvesting PMIC
  - CYBLE-022001-00 EZ-BLE ProC module
  - CYBL10162-56L ProC BLE IC
  - CY8C5868L PsoC 5LP for KitProg
  - MB39C022G LDO

## 2. Software Installation

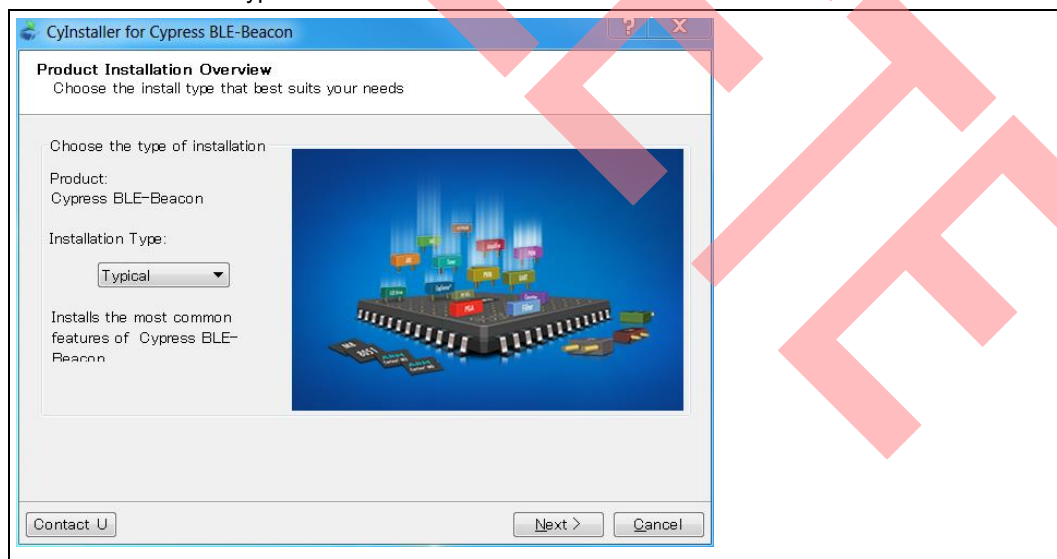


This section describes how to install the software.

### 2.1 Install Cypress BLE-Beacon Software

Follow these steps to install the Cypress BLE-Beacon software:

1. Download and install the Cypress BLE-Beacon software from [www.cypress.com/CypressBLE-Beacon-PC](http://www.cypress.com/CypressBLE-Beacon-PC). The software is available in two different formats for download:
  - Cypress® BLE-Beacon™ PC: This executable file installs only the software contents, which include software files, and user documents. This package can be used if all the software prerequisites are installed on your computer.
  - Cypress® BLE-Beacon™ PC ISO (Create CD): This file is a complete package, stored in a CD-ROM image format that can be used to create a CD, or extract using ISO extraction programs, such as WinZip or WinRAR. This file includes all the required software and user documents.
2. Run Install Cypress BLE-Beacon to start the installation, as shown below.
3. Select the folder to install the Cypress BLE-Beacon-related files. Choose the directory and click **Next**.
4. The Cypress BLE-Beacon installer automatically installs the required software, if it is not present on your computer. The Setup installer directs you to download the required software from the Internet.
5. Choose the **Typical/Custom/Complete** installation type in the **Product Installation Overview** window. Click **Next** after you select the installation type.



6. Read the **Cypress End User License Agreement** and make a selection based on the terms of the license agreement. Click **Next** to continue the installation.

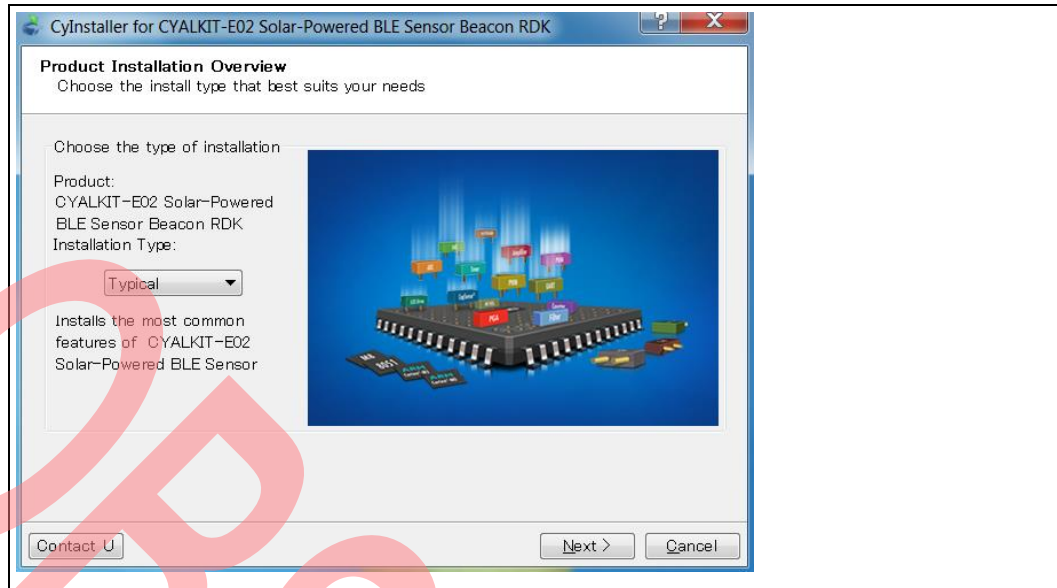


7. When the installation begins, a list of packages appears on the installation page. A green check mark appears next to each package after successful installation.
8. Click **Finish** to complete the Cypress BLE-Beacon installation.
9. Enter your contact information or select the **Continue Without Contact Information** check box. Click **Finish** to complete the Cypress BLE-Beacon installation.
10. After the installation is complete, the kit contents are available at the following location:  
 <Install directory>\Cypress BLE-Beacon  
 Default location (Example: Windows 7)
  - 64-bit: C:\Program Files (x86)\Cypress\Cypress BLE-Beacon
  - 32-bit: C:\Program Files\Cypress\Cypress BLE-Beacon

## 2.2 Install RDK Software

Follow these steps to install the CYALKIT-E02 Solar-Powered BLE Sensor Beacon RDK software:

1. Download and install the CYALKIT-E02 software from [www.cypress.com/CYALKIT-E02](http://www.cypress.com/CYALKIT-E02). The CYALKIT-E02 software is available in three different formats for download:
  - CYALKIT-E02 Complete Setup: This installation package contains the files related to the kit. However, it does not include the Windows Installer or Microsoft .NET framework packages. If these packages are not on your computer, the installer directs you to download and install them from the Internet.
  - CYALKIT-E02 Only Package: This executable file installs only the kit contents, which include code examples, hardware files, and user documents. This package can be used if all the software prerequisites are installed on your computer.
  - CYALKIT-E02 CD ISO: This file is a complete package, stored in a CD-ROM image format that can be used to create a CD, or extract using ISO extraction programs, such as WinZip or WinRAR. This file includes all the required software, utilities, drivers, hardware files, and user documents.
2. Run Install CYALKIT-E02 to start the installation, as shown below.
3. Select the folder to install the CYALKIT-E02-related files. Choose the directory and click **Next**.
4. The CYALKIT-E02 installer automatically installs the required software if it is not present on your computer. The CYALKIT-E02 Setup installer directs you to download the required software from the Internet.
5. Choose the **Typical/Custom/Complete** installation type in the **Product Installation Overview** window. Click **Next** after you select the installation type.



6. Read the **Cypress End User License Agreement** and make a selection based on the terms of the license agreement. Click **Next** to continue the installation.



7. When the installation begins, a list of packages appears on the installation page. A green check mark appears next to each package after successful installation.
8. Click **Finish** to complete the CYALKIT-E02 installation.
9. Enter your contact information or select the **Continue Without Contact Information** check box. Click **Finish** to complete the CYALKIT-E02 installation.
10. After the installation is complete, the kit contents are available at the following location:  
*<Install directory>\CYALKIT-E02 Solar-Powered BLE Sensor Beacon RDK*  
 Default location (Example: Windows 7)
  - 64-bit: C:\Program Files (x86)\Cypress\CYALKIT-E02 Solar-Powered BLE Sensor Beacon RDK
  - 32-bit: C:\Program Files\Cypress\CYALKIT-E02 Solar-Powered BLE Sensor Beacon RDK

## 2.3 Uninstall Software

You can uninstall the Solar-Powered BLE Sensor Beacon RDK software and Cypress BLE-Beacon software using one of the following methods:

Example: Windows 7

- Go to Start > All Programs > Cypress > Cypress Update Manager; click the Uninstall button.
- Go to Start > Control Panel > Programs and Features. Select the Solar-Powered BLE Sensor Beacon RDK program from the list and click the Uninstall/Change button.

## 2.4 PsoC Creator™

PsoC Creator is a state-of-the-art, easy-to-use integrated design environment (IDE). It is a revolutionary hardware and software co-design environment, powered by a library of preverified and precharacterized PsoC Components. With PsoC Creator, you can:

- Drag and drop PsoC Components to build a schematic of your custom design
- Automatically place and route Components and configure GPIOs
- Develop and debug firmware using the included Component APIs

PsoC Creator also enables you to tap into an entire tool ecosystem with integrated compiler chains and production programmers for PsoC devices.

To develop firmware for the Solar-Powered BLE Sensor Beacon RDK, you must have PsoC Creator 3.3 SP2 or newer. Download the latest version from [www.cypress.com/psoccreator](http://www.cypress.com/psoccreator).

For sample firmware information for this kit, refer to section [Firmware Description](#).



# 3. Getting Started



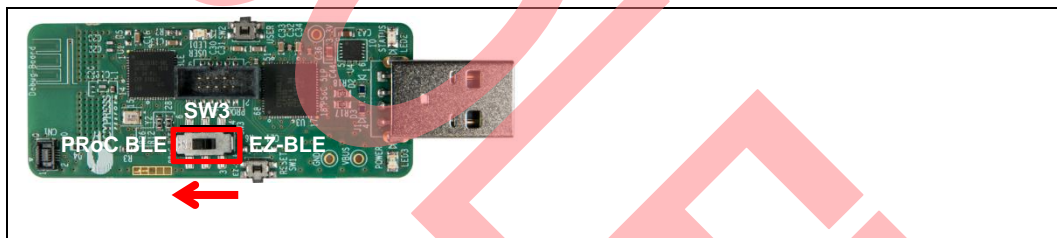
In this chapter, you will become familiar with the Solar-Powered BLE Sensor Beacon RDK by successfully establishing a BLE sensor beacon connection between the Solar BLE Sensor operating as a wireless sensor network (WSN), a PC with the Debug Board, and a mobile device with apps. This will also confirm that the Solar BLE Sensor, the Debug Board, your PC, and your mobile device are operating properly.

## 3.1 WSN Operation with PC

In this section, you will confirm that the Solar BLE Sensor is operating as a WSN by using the software provided on your PC to detect temperature and humidity changes.

### 3.1.1 USB Driver Installation of Debug Board

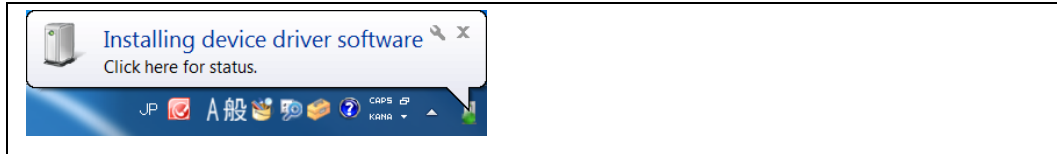
1. Set the slide switch (SW3) on the Debug Board to the ProC BLE side. Refer to [Slide Switch for Target Device Select](#) for detailed information on each mode.



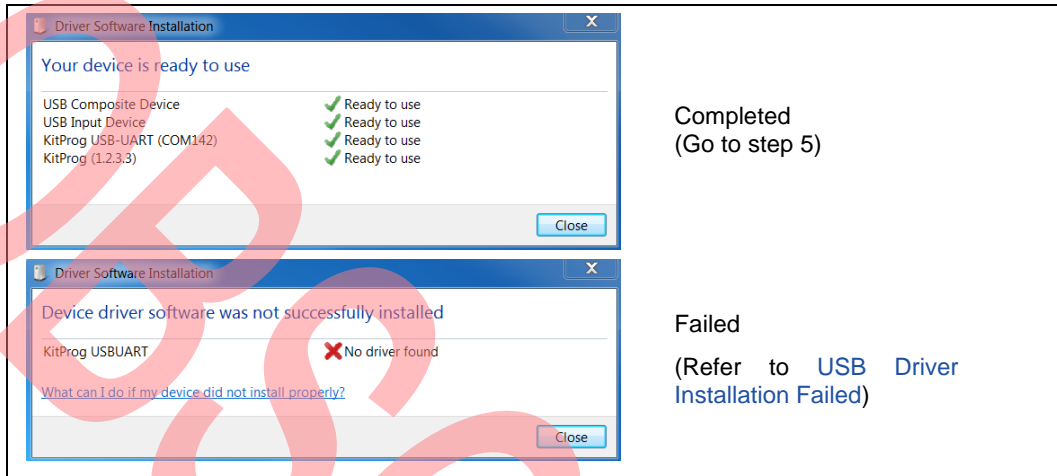
2. Plug the Debug Board into your computer's USB port.



3. The driver Installation starts automatically and the following message window will appear. Click the message window for the status.



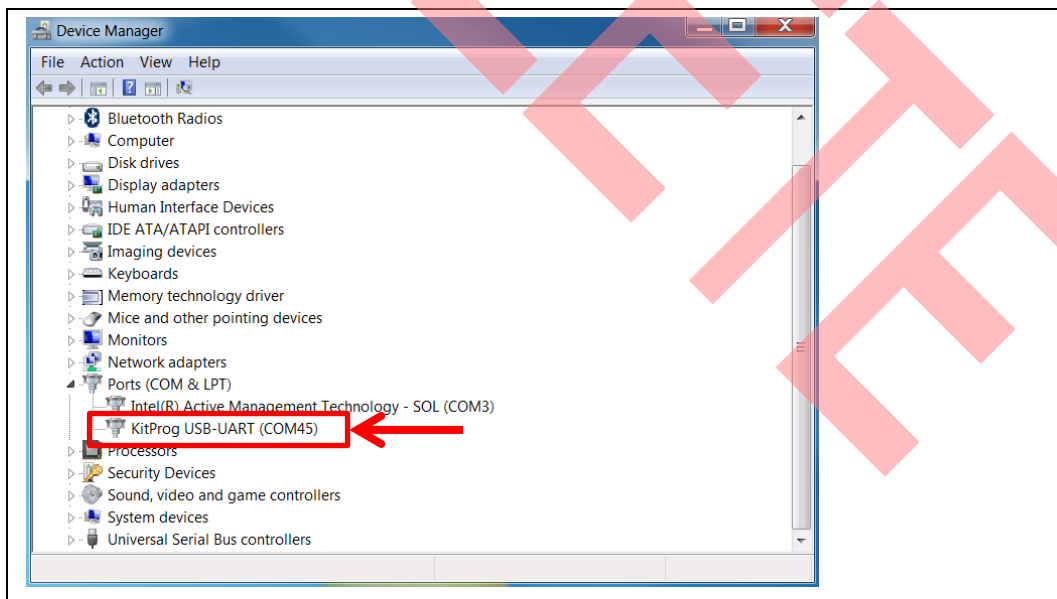
4. Confirm that the device driver installation has successfully completed (all components are “Ready to use”). If the installation fails, do the installation manually using a file in the “USB drivers” folder. Refer to [3.1.2 USB Driver Installation Failed](#).



Completed  
(Go to step 5)

Failed  
(Refer to [USB Driver Installation Failed](#))

5. After successful device driver installation, confirm that a new COM port called “KitProg USB-UART” was added:  
Open the Device Manager:
  - Windows 7: **Start > Control Panel > Device Manager**
  - Windows 8/8.1/10: Right-click the Start button and select **Device Manager**.
- B. Under **Ports (COM & LPT)**, confirm that a COM port called “KitProg USB-UART” was added. Note the COM number (COMxx).

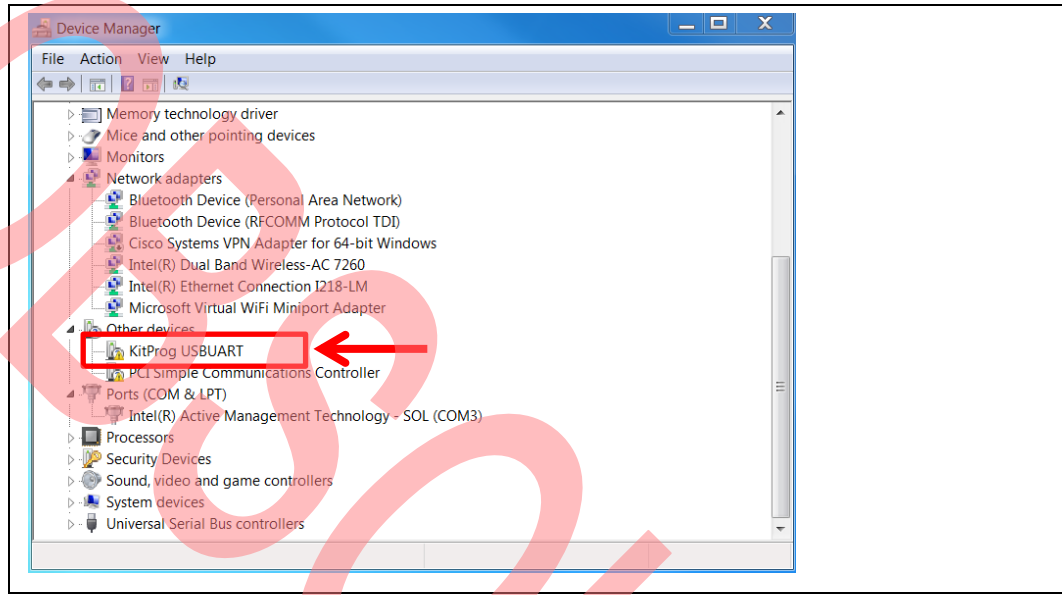


6. Continue as described in [3.1.3 Establishing BLE Connection](#).

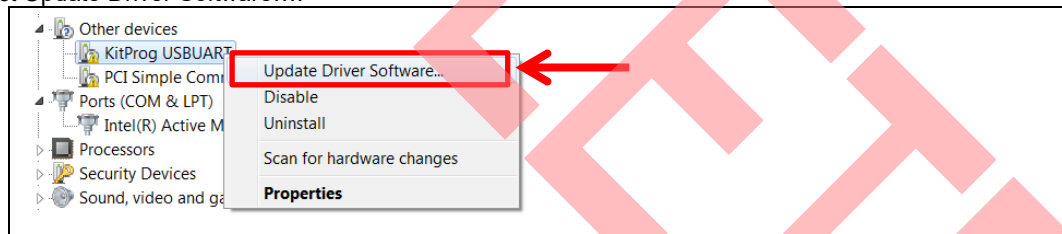
### 3.1.2 USB Driver Installation Failed

If the device driver installation fails, confirm that an unconfigured KitProg USB-UART appears in the **Device Manager**:

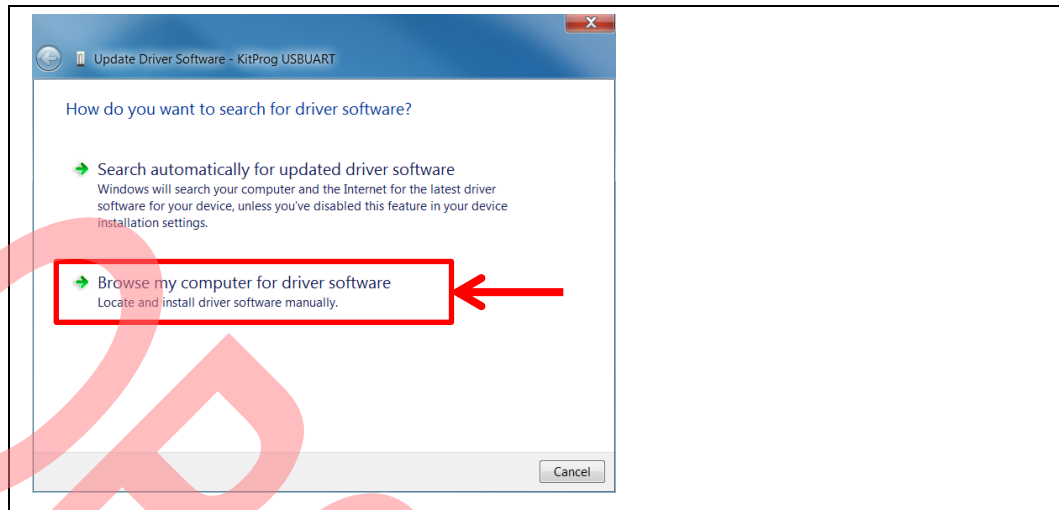
1. Open the **Device Manager**:
  - Windows 7: Start > Control Panel > Device Manager
  - Windows 8/8.1/10: Right-click the Start button and select Device Manager.
2. Under **Other devices**, confirm that KitProg USB-UART appears with no associated COM port.



3. Update the USB driver software or the unconfigured "KitProg USB-UART."
  - A. Click the right mouse button on "KitProg USB-UART."
  - B. Select Update Driver Software....



4. Select **Browse my computer for driver software**.



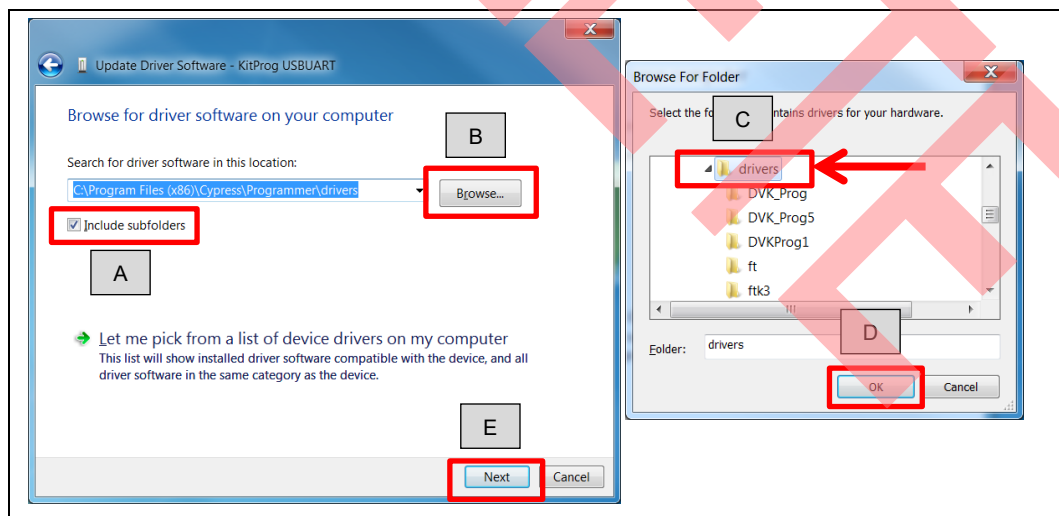
5. Search for the USB driver in the PsoC Programmer folder.

Default location (Example: Windows 7)

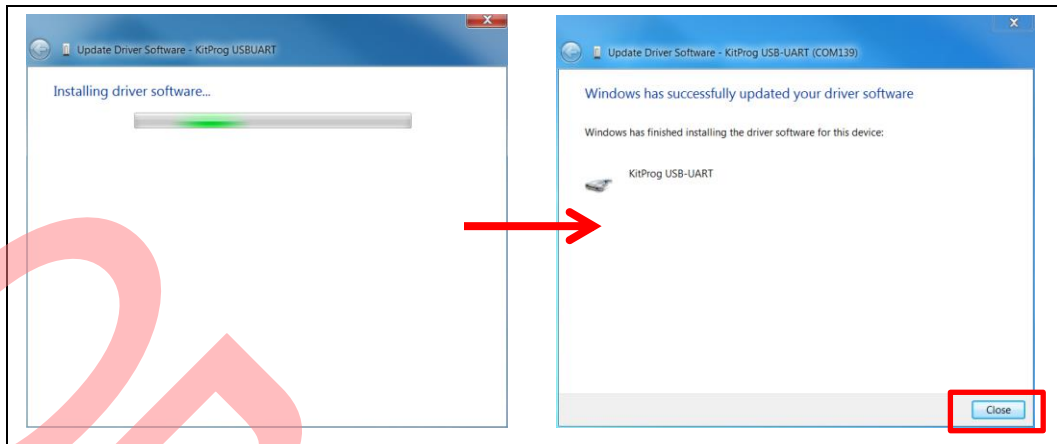
- 64-bit: *C:\Program Files (x86)\Cypress\Programmer\drivers*
- 32-bit: *C:\Program Files\Cypress\Programmer\drivers*

If there is no folder for PsoC Programmer, please download and install it from [PsoC Programmer](#) page. The recommend version is 3.24 or later.

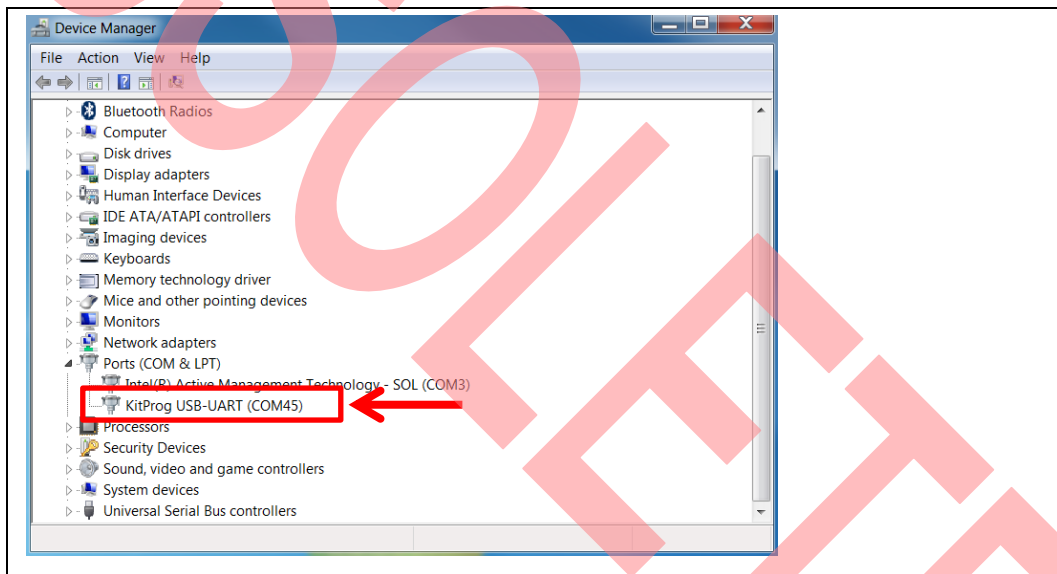
- A. Select the **Include subfolders** box.
- B. Click the **Browse...** button.
- C. Select the “drivers” folder of PsoC Programmer:  
*<Install directory>\Programmer\drivers*
- D. Click the **OK** button.
- E. Click the **Next** button.



- Start installing the USB driver. Click the **Close** button when the KitProg USB-UART driver installation finishes.

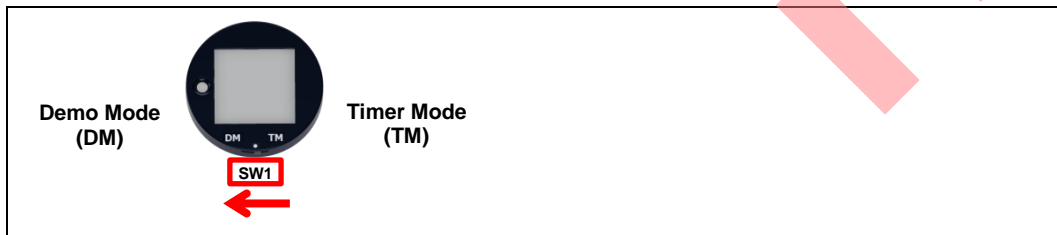


- After successful device driver installation, confirm that a new COM port called “KitProg USB-UART” was added:
  - Open the **Device Manager**.
  - Under **Ports (COM & LPT)**, confirm that a COM port called “KitProg USB-UART” was added. Note the COM number (COMxx).



### 3.1.3 Establishing BLE Connection

- Set the slide switch (SW1) on the Solar BLE Sensor to Demo mode (DM). Refer to [5.1.4.1 Waveform of Demo Mode and Timer Mode](#) for detailed information on each mode.



**Note:** Use the sharp end of something like tweezers (not included in the kit) to change the mode.

- Place the Solar BLE Sensor under an office light. The firmware to operate the Solar BLE Sensor as a BLE sensor beacon is preloaded from the factory. After placing the Solar BLE Sensor under a suitable light (refer to [Table 3-1. Light Level Versus Time Interval](#)), it will automatically power up and begin transmitting.

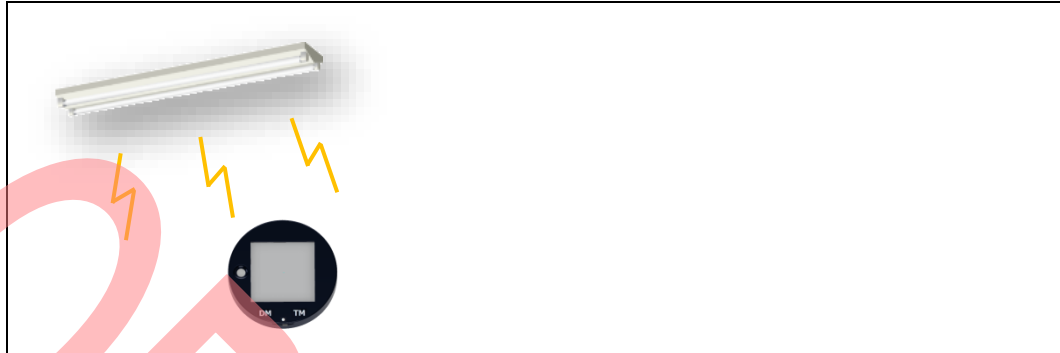


Table 3-1. Light Level Versus Time Interval

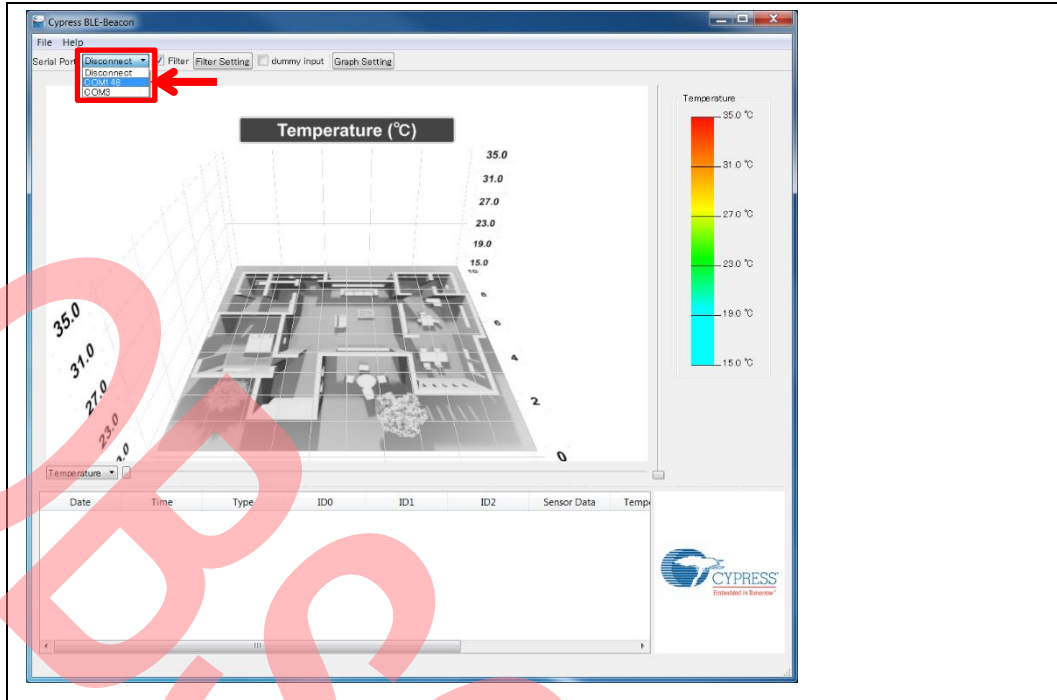
Typical Light Level	Environment	Time Interval of Sensor <sup>1</sup>
~1 lx	Moonlight	Does not work
100 lx~200 lx	Under street lighting	50 s ~
200 lx~400 lx	At museum	30 s ~ 50 s
400 lx~500 lx	Office lighting	15 s ~ 30 s
1000 lx ~	Shopping mall, rainy day	3 s ~ 15 s

<sup>1</sup>The time interval of the sensor is three seconds in all light levels when the supercapacitor on the Solar BLE Sensor is fully charged.

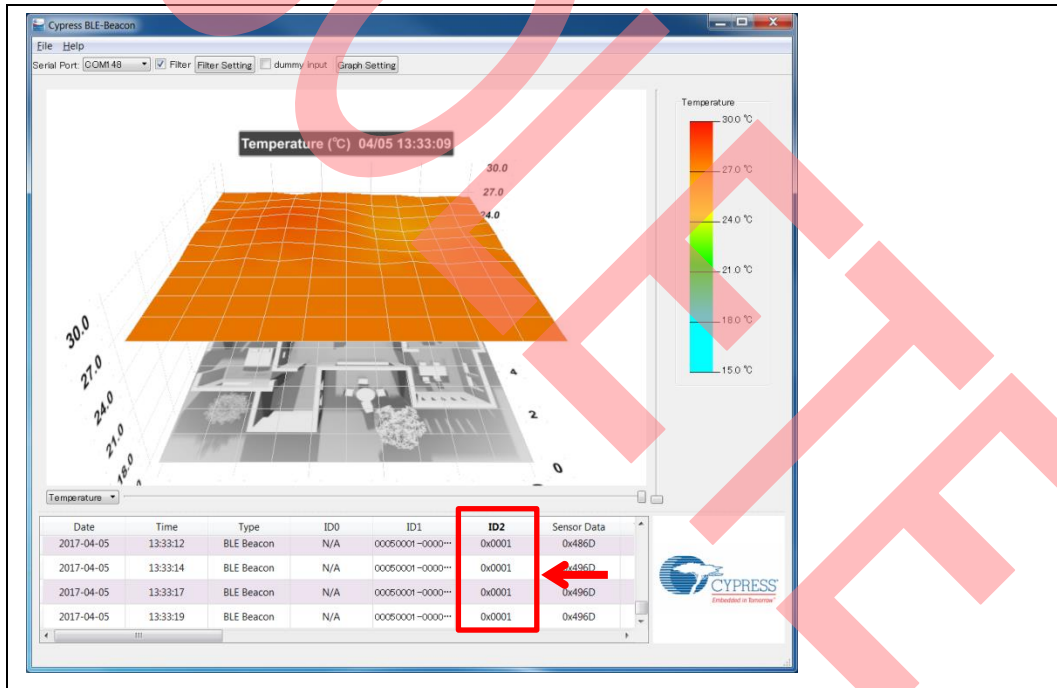
- Plug the Debug Board into your computer's USB port.
- Run *CypressBLE-Beacon.exe*, which is in the Windows application used to view the data received from the Solar BLE Sensor. It is located in the Software folder that you installed earlier:

*<Install directory>\Cypress BLE-Beacon\EXE*

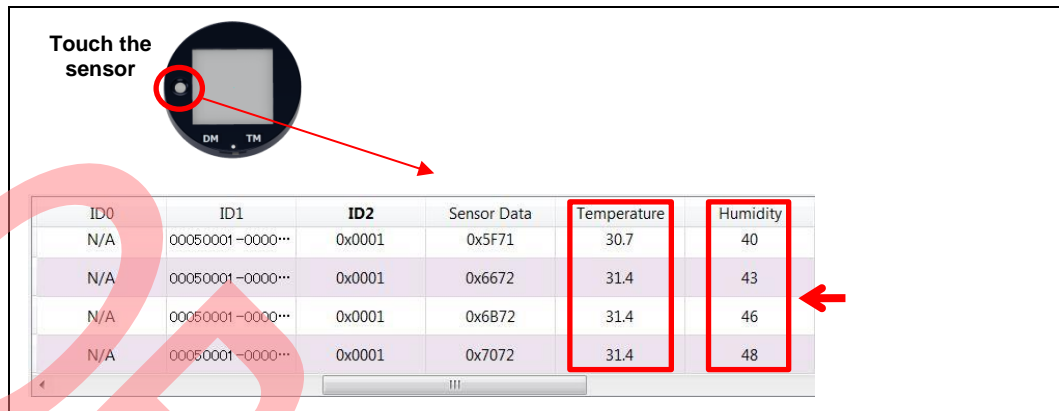
A Cypress BLE-Beacon window will appear. Select COMxx in the **Serial Port** drop-down menu, where COMxx corresponds to the port that was confirmed in step 5 of [3.1.1 USB Driver Installation of Debug Board](#).



- Find the **ID2** number (initial value is 0x0001) of the Solar BLE Sensor in the Cypress BLE-Beacon software. Refer to [3.3 Configuring Solar BLE Sensor](#) to change the **ID2** number.



- Confirm that the WSN is operating by placing your finger on the sensor on the Solar BLE Sensor. Placing your finger raises the temperature and humidity from the indoor environment condition. You should see a corresponding change in temperature or humidity on your PC. When touching the board, be careful of static electricity.



Refer to [Cypress BLE-Beacon PC User Guide](#) for detailed information.

## 3.2 WSN Operation with Mobile Device

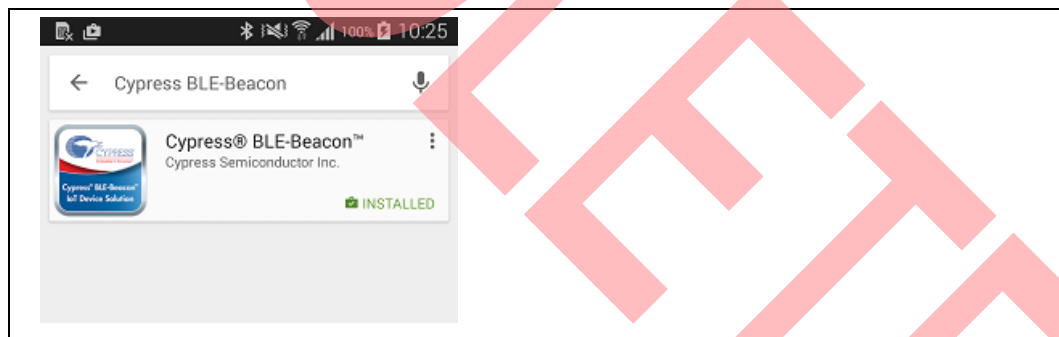
In this section, you will confirm that the Solar BLE Sensor is operating as a WSN by using the apps on your mobile device to detect temperature and humidity changes.

### 3.2.1 Mobile Apps Installation

The Cypress BLE-Beacon app is available on Google Play and in the Apple Store for free. To install the app, follow these instructions.

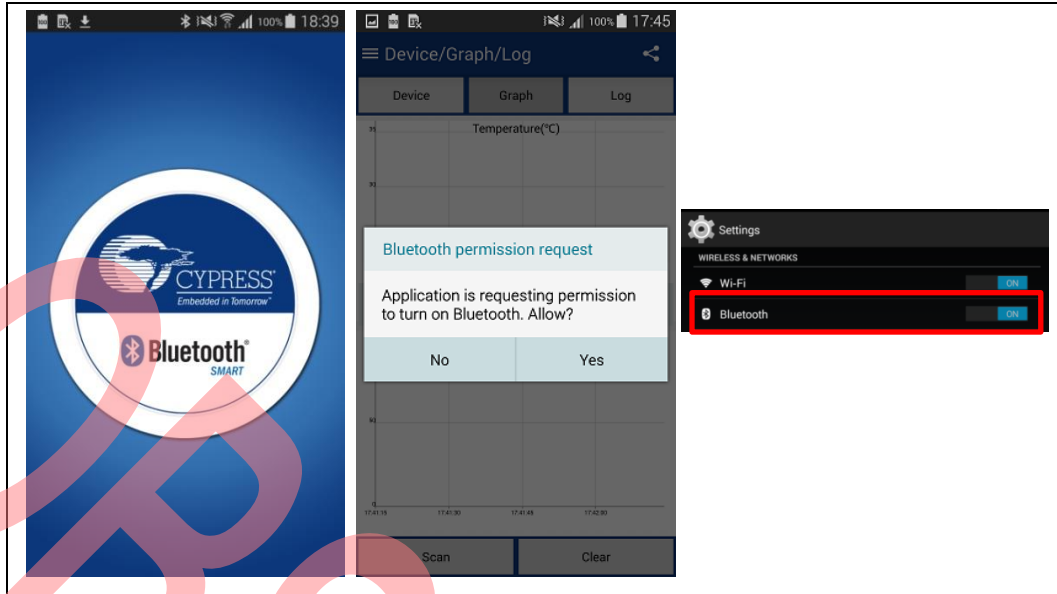
#### 3.2.1.1 Installing the Android App

- Open Google Play and search for "Cypress BLE-Beacon".

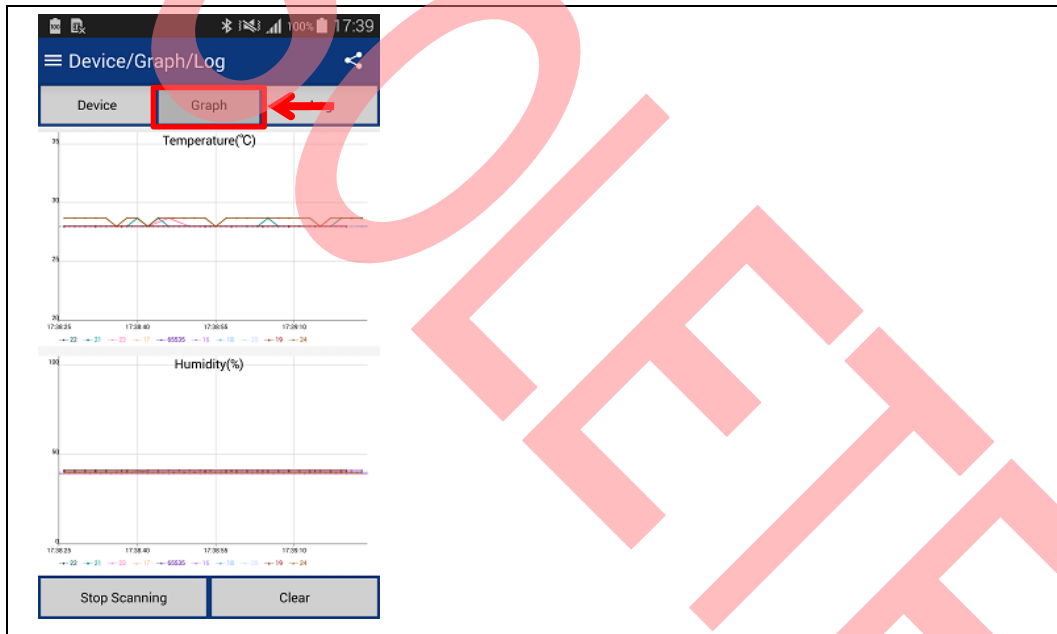


- Select the Cypress BLE-Beacon (BLE-Beacon) app. On the subsequent screen, click the **Install** button to proceed with installation.
- When presented with the app permission dialog, click **Accept** to continue.
- When the installation is complete, the BLE-Beacon app can be launched from the App Drawer.
- Place the Solar BLE Sensor under an office light. Refer to step 2 of [3.1.3 Establishing BLE Connection](#).
- Launch the BLE-Beacon app. A splash screen is displayed for a few seconds before the app displays the **Device List** screen. If Bluetooth is turned OFF in the Android device, Android OS will prompt you to turn ON Bluetooth.





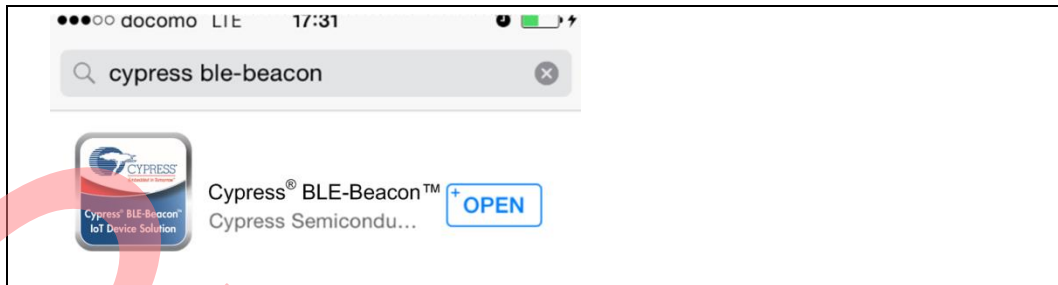
- The BLE-Beacon app performs device discovery by default when the app is opened. Select the mode as Graph to display the sensor data.



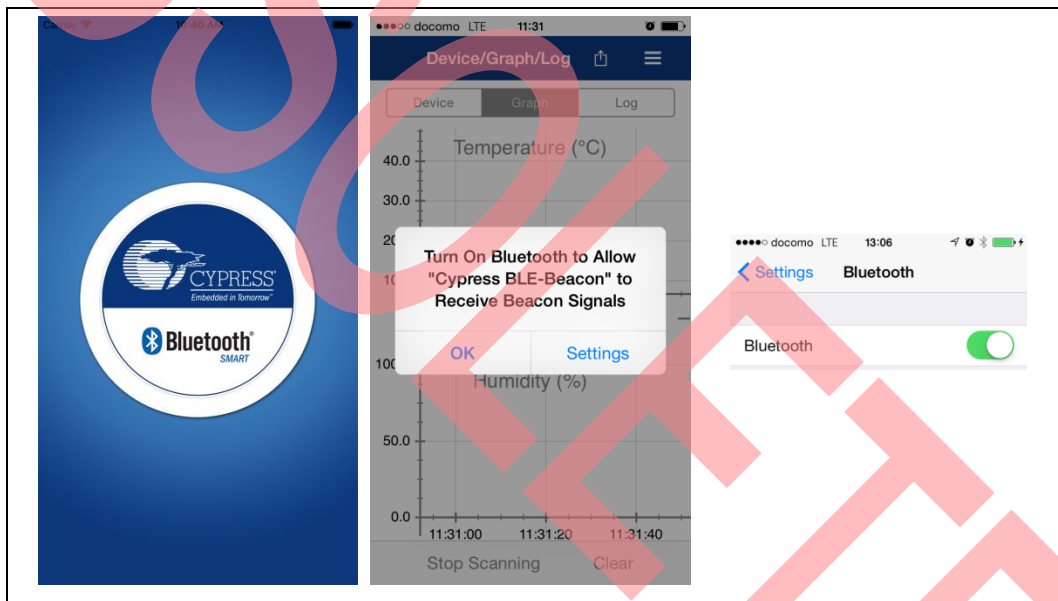
Refer to [Cypress BLE-Beacon Android App User Guide](#) for detailed information.

### 3.2.1.2 Installing the iOS App

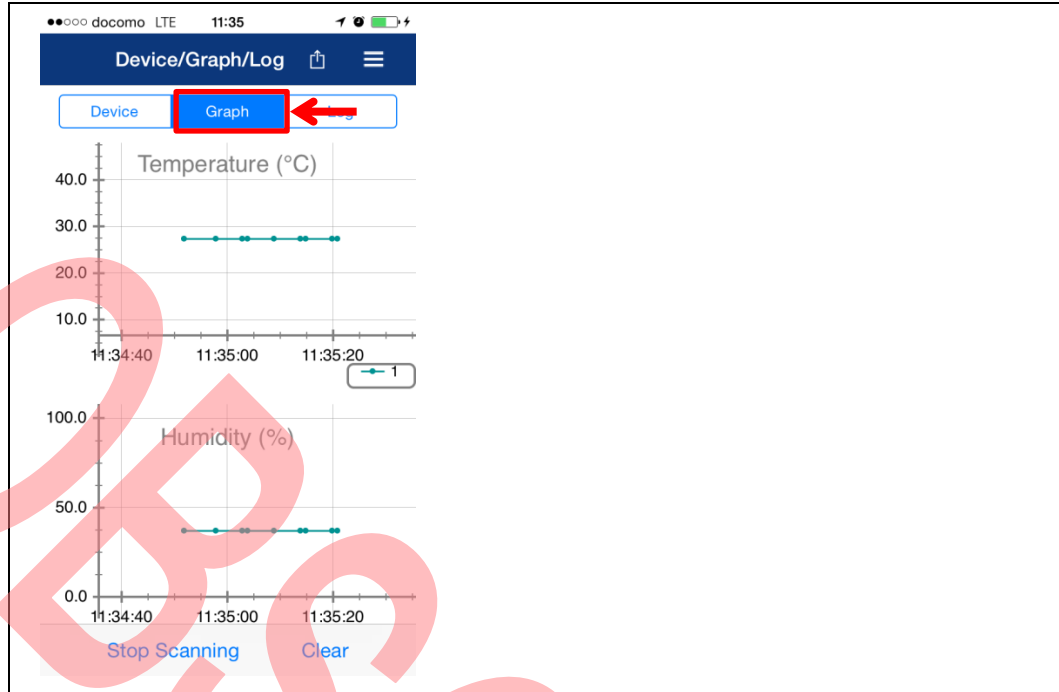
1. Open the App Store and search for “Cypress BLE-Beacon.”



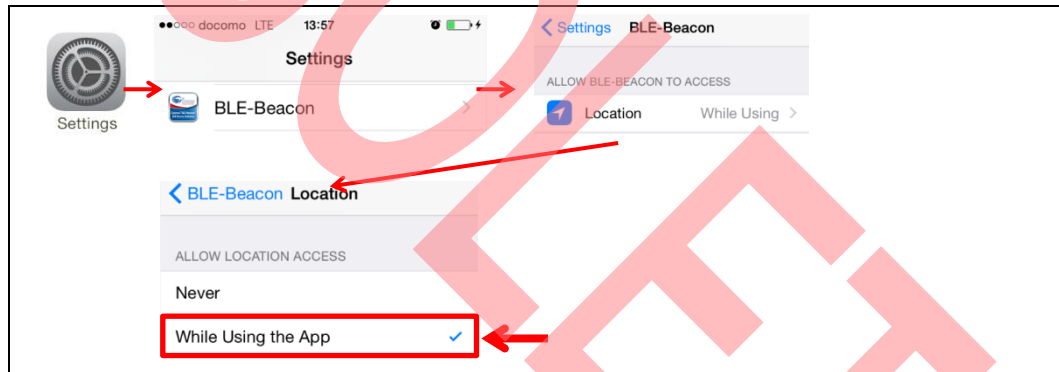
2. Select the Cypress BLE-Beacon (BLE-Beacon) app, and proceed to install the app on your iOS device.
3. Place the Solar BLE Sensor under an office light. Refer to step 2 of 3.1.3 [Establishing BLE Connection](#).
4. Launch the BLE-Beacon app. A splash screen is displayed for a few seconds before the app displays the **Device List** screen. If Bluetooth is turned OFF in the iOS device, iOS will display a message box to turn ON Bluetooth with the **Settings** and **OK** buttons. Click the **Settings** button to turn ON Bluetooth on the **Settings** screen. Clicking the **OK** button will display the message “Please turn Bluetooth ON,” which requires the standard iOS procedure to turn ON Bluetooth.



5. The BLE-Beacon app performs device discovery by default when the app is opened. Select the mode as **Graph** to display the sensor data.



Note that if the sensor data has not appeared on the BLE-Beacon of iOS, you need to confirm that the **Location** setting is set to **While Using the App** (iOS: Home screen > Settings > BLE-Beacon > Location).



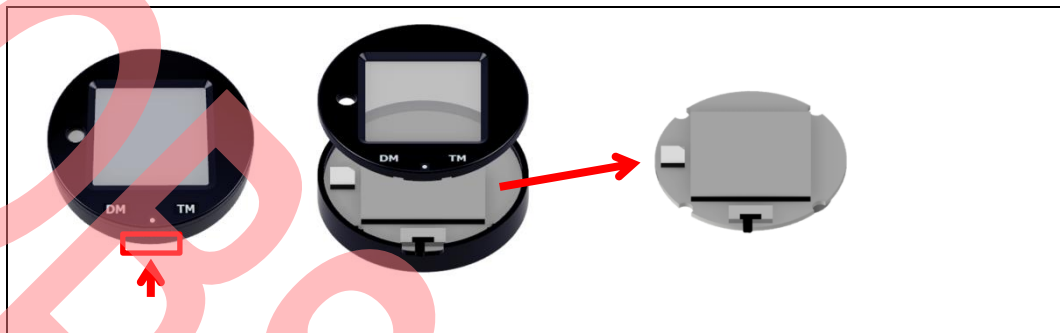
Refer to [Cypress BLE-Beacon iOS App User Guide](#) for detailed information.

### 3.3 Configuring Solar BLE Sensor

In this section, you will configure a parameter of the Solar BLE Sensor according to preprogrammed firmware for this kit. You will do so using a serial USB connection from your PC to send configuration commands to the Solar BLE Sensor.

#### 3.3.1 Connect Solar BLE Sensor to PC

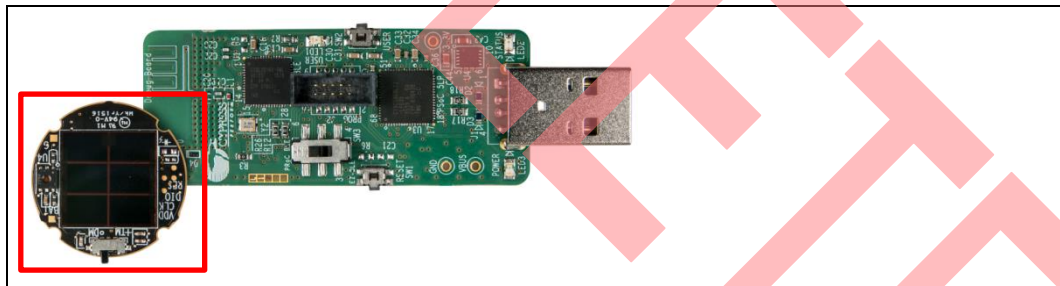
1. Open the enclosure of Solar BLE Sensor using the sharp end of something like tweezers (not included in the kit), and take out the Solar BLE Sensor Board. Refer to [B.2 How to Install the Board in the Enclosure](#) for how to install the board in the enclosure.



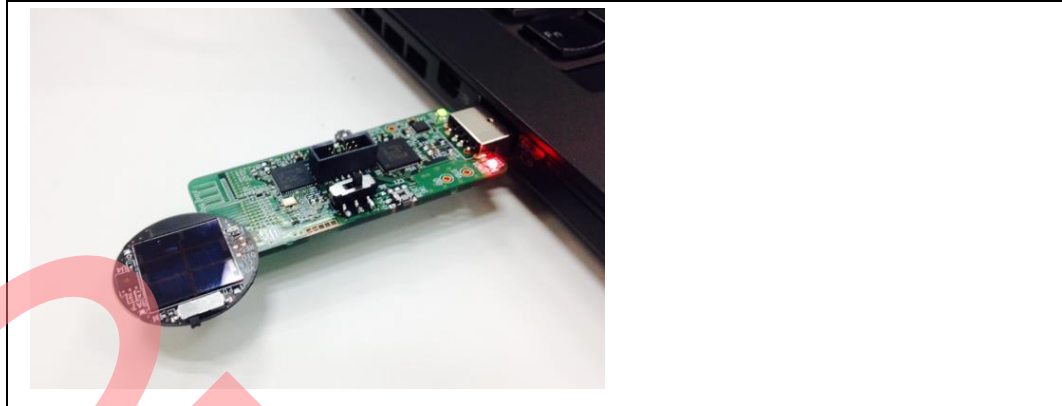
2. Set the slide switch (SW3) on the Debug Board to the EZ-BLE side. Refer to section [Slide Switch for Target Device Select](#) for detailed information on each mode.



3. Connect the Solar BLE Sensor to CN1 of the Debug Board.



4. Plug the Debug Board with the Solar BLE Sensor into your computer's USB port. A supercapacitor (SC1) on the Solar BLE Sensor is charged when the Solar BLE Sensor is connected to the Debug Board via USB. Refer to [Charging the Supercapacitor](#) for detailed information.



### 3.3.2 Configuring Solar BLE Sensor

1. Confirm that a COM port (KitProg USB-UART) was added in the **Device Manager** (refer to step 5 of 3.1.1 [USB Driver Installation of Debug Board](#) for detailed information):

Open the **Device Manager**.

Under **Ports (COM & LPT)**, confirm that a KitProg USB-UART was added. Note the COM number (COMxxx).

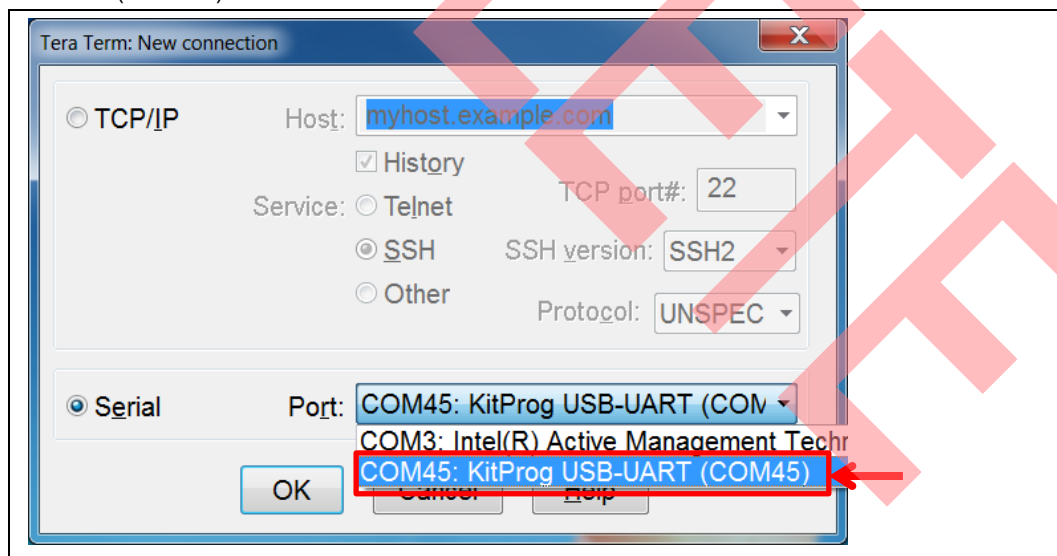
2. Install Tera Term from the following location:

`<Install directory>\Cypress BLE-Beacon\teraterm`

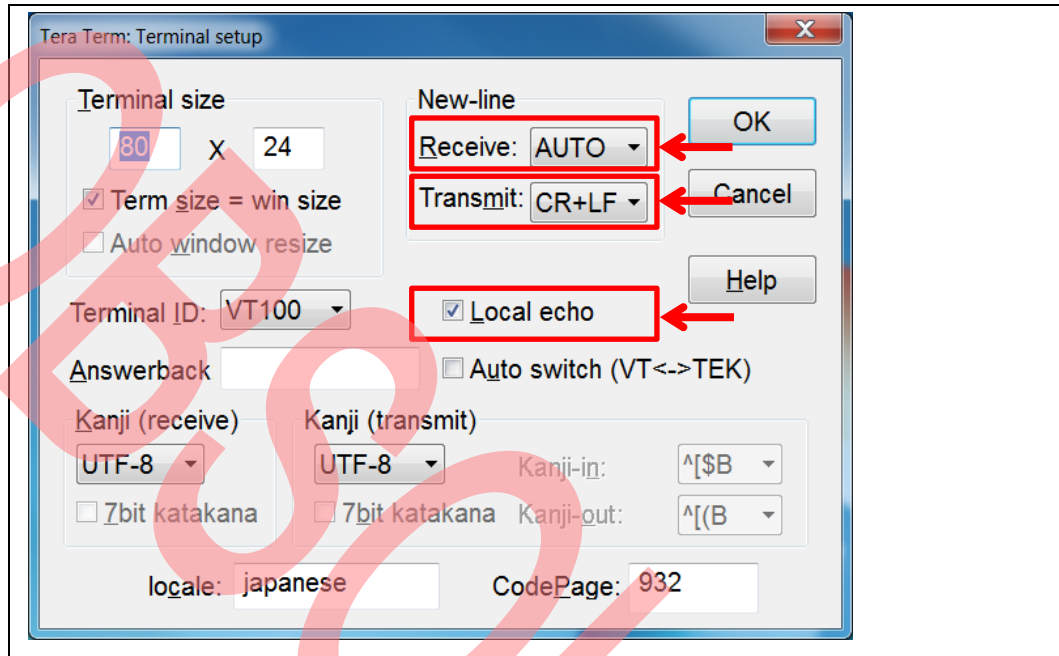
3. After it is installed, run Tera Term:

- Windows 7: **Start > All Programs > Tera Term**
- Windows 8/8.1: **[Ctrl] [Tab] > All Apps > Tera Term**
- Windows 10: **Start button > All Apps > Tera Term**

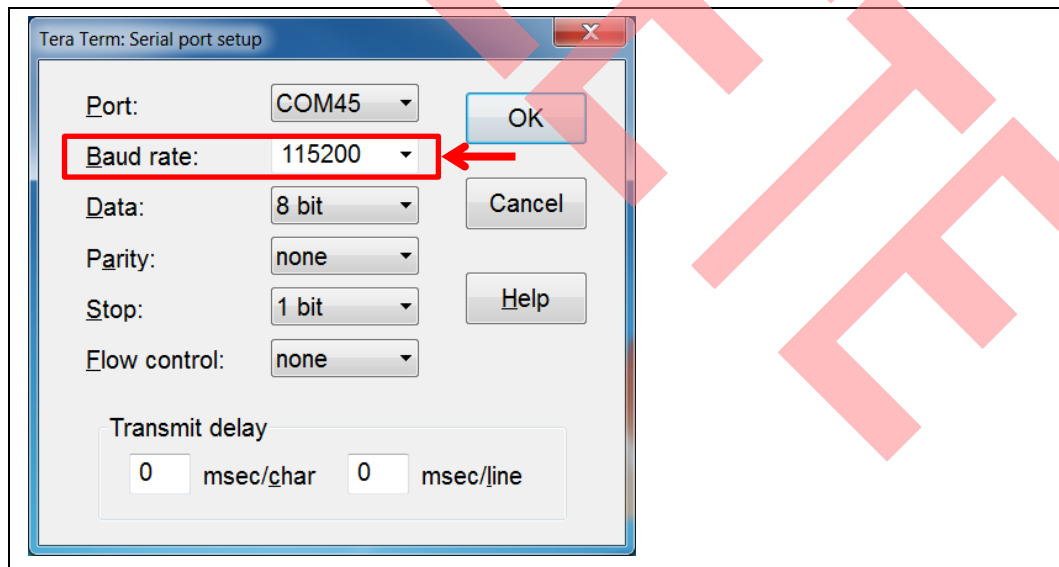
4. In Tera Term, select **File > New Connection**. On the New Connection window, click **Serial** and select “COMxxx: KitProg USB-UART (COMxxx).” Then click **OK**.



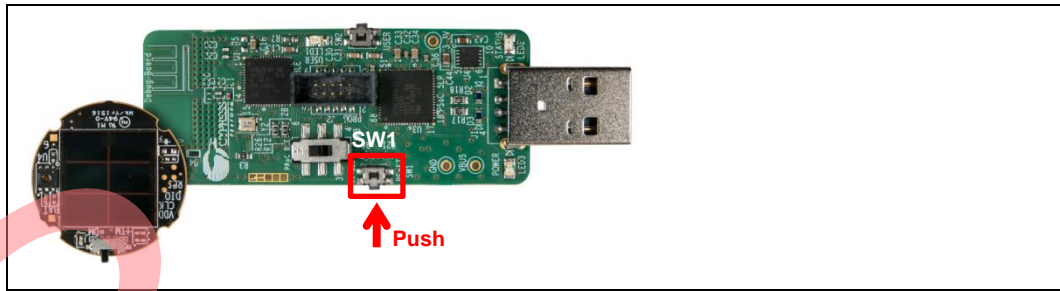
5. Configure the terminal setting (**Setup > Terminal**) as follows. Then click **OK**.
  - Receive: AUTO**
  - Transmit: CR+LF**
  - Local echo: Select**
  - Other settings: Default



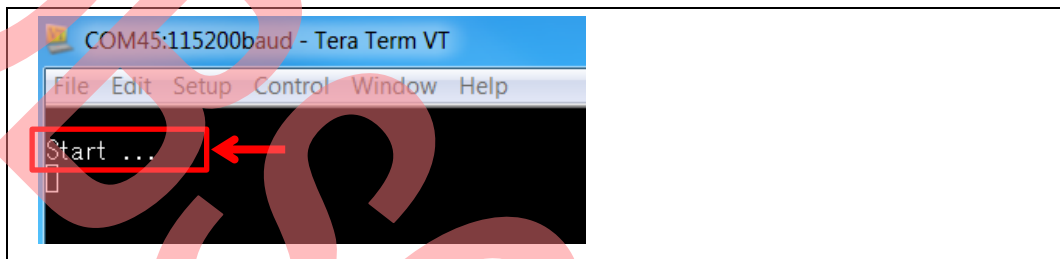
6. Configure the serial port setting (**Setup > Serial Port**) as follows. Then click **OK**.
  - Baud rate: 115200**
  - Other settings: Default



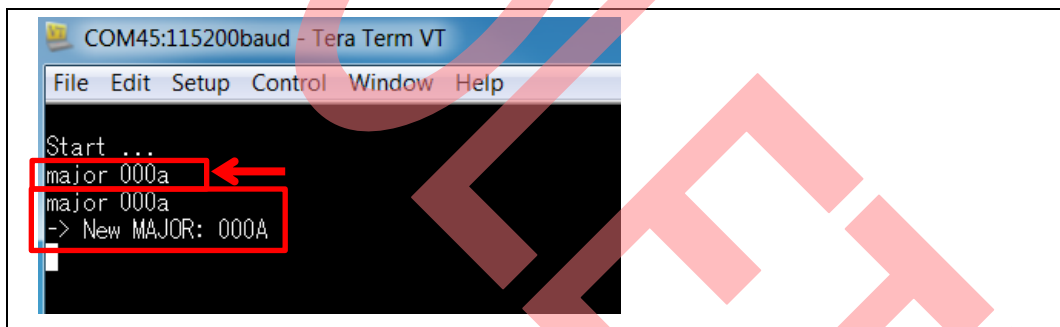
7. Push and release the RESET button (SW1) on the Debug Board. Note that when the Solar BLE Sensor is in this mode, it stops transmitting BLE sensor data.



8. Confirm that the Solar BLE Sensor is in the command mode by observing that the “Start...” message appears on Tera Term. Your board is ready to receive commands.

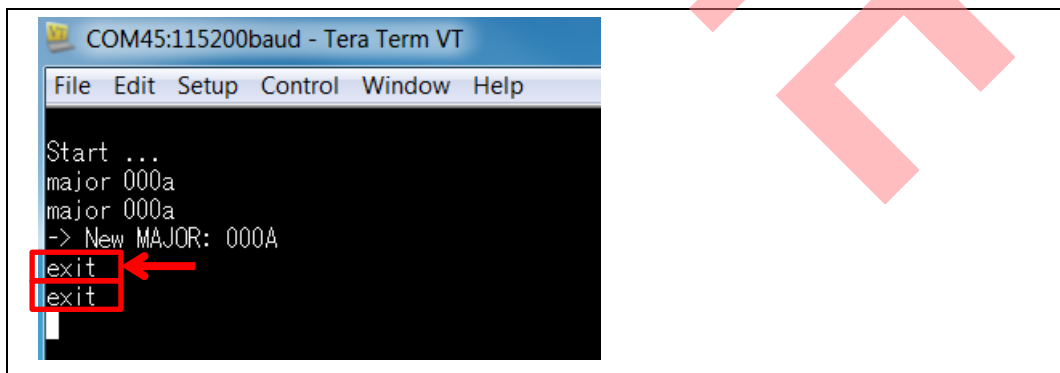


9. For example, this step will set the Major ID to “0x000a” (Hexadecimal) to receive another Solar BLE Sensor ID. On Tera Term, type *major 000A*. The Solar BLE Sensor responds with a confirmation message as follows. Refer to section 3.4 [Serial Command List](#) for a list of all kit commands.

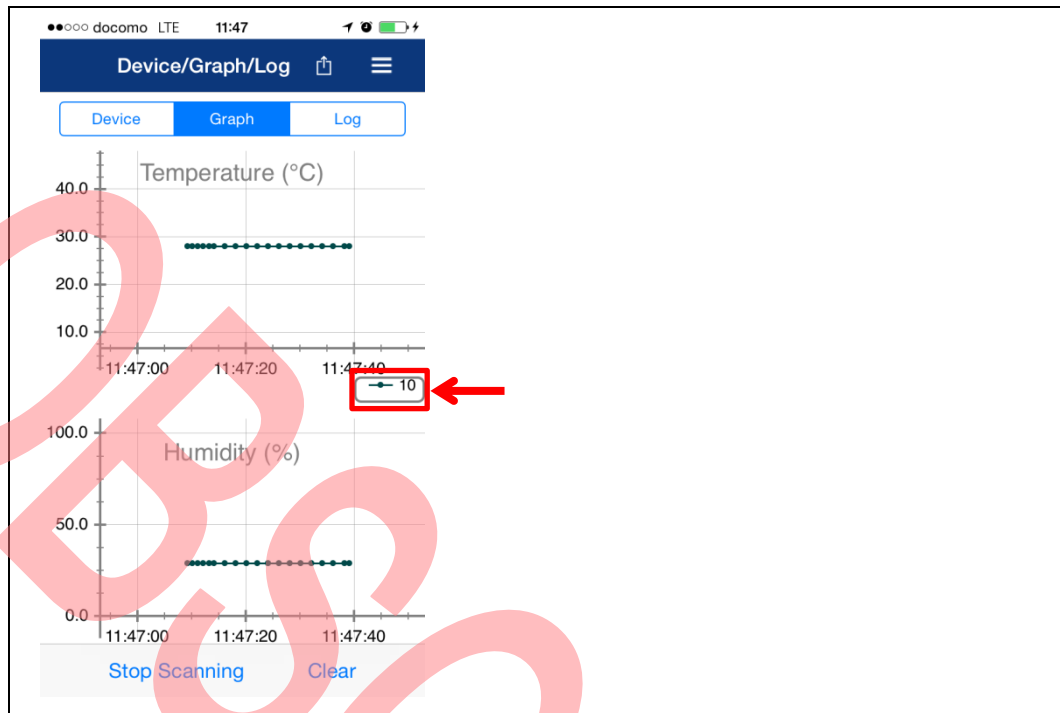


10. To confirm the operation of the changed parameter when using USB bus power, type *exit*. The board will acknowledge the command by responding with “exit.”

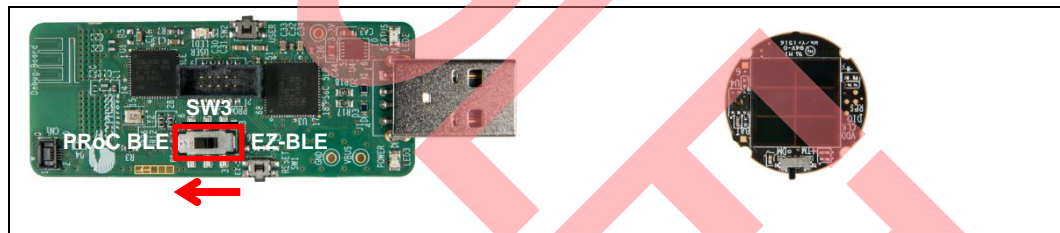
If you do not need to confirm the operation when using USB bus power, skip this step and the next one (step11).



11. You can recognize the changed *MAJOR value 10* (Decimal) on apps when using USB bus power (initial time interval is 1.5 s when using USB bus power).



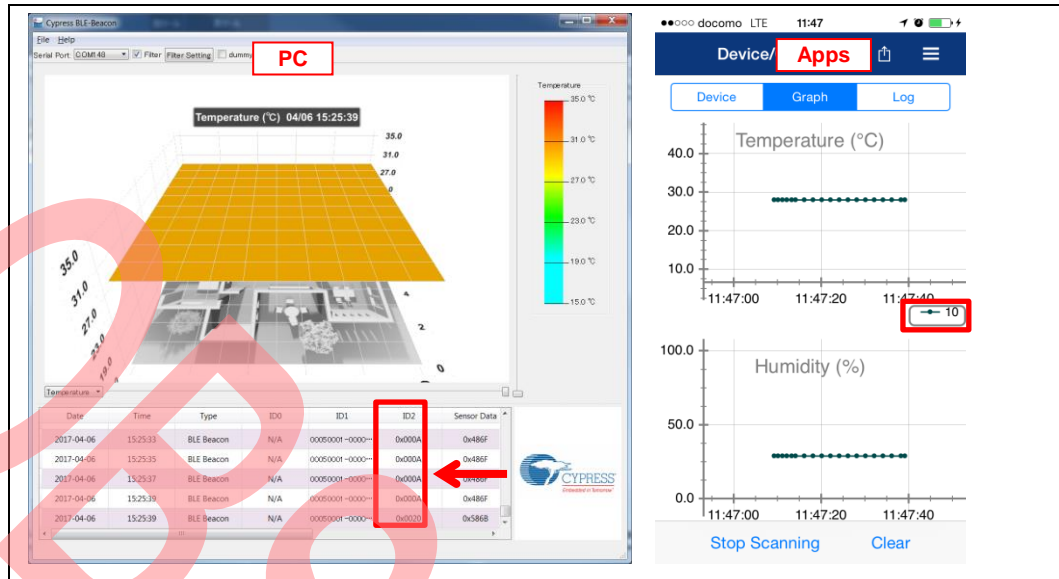
12. Disconnect the Debug Board from the PC and then disconnect the Solar BLE Sensor from the Debug Board. Set the slide switch (SW3) on the Debug Board to the ProC BLE side to receive the sensor data.



13. Plug the Debug Board into your computer's USB port again.



- Confirm the changed MAJOR value 0x000A via PC (Refer to 3.1 WSN Operation with PC) or apps (Refer to 3.2 WSN Operation with Mobile Device) by energy harvesting operation.



Refer to Table 3-1 for the time interval of the energy harvesting operation.

### 3.4 Serial Command List

Table 3-2 lists the serial commands that can be used to control the kit from your computer using the USB serial interface. Refer to the 3.3 Configuring Solar BLE Sensor section for instructions on how to issue these commands via the USB serial interface. The commands are not case-sensitive.

Note that the following commands are for CYALKIT-E02 Sample Firmware, Version 1.2.00. Refer to 4.2 Programming and Debugging section for instructions on how to program the firmware.

Table 3-2. Command List

No.	Command Name	Command Use	Description	Default
[1]	UUID	For BLE Beacon Mode	Read/Write of UUID <sup>1</sup>	00050001-0000-1000-8000-00805F9B0131 [hex]
[2]	MAJOR		Read/Write of MAJOR <sup>1</sup>	0x0001
[3]	TXPWR		Read/Write the Transmitter Power Strength in BLE Beacon mode	3 dBm
[4]	RSSI		Read/Write of Received Power Strength for distance 1m (RSSI)	-61 dBm
[5]	COID		Read/Write of Bluetooth Company	0x004C
[6]	EDNID	For Eddystone Mode	Read/Write NID	CB6F15CEC02A41F76AB1 [hex]
[7]	EDBID		Read/Write BID	000000010001 [hex]
[8]	EDTXPWR		Read/Write the Transmitter Power Levels in Eddystone mode	-18 -12 0 3 dBm
[9]	EDFRAME		Read/Write Eddystone Frame Advertisement Flags	uid on, url off, tlm on
[10]	EDSTATE		Read the Lock State	Unlocked
[11]	EDLOCK		Lock Eddystone-URL Configuration Service and set the lock-code	00000000-0000-0000-0000-000000000000 [hex]
[12]	EDUNLOCK		Unlock Eddystone-URL Configuration Service	-
[13]	EDURI	Read/Write the URL	<a href="http://www.cypress.com/">http://www.cypress.com/</a>	

No.	Command Name	Command Use	Description	Default
[14]	EDADPWR	For Both Modes	Read/Write the Received Power Levels at 0 meters(RSSI)	-41 -35 -23 -20 dBm
[15]	EDTXMODE		Read/Write TX Power Mode	HIGH
[16]	EDITRVL		Read/Write the Advertise Interval in Eddystone mode	100 ms (Note: when this value is 0, and MODE is Eddystone, there's no advertisement.)
[17]	EDRESET		Set Eddystone parameters to their initial values except EDNID, EDBID and EDFRAME.	-
[18]	MODE		Read/Write mode	BLE Beacon
[19]	INIT		Default all parameters	-
[20]	EXIT		Exit the UART command waiting mode and Eddystone-URL Configuration Service, then start BLE advertisements	-
[21]	VER		Display Firmware Version	-
[22]	HELP		Display Command List	-

<sup>1</sup> Refer to [BLE Beacon Format](#) for detailed information.

[1] Read/Write of UUID

[1-1] Read

Read UUID data. Default: 00050001-0000-1000-8000-00805F9B0131

<Example>

UUID↵

(echo) UUID

(output) -> UUID: 00050001-0000-1000-8000-00805F9B0131

[1-2] Write

Write UUID data.

<Example>

UUID EEEEDDDD-CCCC-BBBB-AAAA-999988887777↵

(echo) UUID EEEEDDDD-CCCC-BBBB-AAAA-999988887777

(output) -> New UUID: EEEEDDDD-CCCC-BBBB-AAAA-999988887777

[2] Read/Write of MAJOR

[2-1] Read

Read MAJOR. Default: 0x0001

<Example>

MAJOR↵

(echo) MAJOR

(output) -> MAJOR: 0001

## [2-2] Write

Write MAJOR.

&lt;Example&gt;

MAJOR 1A2F ↵ &lt;- Input HEX data

(echo) MAJOR 1A2F

(output) -&gt; New MAJOR: 1A2F

## [3] Read/Write of Transmitter Power Strength

## [3-1] Read

Read Power Strength. Default: 3 dBm

&lt;Example&gt;

TXPWR ↵

(echo) TXPWR

(output) -&gt; TX power in dBm: 3

## [3-2] Write

Set Power Strength. Set Value: -18, -12, -6, -3, -2, -1, 0, 3

&lt;Example&gt;

TXPWR -18 ↵

(echo) TXPWR -18

(output) -&gt; New TX power in dBm: -18

## [4] Read/Write of Receiver Power Strength for distance 1m (RSSI)

## [4-1] Read

Read RSSI. Default: -61dBm

&lt;Example&gt;

RSSI ↵

(echo) RSSI

(output) -&gt; RSSI in dBm: -61

## [4-2] Write

Set RSSI.

&lt;Example&gt;

RSSI -90 ↵

(echo) RSSI -90

(output) -&gt; New RSSI in dBm: -90

## [5] Read/Write of Bluetooth Company

## [5-1] Read

Read Bluetooth Company. Default: 0x004C

<Example>

COID↵

(echo) COID

(output) -> Company ID: 004C

[5-2] Write

Write Bluetooth Company.

<Example>

COID 0059↵

<- Input HEX data

(echo) COID 0059

(output) -> New Company ID: 0059

[6] Read/Write NID

[6-1] Read

Read NID data. Default: CB6F15CEC02A41F76AB1

<Example>

EDNID↵

(echo) EDNID

(output) -> Eddystone-UID NID : CB6F15CEC02A41F76AB1

[6-2] Write

Write NID data.

<Example>

EDNID 00010203040506070809↵ <- Input HEX data

(echo) EDNID 00010203040506070809

(output) -> New Eddystone-UID NID : 00010203040506070809

[7] Read/Write BID

[7-1] Read

Read BID data. Default: 000000010001

<Example>

EDBID↵

(echo) EDBID

(output) -> Eddystone-UID BID : 000000010001

[7-2] Write

Write BID data

<Example>

```
EDBID 0A0B0C0D0E0F ↵      <- Input HEX data
(echo) EDBID 0A0B0C0D0E0F
(output) -> New Eddystone-UID BID : 0A0B0C0D0E0F
```

#### [8] Read/Write the Transmitter Power Levels in Eddystone mode

##### [8-1] Read

Read Power Strength levels.      Default: -18 -12 0 3 dBm

The four Levels correspond to TX\_POWER\_MODE\_LOWEST, TX\_POWER\_MODE\_LOW, TX\_POWER\_MODE\_MEDIUM, TX\_POWER\_MODE\_HIGH.

<Example>

```
EDTXPWR ↵
```

```
(echo) EDTXPWR
```

```
(output) -> Eddystone Radio TX Power Levels : -18 -12 0 3
```

##### [8-2] Write

Set Power Strength levels.      Set Value: -18, -12, -6, -3, -2, -1, 0, 3

Writing is not allowed if Eddystone-URL Configuration Service is locked. The four Levels correspond to TX\_POWER\_MODE\_LOWEST, TX\_POWER\_MODE\_LOW,

TX\_POWER\_MODE\_MEDIUM, TX\_POWER\_MODE\_HIGH.

<Example>

```
EDTXPWR -6 -3 -2 -1 ↵
```

```
(echo) EDTXPWR -6 -3 -2 -1
```

```
(output) -> New Eddystone Radio TX Power Levels : -6 -3 -2 -1
```

#### [9] Read/Write Eddystone Frame Advertisement Flags

##### [9-1] Read

Read Frame Flags.      Default: uid on, url off, tlm on

<Example>

```
EDFRAME ↵
```

```
(echo) EDFRAME
```

```
(output) -> EDFrame mode : uid on, url off, tlm on
```

##### [9-2] Write

Set Frame Flags.

<Example>

```
EDFRAME uid url ↵      Set Value: uid, url, tlm
```

```
(echo) EDFRAME uid url
```

```
(output) -> New EDFrame mode : uid on, url on, tlm off
```

### [10] Read the Lock State

Read the lock state. Default: unlocked

<Example>

EDSTATE↵

(echo) EDSTATE

(output) -> EDSTATE: unlocked

### [11] Lock Eddystone-URL Configuration Service and set the lock-code

Write new lock-code and lock Eddystone-URL Configuration Service. This write operation is not allowed if Eddystone-URL Configuration Service is locked.

<Example>

EDLOCK EEEEDDDD-CCCC-BBBB-AAAA-999988887777↵

(echo) EDLOCK EEEEDDDD-CCCC-BBBB-AAAA-999988887777

(output) -> New EDSTATE: locked

### [12] Unlock Eddystone-URL Configuration Service

Unlock Eddystone-URL Configuration Service with lock-code set by EDLOCK command. If user forgets the code, user needs send the DEFAULT command to change the lock state to unlocked.

<Example>

EDUNLOCK EEEEDDDD-CCCC-BBBB-AAAA-999988887777↵

(echo) EDUNLOCK EEEEDDDD-CCCC-BBBB-AAAA-999988887777

(output) -> New EDSTATE: unlocked

### [13] Read/Write the URL

#### [13-1] Read

Read the URL. Default: <http://www.cypress.com/>

<Example>

EDURI↵

(echo) EDURI

(output) -> Eddystone-URL URI Data: <http://www.cypress.com/>

#### [13-2] Write

Write the URL. This write operation is not allowed if Eddystone-URL Configuration Service is locked.

The length is limited. The URL is case-sensitive except the protocol ([http](http://) or [https](https://)) and the domain.

<Example 1>

EDURI <http://www.Abc.com/Root>↵ <- Input [protocol]://[domain]/[path]

(echo) EDURI <http://www.Abc.com/Root>

(output) -> New Eddystone-URL URI Data : <http://www.abc.com/Root>

<Example 2>

EDURI 0061626307 ↵                    <- Input HEX data

(echo) EDURI 0061626307

(output) -> New Eddystone-URL URI Data : 0061626307

[14] Read/Write the Received Power Levels at 0 meters(RSSI)

[14-1] Read

Read RSSI Levels.                    Default: -41 -35 -23 -20 dBm

The four levels correspond to TX\_POWER\_MODE\_LOWEST, TX\_POWER\_MODE\_LOW, TX\_POWER\_MODE\_MEDIUM, TX\_POWER\_MODE\_HIGH.

<Example>

EDADPWR ↵

(echo) EDADPWR

(output) -> Eddystone Advertised TX Power Levels : -41 -35 -23 -20

[14-2] Write

Set RSSI Levels.                    Set Value: -100~20 dBm

This operation is not allowed if Eddystone-URL Configuration Service is locked. The four levels correspond to TX\_POWER\_MODE\_LOWEST, TX\_POWER\_MODE\_LOW,

TX\_POWER\_MODE\_MEDIUM, TX\_POWER\_MODE\_HIGH.

<Example>

EDADPWR -100 -50 0 20 ↵

(echo) EDADPWR -100 -50 0 20

(output) -> New Eddystone Advertised TX Power Levels : -100 -50 0 20

[15] Read/Write TX Power Mode

[15-1] Read

Read TX Power Mode.                    Default: HIGH

<Example>

EDTXMODE ↵

(echo) EDTXMODE

(output) -> Eddystone TX Power Mode : HIGH

[15-2] Write

Set TX Power Mode.                    Set Value: LOWEST, LOW, MEDIUM, HIGH

This write operation is not allowed if Eddystone-URL Configuration Service is locked.

<Example>

EDTXMODE LOW ↵

(echo) EDTXMODE LOW

(output) -> New Eddystone TX Power Mode : LOW

[16] Read/Write the Advertise Interval in Eddystone mode

[16-1] Read

Read Advertise Interval. Default: 1000ms

<Example>

EDITRVL↵

(echo) EDITRVL

(output) -> Eddystone advertise Interval in msec: 1000

[16-2] Write

Set Advertise Interval. Set Value: 0, 100~10240 ms

This operation is not allowed if Eddystone-URL Configuration Service is locked.

<Example>

EDITRVL 10240↵

(echo) EDITRVL 10240

(output) -> New Eddystone Advertise Interval in msec: 10240

[17] EDRESET

Set Eddystone parameters to their initial values except EDNID, EDBID and EDFRAME.

This operation is not allowed if Eddystone-URL Configuration Service is locked.

<Example>

EDRESET ↵

(echo) EDRESET

(output) -> Reset finished!

[18] Read/Write the mode

[18-1] Read

Read the mode setting Default: BLEBeacon

<Example>

MODE↵

(echo) MODE

(output) -> Mode : BLEBeacon

[18-2] Write

Change the mode setting set value: BLEBeacon, Eddystone, EDTest

<Example>

MODE Eddystone↵

(echo) MODE Eddystone

(output) -> New mode : Eddystone



**[19] INIT**

Change all the settings to their default values.

<Example>

INIT↵

(echo) INIT

(output) -> Restore to default!

**[20] EXIT**

Exit the UART command waiting mode and Eddystone-URL Configuration Service, then start BLE advertisements.

<Example>

EXIT↵

(echo) EXIT

(output)

**[21] VER**

Display Firmware Version.

<Example>

VER↵

(echo) VER

(output) -> CYALKIT-E02 Sample Firmware, Version 1.2.00

**[22] HELP**

Display Command List.

<Example>

HELP↵

(echo) HELP

(output) Get uuid, input:uuid+Enter

(output) Set uuid, input:uuid xxxxxxxx-xxxx-xxxx-xxxx-xxxxxxxxxxxx+Enter

(output) Get major, input:major+Enter

(output) Set major, input:major xxxx+Enter

(output) Get minor, input:minor+Enter

(output) Set minor, input:minor xxxx+Enter

**[\*] Input another command (Error Handling)**

TEST

(echo) TEST

(output) Command format error!!

### 3.5 Eddystone-URL Configuration Service

When the beacon is powered up by USB, it is placed in Configuration Mode after the UART Bootloader boots up the program. The beacon advertises an ADV packet indicating that mode for 60 seconds. A BLE device can connect to it as a GATT client before it stops advertising. The client can read or write the Eddystone-URL Configuration Service Characteristics. The following is the list of the Characteristics. These Characteristics fully comply with descriptions at the following web page: <https://github.com/google/eddystone/blob/master/eddystone-url/docs/config-service-spec.md>.

Table 3-3. Characteristic List

No.	Characteristic Name	Description	Default
[1]	Lock State	Reads the lock state Functions in the same way as the EDSTATE command	false(unlocked)
[2]	Lock	Locks the beacon and sets the single-use lock-code Functions in the same way as the EDLOCK command	00000000-00000-0000-0000-000000000000 [hex]
[3]	Unlock	Unlocks the beacon and clears the single-use lock-code Functions in the same way as the EDUNLOCK command	-
[4]	URI Data	Reads/writes the URL Functions in the same way as the EDURI command	<a href="http://www.cypress.com/">http://www.cypress.com/</a>
[5]	URI Flags	Reads/writes the flags	0
[6]	Advertised Tx Power Levels	Reads/writes the Advertised Power Levels array Functions in the same way as the EDADPWR command	-41 -35 -23 -20 dBm
[7]	Tx Power Mode	Reads/writes the TX Power Mode Functions in the same way as the EDTXMODE command	1 [TX_POWER_MODE_HIGH]
[8]	Beacon Period	The period in milliseconds that Eddystone packets are transmitted Functions in the same way as the EDITRVL command	1000 ms (Note: when this value is 0, and MODE is Eddystone, there's no advertisement.)
[8]	Reset	Sets EDTXPWR and all characteristics to their initial values Functions in the same way as the EDRESET command	-

### 3.6 Note About Validators

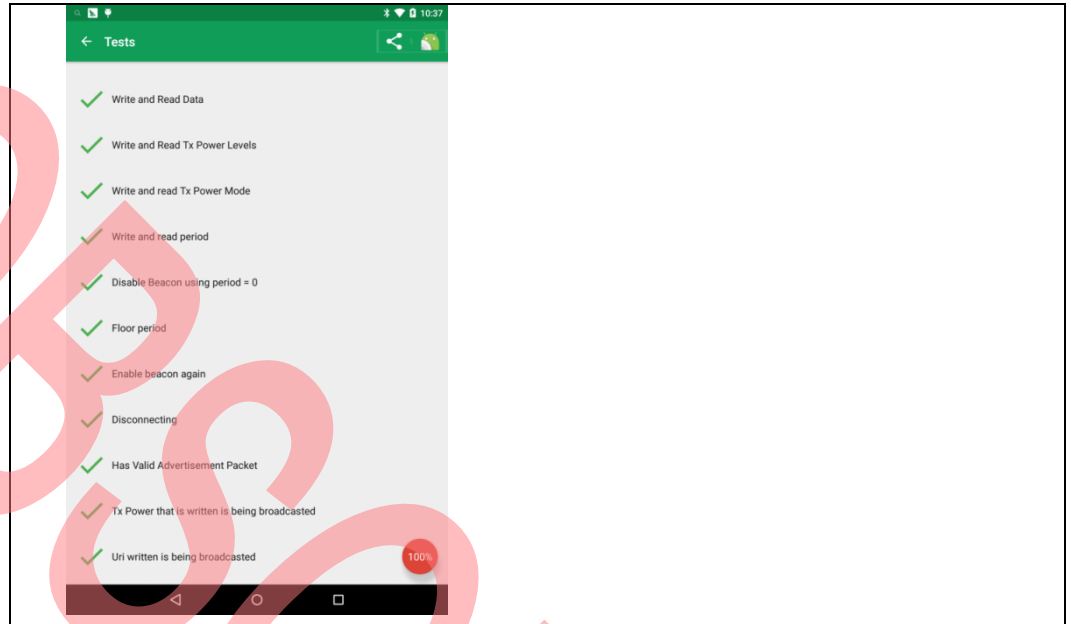
Google offers two Android apps, **eddystone-validator** and **eddystone-url-config-validator**, to assist developers and implementers in working with Eddystone devices. On some occasions, the eddystone-url-config-validator reports errors when validating the beacon with it. This section introduces the cause of the errors and the steps to pass the validation.

Eddystone-url-config-validator validates the Eddystone-URL frame. It takes the Eddystone-UID frame and Eddystone-TLM frame as invalid advertisement packets. It detects Eddystone-UID frame packets immediately after disconnecting itself and the detection time is limited. Therefore, you must change some settings to have the beacon advertise Eddystone-TLM frame only, and send the EXIT command through UART immediately after the validator finishes disconnection.

To facilitate Core Eddystone-URL Tests with eddystone-url-config-validator, a new mode is provided to replace these operations. Ensure that you have set the mode as **EDTest** before starting the tests.

If testing a write characteristic operation fails, try closing all the Bluetooth apps, powering OFF the Android device, and then restarting it.

Core Eddystone-URL Tests are completed.



# 4. Program and Debug



The Solar-Powered BLE Sensor Beacon RDK can be programmed and debugged using KitProg (PsoC 5LP) on the Debug Board. Before debugging the device, ensure that PsoC Creator is installed on the computer.

## 4.1 KitProg

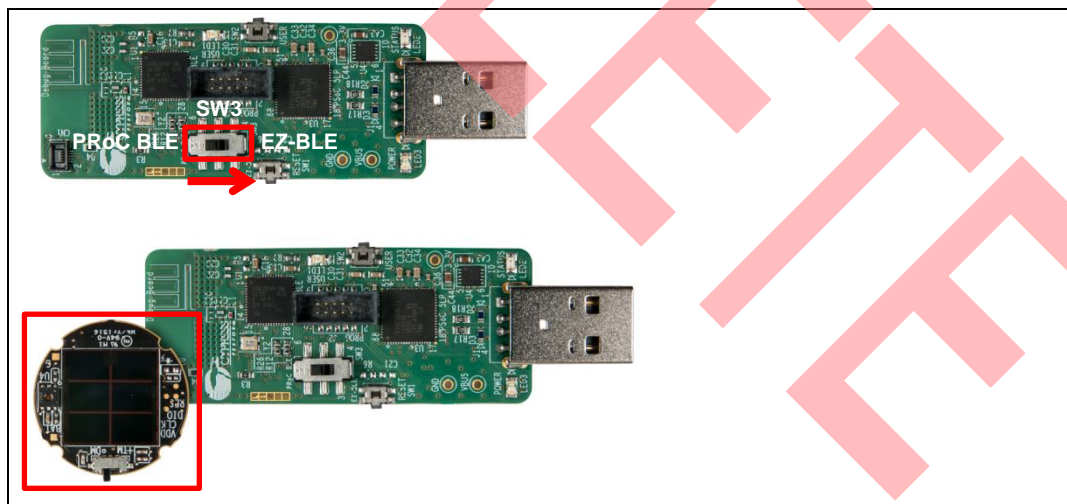
KitProg is the hardware/firmware block for onboard programming, debugging, and bridge functionality. It is a common reusable hardware/firmware block used across many Cypress kit platforms. It consists of a PsoC 5LP device, which connects to the computer over a USB interface and connects to ProC BLE on the Debug Board or EZ-BLE module on the Solar BLE Sensor over SWD, I<sup>2</sup>C, and UART pins. KitProg communicates with PsoC Programmer and PsoC Creator software to program/debug the target ProC BLE or EZ-BLE module over the SWD interface. The main advantage of an onboard programmer/debugger is that users do not have to buy extra programmer/debugger hardware.

## 4.2 Programming and Debugging

### 4.2.1 Initial setup

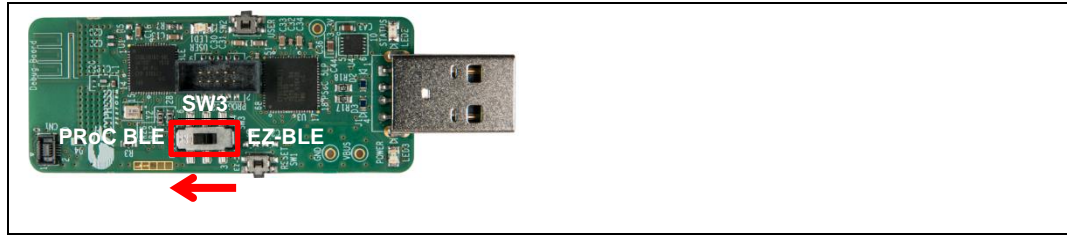
#### 4.2.1.1 Solar BLE Sensor

To program and debug the EZ-BLE module on the Solar BLE Sensor, set the slide switch (SW3) on the Debug Board to the EZ-BLE side. Then connect the Solar BLE Sensor to CN1 of the Debug Board.



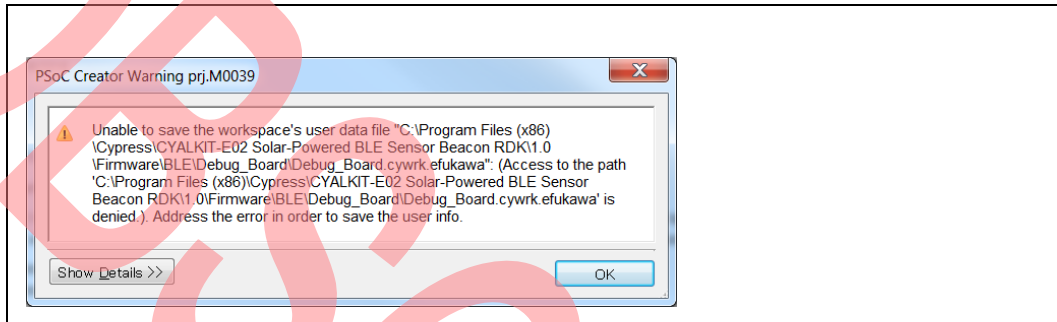
#### 4.2.1.2 Debug Board

To program and debug the ProC BLE on the Debug Board, set the slide switch (SW3) on the Debug Board to the ProC BLE side. Do not connect the Solar BLE Sensor to CN1.



#### 4.2.2 Programming and Debugging Using PsoC Creator

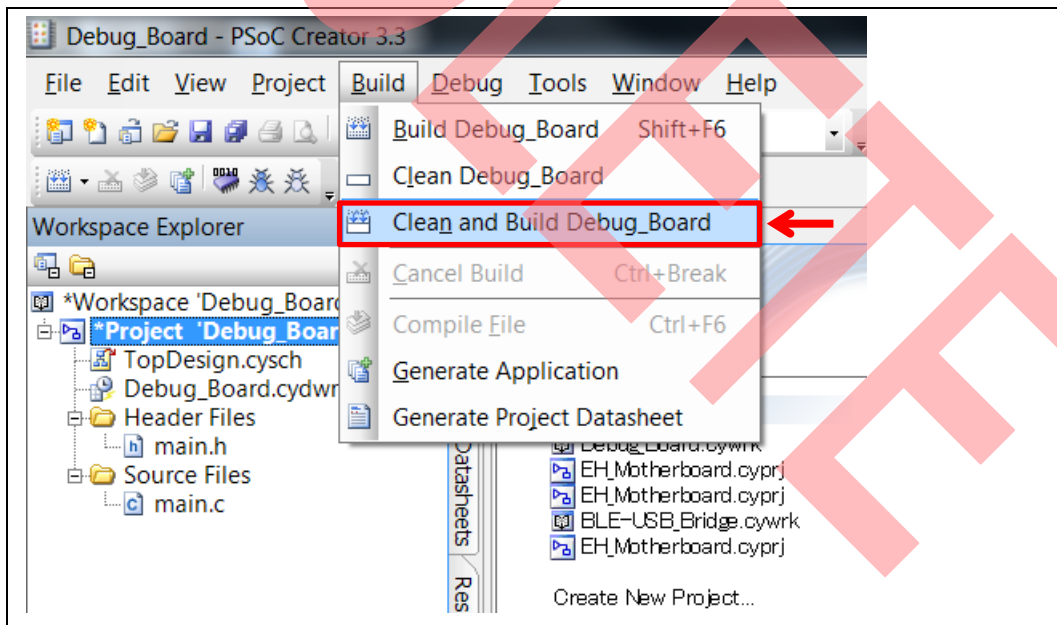
1. Plug the Debug Board into your computer's USB port.
2. If you installed the RDK software to the default location, copy the BLE folder to your local folder. Note that the following warning message appears when the folder is in C:\Program Files or C:\Program Files (x86).



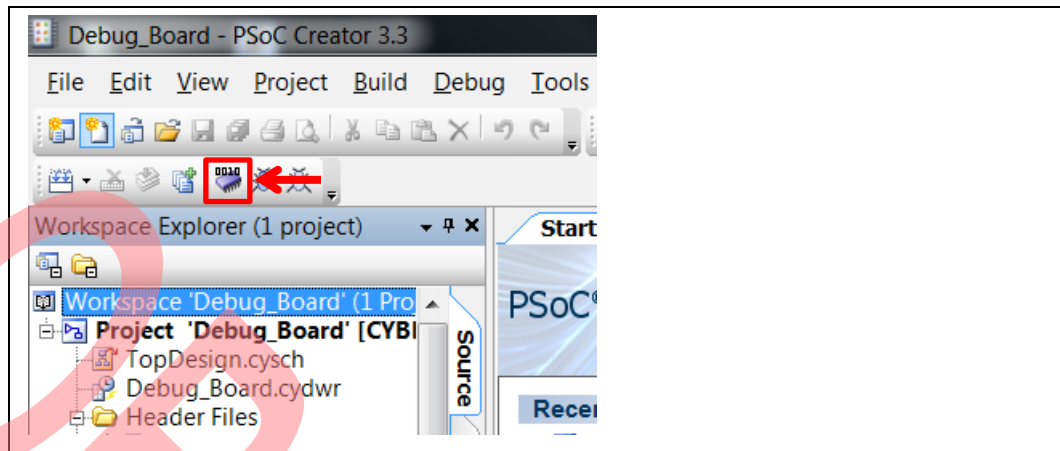
The BLE folder is located in the Firmware folder that you installed earlier:

*<Install directory>\CYALKIT-E02 Solar-Powered BLE Sensor Beacon RDK<version>\Firmware*

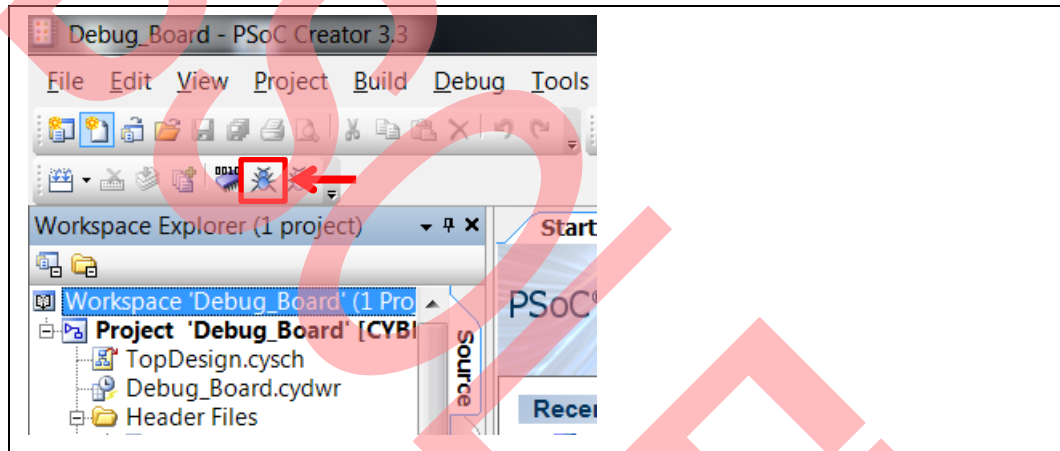
8. Open Solar\_BLE\_Sensor.cywrk or Debug\_Board.cywrk for the example project.
9. Clean and build the project by choosing Build > Clean and Build <Project Name>.



- If there are no errors during build, program the firmware by clicking the **Program** button on the toolbar or pressing [Ctrl] [F5], as follows. This will program EZ-BLE or ProC BLE so it will be ready for use.



- To debug the device, click the **Debug** icon or press [F5], as follows.



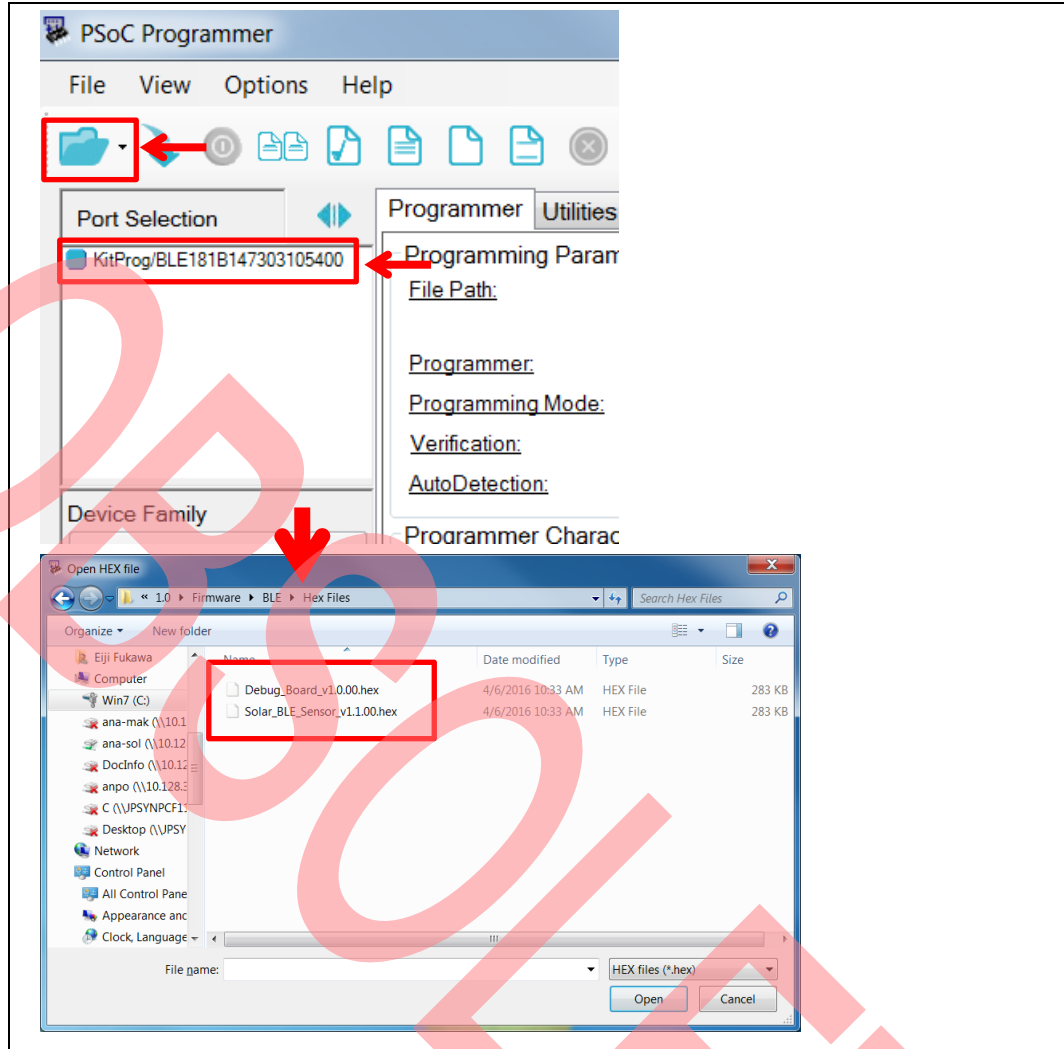
- When PsoC Creator opens in debug mode, use the buttons on the toolbar for debugging. For more details on using the debug features, see the Cypress application note [AN96841 – Getting Started with EZ-BLE Module](#) or [AN94020 – Getting Started with ProC BLE](#).

### 4.2.3 Programming Using PsoC Programmer

PsoC Programmer (3.24 or later) can be used to program existing hex files into both PsoC BLE and the EZ-BLE module. To do so, follow these steps.

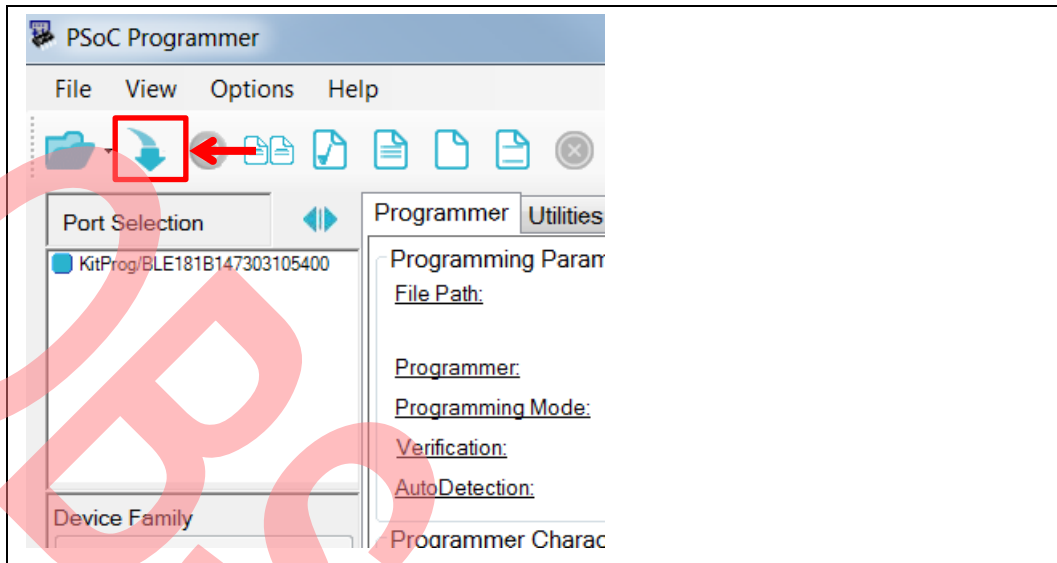
- Refer to [4.2.1 Initial setup](#) to select the target device.
- Plug the Debug Board into your computer's USB port and open PsoC Programmer from **Start > All Programs > Cypress > PsoC Programmer <version> > PsoC Programmer <version>**.
- Select "KitProg/BLE\*\*\*\*\*" in **Port Selection**, and then click the File Load button at the top left corner of the window. Browse for the desired hex file and click **Open**. The example hex files are located in the **Hex Files** folder.

*<Install directory>\CYALKIT-E02 Solar-Powered BLE Sensor Beacon RDK<version>\Firmware\BLE\Hex Files*

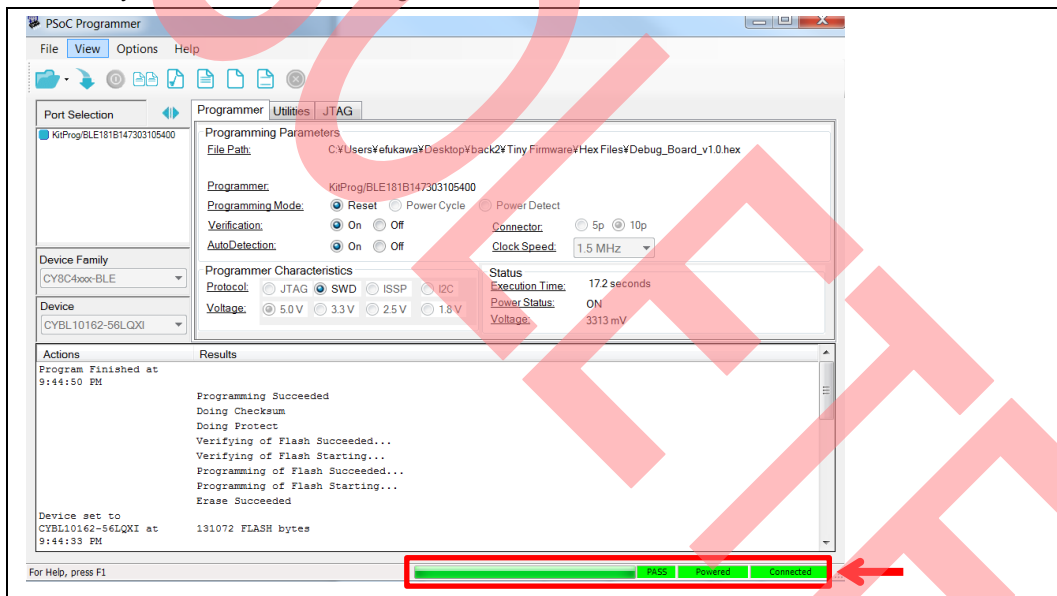


- Click the **Program** button to start programming the kit with the selected file.

**Note:** If the hex file does not match the device selected, then PsoC Programmer will throw an error of device mismatch and terminate programming.



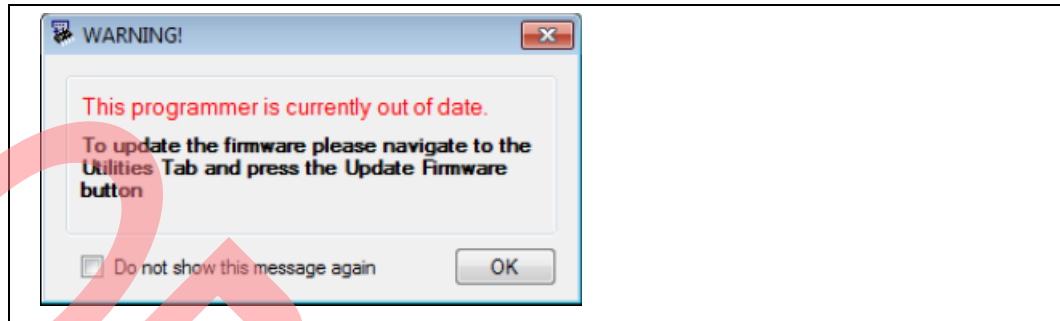
- When programming is finished successfully, indicated by a **PASS** message on the status bar, the Solar BLE Sensor or Debug Board is ready for use. Close PsoC Programmer.



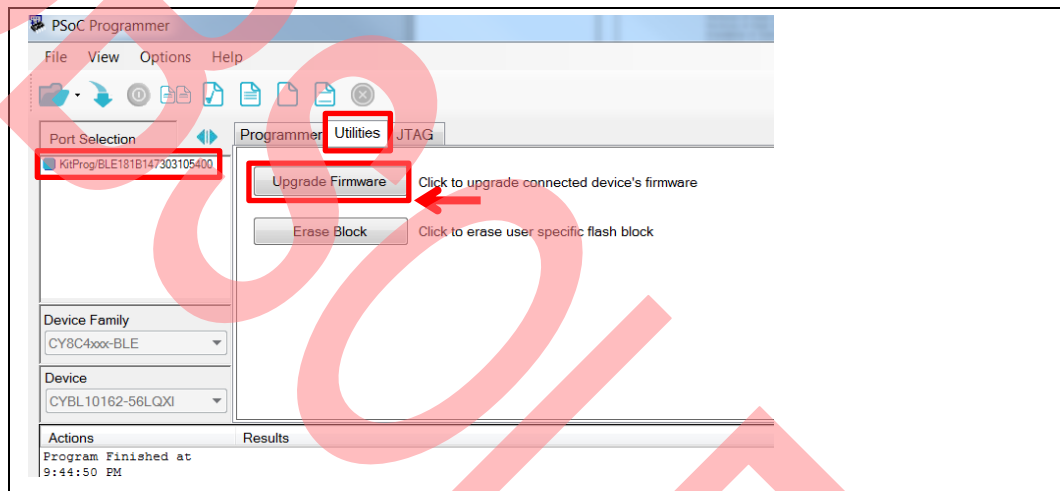


## 4.3 Updating KitProg Firmware

The KitProg firmware normally does not require any updating. If an update is required, then PsoC Programmer will display a warning message when the kit is connected to it, as follows.



To update KitProg, go to the **Utilities** tab in PsoC Programmer and click **Upgrade Firmware**, as follows.



# 5. Reference Design



This chapter introduces you to the Solar BLE Sensor hardware and firmware initially provided. It discusses features such as the WSN with the BLE Beacon process.

## 5.1 Hardware Description

The Solar BLE Sensor has two modes: Demo mode and Timer mode. Refer to section [Internal Timer Setting Block](#) for detailed information. You can set these modes using SW1 on the Solar BLE Sensor. This section details the information for S6AE103A.

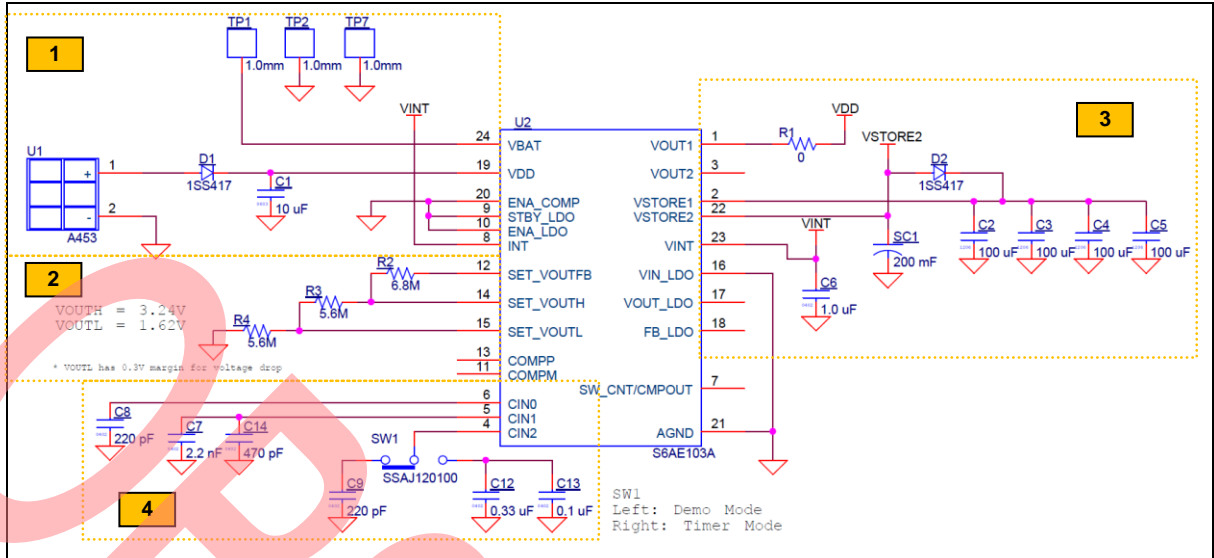
**Note:** When the Solar BLE Sensor is in the enclosure, use the sharp end of something like tweezers (not included in the kit) to change the mode.



The following is the circuit of the S6AE103A energy harvesting PMIC. There are four main blocks to operate it. Refer to the [S6AE103A datasheet](#) for detailed specifications. The schematic and board layouts are available at the following location:

<Install directory>\CYALKIT-E02 Solar-Powered BLE Sensor Beacon RDK\<version>\Hardware

1. Power input block
2. VOUT setting block
3. Storage and VOUT control block
4. Internal timer setting block



### 5.1.1 Power Input Block

This section describes the S6AE103A power input block as shown in the following schematic. There are two power inputs for solar energy (VDD) and primary battery input (VBAT) and some control pins for internal LDO, comparator, and interrupt input.

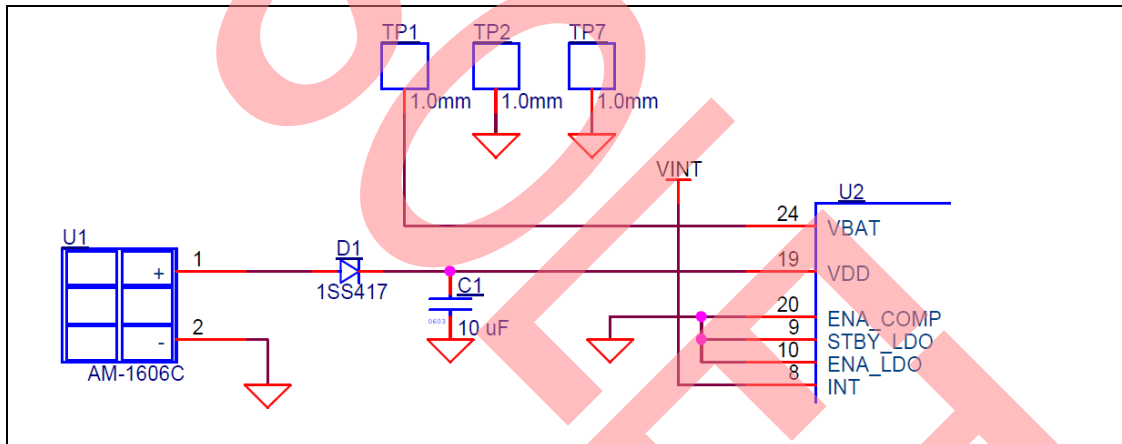


Table 5-1. Pin Description of Power Input Block

Pin Name:	Description:
VBAT	Connect TP1 Primary battery input pin Extra battery input
VDD	Connect the solar cell (AM-1606C) Solar cell input pin Diode (D1) for reverse current protection Capacitor (C1) for charging input energy
ENA_COMP	Connect GND (H: Enable, L: Disable) Comparator control pin It is set to disable.
STBY_LDO	Connect GND (H: Normal, L: Standby) LDO operation mode setting pin The LDO is not used when ENA_LDO is low.

Pin Name:	Description:
ENA_LDO	Connect GND (H: Enable, L: Disable) LDO output control pin It is set to disable.
INT	Connect VINT Event-driven mode control pin VOUT2 is always active.

### 5.1.1.1 Solar Cell Specification

Refer to [section 6.1.1 15 x 15 mm Solar Cell](#) for detailed specifications.

### 5.1.1.2 Diode Connection Between Solar Cell and VDD

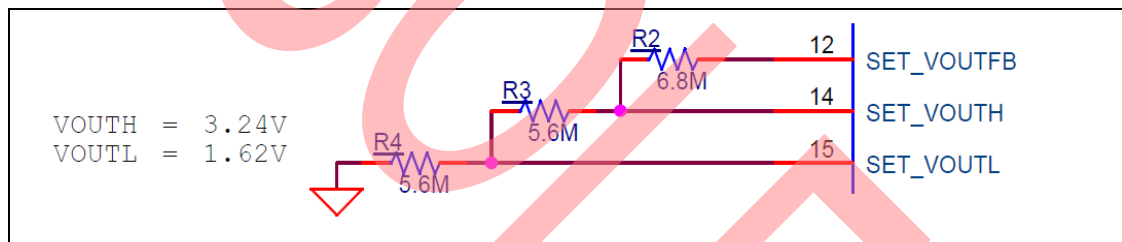
Refer to [Diode Connection Between Solar Cell and VDD](#) for detailed information.

### 5.1.1.3 VBAT Connection (optional)

Refer to [Battery Input Operation](#).

## 5.1.2 VOUT Setting Block

This section describes the VOUT settings of S6AE103A as shown in the following schematic. The VOUT1 and VOUT2 output voltage of S6AE103A can be set by changing the resistors connected to the SET\_VOUTH and SET\_VOUTL pins because the VOUT upper limit voltage (VVOUTH) and VOUT lower limit voltage (VVOUTL) are set based on the connected resistors. The SET\_VOUTFB pin outputs a reference voltage for setting the VOUT upper limit voltage and VOUT lower limit voltage. The voltages applied to the SET\_VOUTH and SET\_VOUTL pins are produced by dividing this reference voltage outside the IC.



The VOUT upper limit voltage (VVOUTH) and VOUT lower limit voltage (VVOUTL) can be calculated using the following equations:

VOUT upper limit voltage

$$V_{VOUTH} [V] = \frac{57.5 \times (R3 + R4)}{11.1 \times (R2 + R3 + R4)} = \frac{57.5 \times (5.6M + 5.6M)}{11.1 \times (6.8M + 5.6M + 5.6M)} = 3.24 V$$

VOUT lower limit voltage

$$V_{VOUTL} [V] = \frac{57.5 \times R3}{11.1 \times (R2 + R3 + R4)} = \frac{57.5 \times 5.6M}{11.1 \times (6.8M + 5.6M + 5.6M)} = 1.62 V$$

### 5.1.2.1 VOUTL Setting Margin

Refer to [Equivalent Series Resistance of the Supercapacitor](#).

### 5.1.3 Storage and VOUT Control Block

This section describes the storage and VOUT control block of S6AE103A as shown in the following schematic. There are two storage pins and two VOUT pins. The solar energy charges both a small capacitor (400  $\mu\text{F}$ ) and a large capacitor (200 mF).

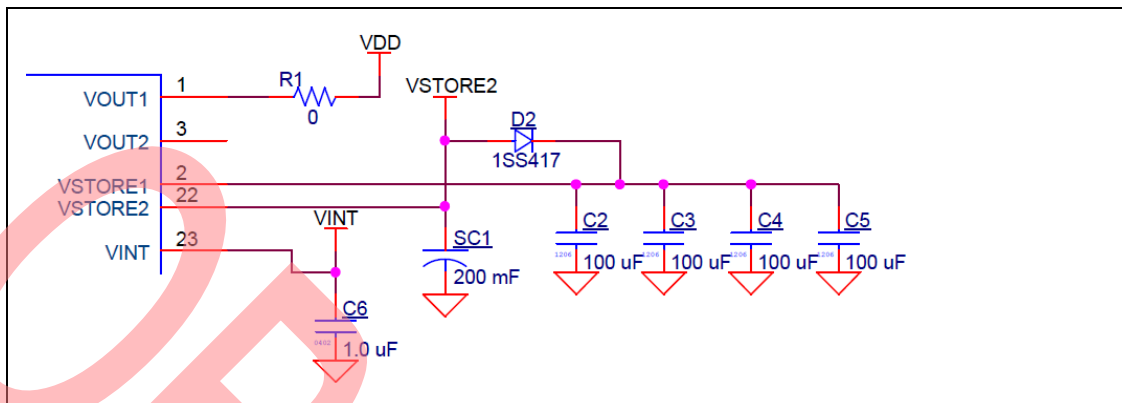


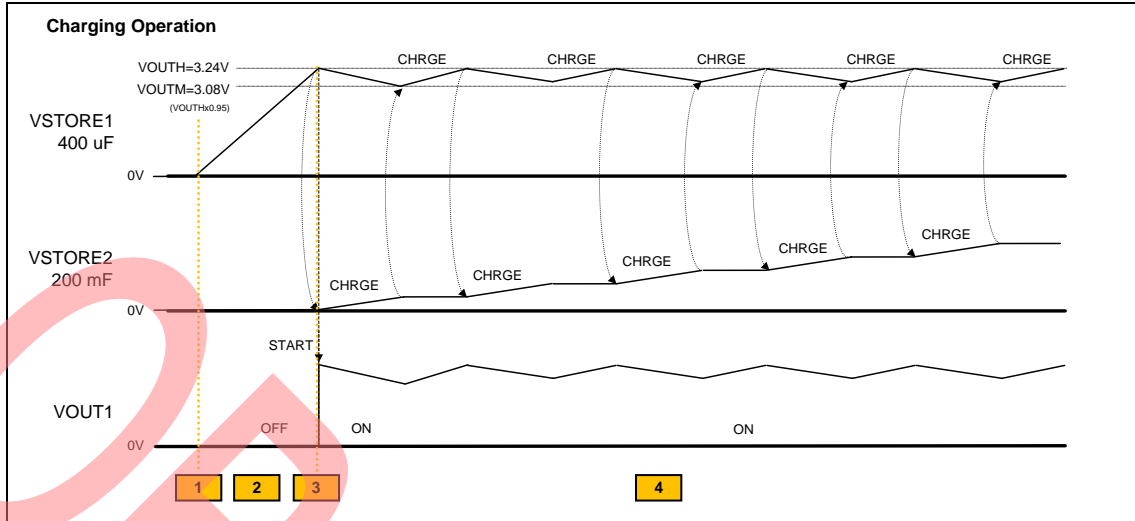
Table 5-2. Pin Description of Storage and VOUT Control Block

Pin Name:	Description:
VOUT1	Connect load Output voltage pin 1 Supply energy to BLE and sensor
VOUT2	Open Output voltage pin 2 Not used for this kit
VSTORE1	Connect 400- $\mu\text{F}$ capacitor Storage output pin 1 For startup storage
VSTORE1	Connect 200-mF capacitor Storage output pin 2 To charge a surplus energy
VINT	Connect 1.0- $\mu\text{F}$ capacitor Internal circuit storage output pin Fixed to connect capacitor

#### 5.1.3.1 Waveform of Charging and Discharging Operation

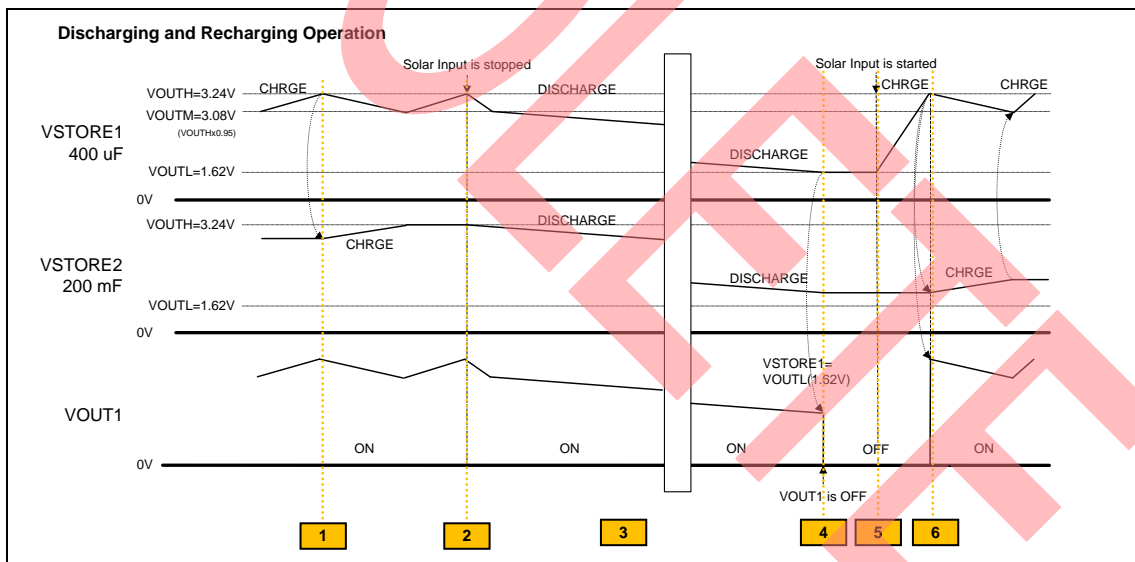
The following are the details of the charging operation and waveform.

1. Solar energy is the input.
2. Charging starts VSTORE1.
3. When the VSTORE1 voltage achieves the VOUTH setting voltage (3.24 V), the VOUT1 voltage turns on and charging starts the surplus energy to VSTORE2.
4. Repeat to charge both VSTORE1 and VSTORE2.



The following are the details of the discharging and recharging operation and waveform.

1. When the VSTORE1 voltage achieves the VOUTH setting voltage (3.24 V), the surplus energy charges to VSTORE2.
2. Solar input is stopped.
3. The voltage decreases slowly due to load current.
4. When the VSTORE1 voltage achieves VOUTL (1.62 V), the VOUT1 turns off.
5. Solar input is started.
6. When the VSTORE1 voltage achieves the VOUTH setting voltage (3.24 V), the VOUT1 voltage turns on and charging starts the surplus energy to VSTORE2.



### 5.1.4 Internal Timer Setting Block

This section describes the S6AE103A internal timer setting block as shown in the following. There are three pins (CIN0/1/2) to control the VOUT pins, as described in [Table 5-3](#).

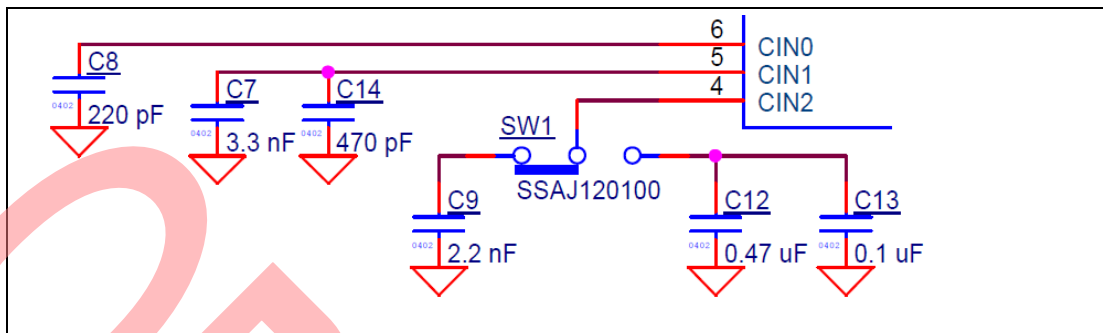


Table 5-3. Pin Description of Internal Timer Setting Block

Pin Name:	Mode	Description
CIN0 (not used)	–	Connect 220-pF Timer time 0 (T0) setting pin T0 = 0.13 sec <sup>1</sup>
CIN1	–	Connect 3770-pF Timer time 1 (T1) setting pin T1 = 2.07 sec <sup>1</sup>
CIN2	Demo mode (C9)	Connect 2200-pF capacitor Timer time 2 (T2) setting pin T2 = 1.21 sec <sup>1</sup>
	Timer mode (C12, C13)	Connect 0.57-μF capacitor Timer time 2 (T2) setting pin T2 = 310 sec <sup>1</sup>

<sup>1</sup> Refer to section [05.1.4.2 Setting of Timer](#) for detailed calculation formulas.

#### 5.1.4.1 Waveform of Demo Mode and Timer Mode

The following are the details of the Demo mode (DM) operation and waveform.

##### Case1: VSTORE2 is empty

- T0 (0.13 s) timer and T1 (2.07 s) timer start when the VSTORE1 achieves VOUTH (3.24 V). VOUT1 voltage turns ON.
- After T0 (0.13 s) finishes, VOUT2 turns ON.
- After T1 (2.07 s) finishes, VOUT1 and VOUT2 turn OFF. T2 (1.21 s) starts. If the VSTORE1 voltage drops under VOUTL (1.62 V), all timers are reset.
- After T2 (1.21 s) finishes, repeat steps 1 to 4.

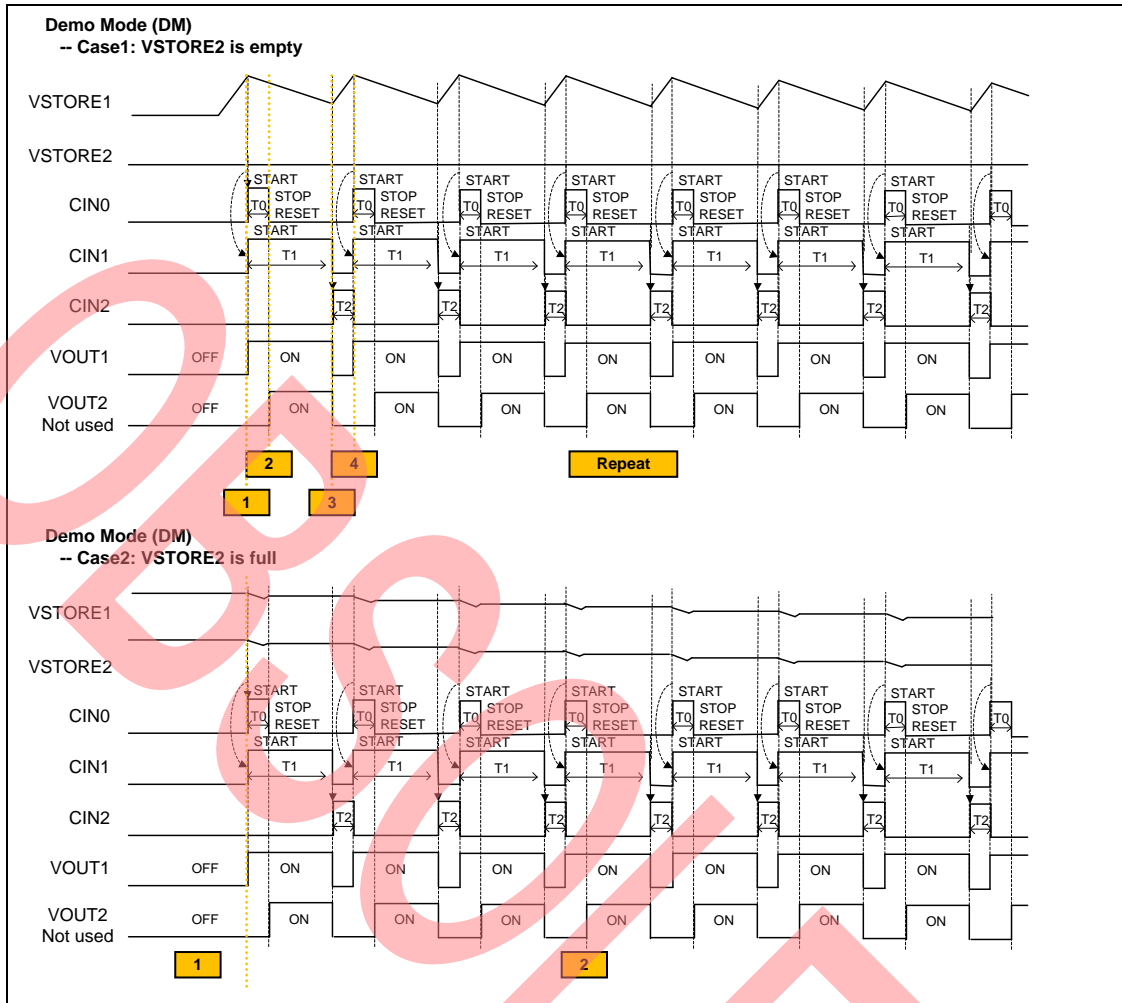
Refer to [Table 3-1. Light Level Versus Time Interval](#) for the time interval of BLE transmission in this case.

##### Case2: VSTORE2 is full

- VSTORE1 and VSTORE2 connect via Diode.
- Same steps as case1.

The time interval of BLE transmission is 3.28 s (T1 + T2) until VSTORE1 drops to VOUTL (1.62 V). Then the waveform changes to case 1.

Note that the surplus energy cannot be charged completely to VSTORE2 in Demo mode.

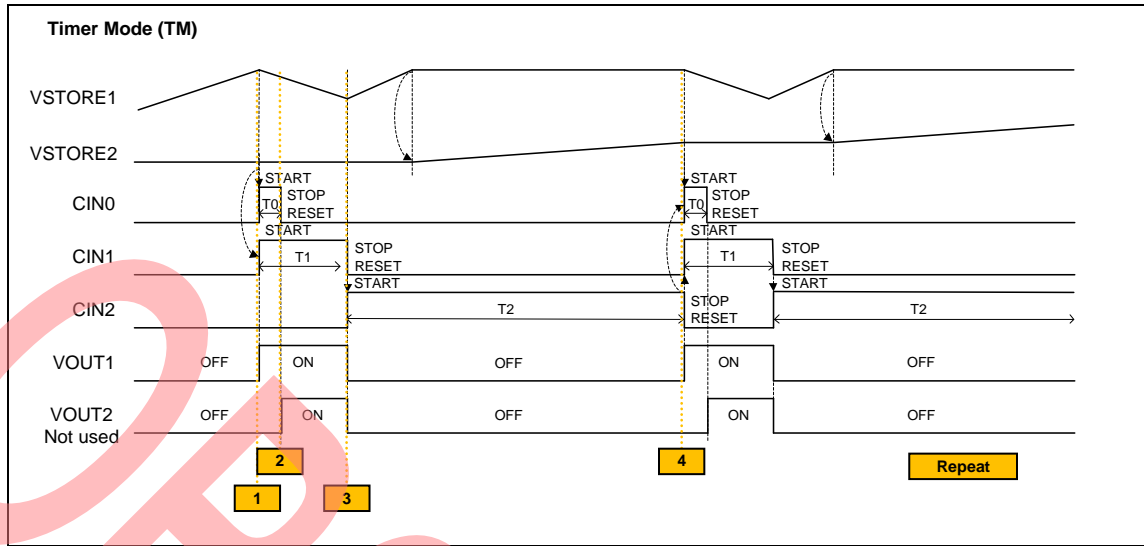


The following are details of the Timer mode I operation and waveform:

1. T0 (0.13 s) timer and T1 (2.07 s) timer start when VSTORE1 achieves VOUTH (3.24 V). VOUT1 voltage turns ON.
2. After T0 (0.13 s) finishes, VOUT2 turns ON.
3. After T1 (2.07 s) finishes, VOUT1 and VOUT2 turn OFF. T2 (310 s) starts. The surplus energy can be charged to VSTORE2 in Timer mode while VOUT1 is OFF.
4. After T2 (310 s) finishes, repeat steps 1 to 4.

The time interval of BLE transmission is 312.07 s (T1 + T2).





### 5.1.4.2 Setting of Timer

The timer times 0, 1, and 2 (T0, T1, and T2) are set according to the capacitance value at the connections between the CIN0, CIN1, and CIN2 pins and the AGND pin.

The values of timer 0 (T0), timer 1 (T1), and timer 2 (T2) can be calculated using the following formulas.

$$T0[s] = 0.5455 \times C[F] \times 10^9 + 0.01327[s] = 0.5455 \times 220 \times 10^{-12} \times 10^9 + 0.01327[s] = 0.13 [s]$$

$$T1[s] = 0.5455 \times 3.77 \times 10^{-9} \times 10^9 + 0.01327[s] = 2.07 [s]$$

$$T2[s] = 0.5455 \times 2.2 \times 10^{-9} \times 10^9 + 0.01327[s] = 1.21 [s] \text{ (Demo mode)}$$

$$T2[s] = 0.5455 \times 570 \times 10^{-9} \times 10^9 + 0.01327[s] = 310 [s] \text{ (Timer mode)}$$

### 5.1.5 Unused Pins

Table 5-4 lists the unused pins.

Table 5-4. Description of Unused Pins

Pin Name	Description
COMPP	Open Comparator input pin
COMPM	Open Comparator input pin
VOUT2	Open Output voltage pin
VIN_LDO	Connect GND LDO power input pin
VOUT_LDO	Open LDO output pin
FB_LDO	Open LDO output voltage setting pin
SW_CNT/CMPOUT	Open VOUT1 switch interlocking output pin/comparator output pin

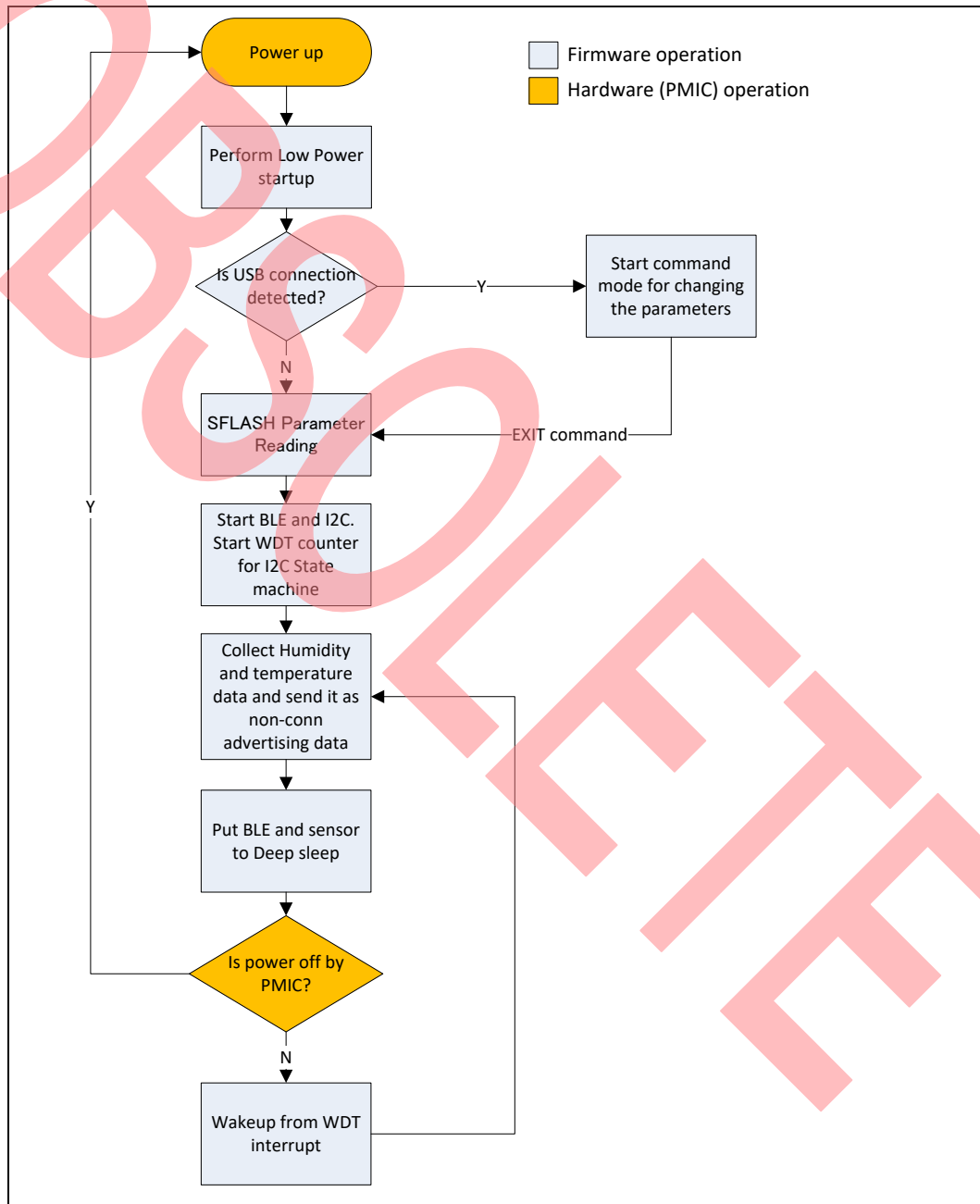
## 5.2 Firmware Description

This section introduces the firmware initially provided in the Solar-Powered BLE Sensor Beacon RDK. It discusses features such as the WSN with the BLE Beacon process. Refer to [AN96841 – Getting Started with EZ-BLE Module](#) for the BLE standard reference design, except energy harvesting.

### 5.2.1 Flow Diagram

Figure 5-1 is the flow diagram for the example project of the kit firmware.

Figure 5-1. Example Project Flow Chart



## 5.2.2 Function List

Table 5-5 lists the functions for the example project of the kit firmware.

Table 5-5. Example Project Functions

Function Name	Description
CyDelay	Wait for milliseconds
CyDelayUs	Wait for microseconds
USB_Detect_Read	Reads the current value on the pins (P3.5) of the digital port in right justified
UART_Start	Invokes SCB_Init() and SCB_Enable()
UART_UartPutString	Places a NULL terminated string in the transmit buffer to be sent at the next available bus time
CySoftwareReset	Forces a software reset of the device
CySysClkWriteEcoDiv	Sets the divider for the ECO
CySysClkEcoStart	Starts the ECO
CySysClkEcoStop	Stops the MHz crystal
WDT_Interrupt_StartEx	Initialize WDT interrupt
CySysClkWcoStart	Enables the WCO
CySysClkWcoSetPowerMode	Sets power mode for the 32-kHz WCO
CySysWdtLocked	Reports WDT lock state
CySysClkSetLfclkSource	Sets clock source for the LFCLK clock
CySysWdtEnable	Enables specified WDT counters
CySysWdtLock	Locks out configuration changes to the WDT registers and ILO configuration register
CySysWdtUnlock	Unlocks the watchdog timer configuration register
CySysPmDeepSleep	Puts the part into the deep sleep state
CySysWdtEnable	Enables the specified WDT counters
CySysWdtDisable	Disables the specified WDT counters
ConfigRW_CheckSFlash	Checks whether there is configuration data in user Sflash
cmd_uart_sub	Function for processing UART commands
CyBle_Start	Initializes the BLE stack, which consists of the BLE Stack Manager, BLE Controller, and BLE Host modules
CyBle_ProcessEvents	Checks the internal task queue in the BLE Stack and pending operation of the BLE Stack
CyBle_EnterLPM	Requests the underlying BLE modules such as BLE Controller, BLE Host Stack, and BLE Stack Manager to enter into one of the supported low-power modes
CyEnterCriticalSection	No interrupts allowed while entering system low-power modes
CySysPmDeepSleep	Puts the part into the deep sleep state
CySysClkWriteHfclkDirect	Selects the direct source for the HFCLK
CySysClkImoStart	Enables the IMO
CySysClkImoStop	Disables the IMO
CySysPmSleep	Puts the part into the sleep state
ProcessI2Cevents	Handles I <sup>2</sup> C events according to current state and updates the state value
ProcessBeaconEvents	Handles beacon events according to current state and updates the state value
Si7020_Init	Initial temperature and humidity sensor Si7020
Si7020_WriteRead	Sends conversion command and reads temperature and humidity data
Beacon_GappStartAdvertisement	Starts advertisement using the specified interval

Function Name	Description
CyBle_GappStopAdvertisement	Exits discovery mode

### 5.2.3 BLE Sensor Beacon Operation

This section provides detailed information on the BLE sensor beacon process.

#### 5.2.3.1 Complete BLE Sensor Beacon Process

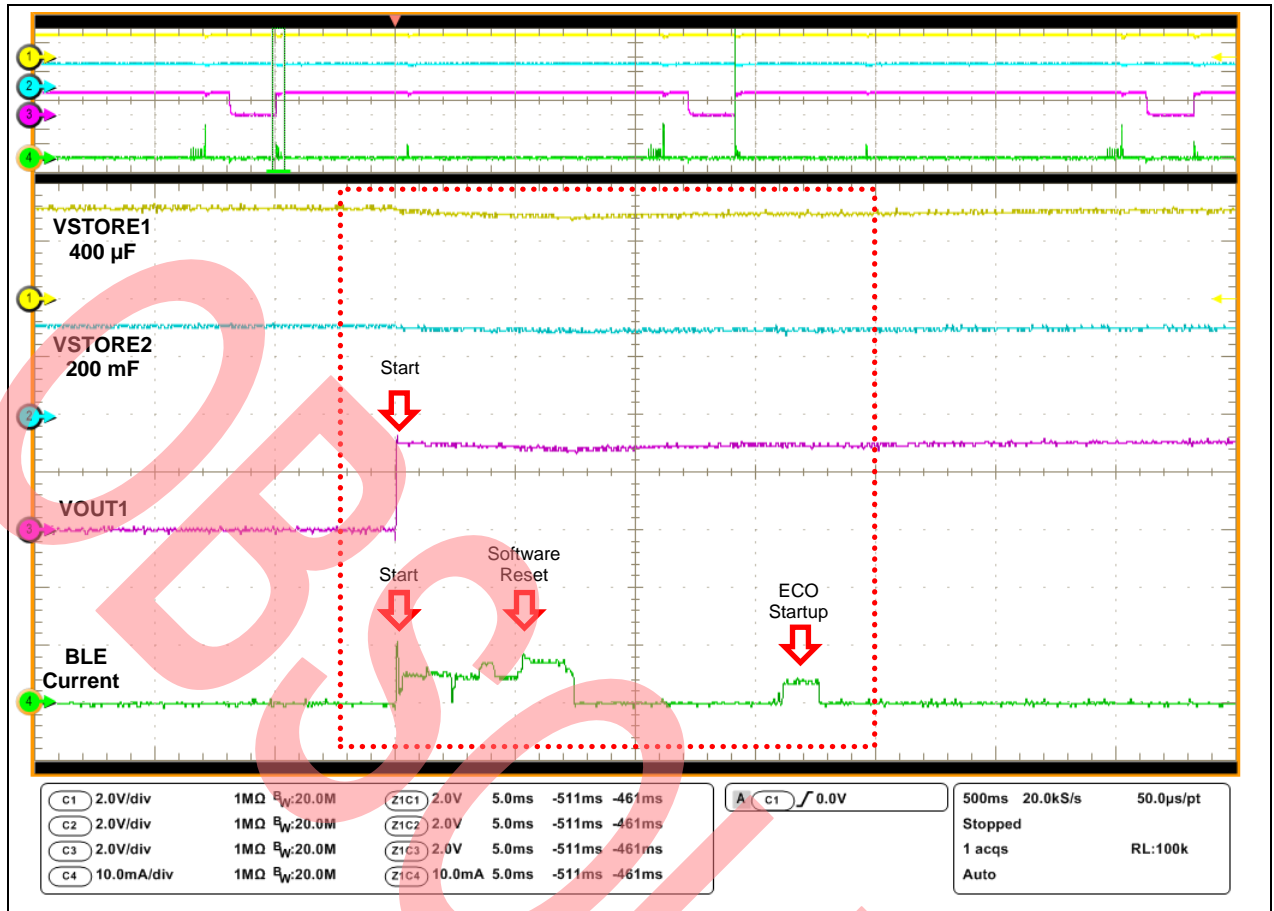
The complete BLE sensor beacon process invokes running the Beacon\_GappStartAdvertisement(). The following waveform shows the BLE advertisement states.



#### 5.2.3.2 Power Up and Software Reset

The code from the Solar\_BLE\_Sensor PsoC Creator project is started. This code begins with low-power startup functions. This allows the system to conserve power during clock startup, especially the WCO, which takes 500 ms for startup. This is crucial to allow the project to survive on solar power.

The code is optimized to read the USB detect line (P3.5 of EZ-BLE) and immediately switch to UART mode if it was not detected.



```

CyGlobalIntEnable;

/* Set the divider for ECO, ECO will be used as source when IMO is switched
off to save power, to drive the HFCLK */
CySysClkWriteEcoDiv(CY_SYS_CLK_ECO_DIV8);

/* Start WCO & ECO in low power mode */
LowPower_WCO_ECO_Start();

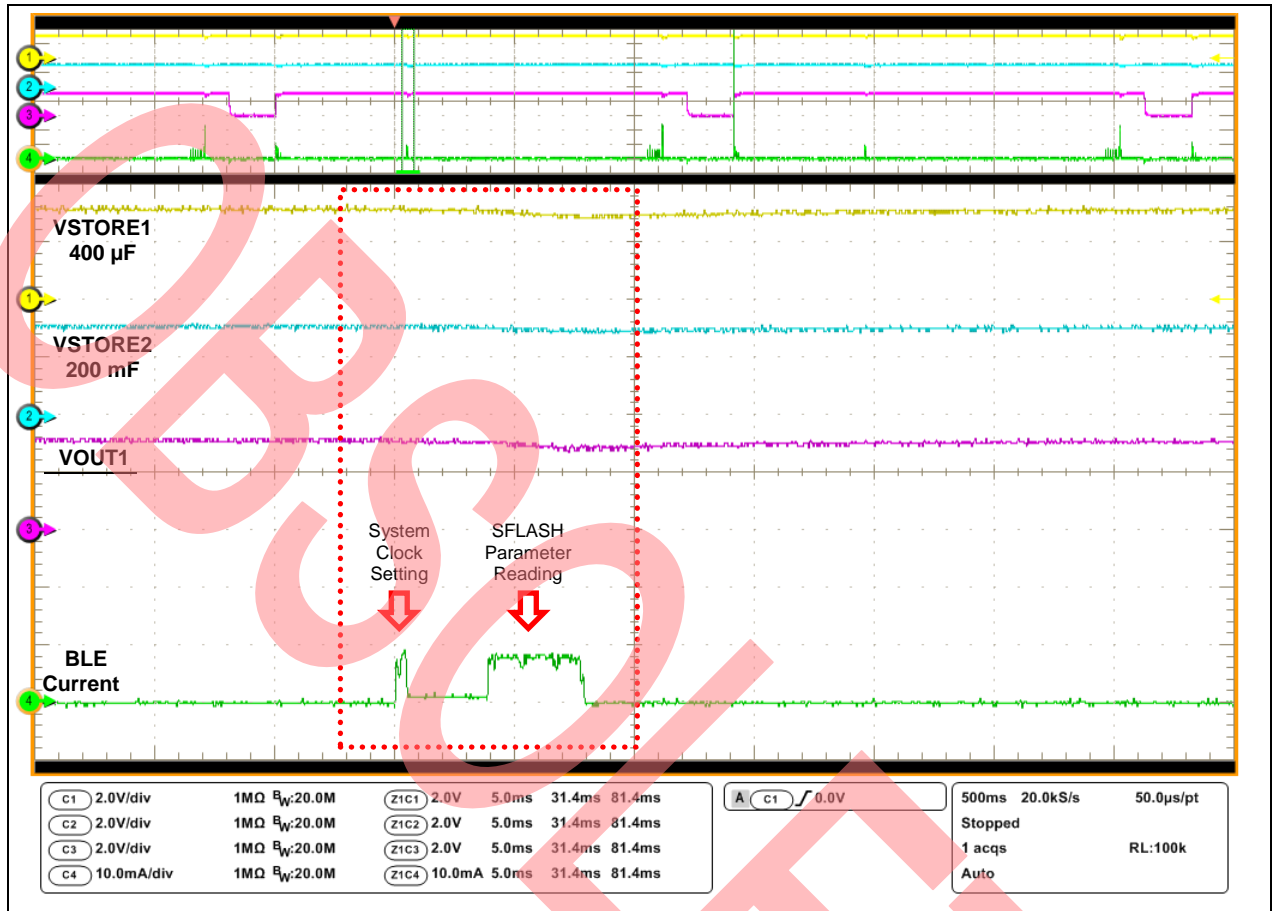
/* If USB connector is plugged in. */
if(USB_Detect_Read() == PIN_HIGH)
{
    ConfigRW_CheckVersion();
    cmd_uart_sub();
}

```

### 5.2.3.3 System Clock Setting and SFLASH Parameter Reading

The system is set with the IMO at 12 MHz and the ECO at 3 MHz.

The user flash read is done at every start to read the stored beacon data in SFLASH and then use it for broadcasting. The flash read is done in CYBLE\_EVT\_STACK\_ON to allow some breathing room between system on and flash read.



```

void BLE_AppEventHandler(uint32 event, void* eventParam)
{
    (void)eventParam;
    switch (event)
    {
        case CYBLE_EVT_STACK_ON:
            /* This event is received when component is Started. */

            /* Read user configuration and apply.
             * ReadAndApplyConfig() must be invoked in the case of
             * CYBLE_EVT_STACK_ON. */
            ReadAndApplyConfig(&interval, &Sensor_Flag);

            restartadvertisement = true;
            CySysWdtUnlock(); /*Unlock the WDT registers for modification*/
            CySysWdtWriteMode(SOURCE_COUNTER, CY_SYS_WDT_MODE_INT);
            CySysWdtWriteClearOnMatch(SOURCE_COUNTER, COUNTER_ENABLE);
            CySysWdtWriteMatch(SOURCE_COUNTER, COUNT_PERIOD_1S);
            CySysWdtEnable(CY_SYS_WDT_COUNTER0_MASK);
            CySysWdtLock();
            break;

        default:
            break;
    }
}

```

#### 5.2.3.4 I<sup>2</sup>C Start, Read Sensor Data and BLE Advertisement

Along with BLE start, the WDT counter is configured for periodic interrupts to run the I<sup>2</sup>C state machine. This state machine initiates I<sup>2</sup>C as well as reads the data from the sensor to send it as part of the advertisement (ADV) packet. Also, CyBle\_ProcessEvents() is called to process BLE events.

After I<sup>2</sup>C is started, the next state sends the temperature or humidity data request, and then the system goes back to deep sleep. After sensor data is requested, temperature or humidity data is read, and the system goes back to deep sleep again.

Upon WDT interrupt, the system wakes up and the ADV packet is updated with the new data. Also, the GAP advertisement is started so that the new ADV packet can be transmitted by BLE.





```
void ProcessI2CEvents(void)
{
    /* If I2C_COUNTER triggers a new interrupt after the expected time elapsed.
    */
    if(wdt_trigger_on_flag)
    {
        CYBLE_API_RESULT_T apiResult;
        switch(i2c_state)
        {
            case I2C_START:
                I2CM_Start();
                I2C_buffer[0] = SI7020_WRITE_USER_REG;
                I2C_buffer[1] = USER_REG_SETTING;
                (void) I2CM_I2CMasterWriteBuf(SI7020_SLAVE_ADDR,
                                             I2C_buffer,
                                             SI7020_USER_REG_SEND_LEN,
                                             I2CM_I2C_MODE_COMPLETE_XFER);
                UpdateWdtCounter1(I2C_COUNT_PERIOD_20MS);
                /* Set next I2C state */
                i2c_state = I2C_READ_HUMIDITY_SEND;
                break;
        }
    }
}
```

```

/* Perform "Measure Relative Humidity" command to Si7020 */
case I2C_READ_HUMIDITY_SEND:
    (void) I2CM_I2CMasterClearStatus();
    /* Request RH data from I2C Sensor */
    I2C_buffer[I2C_BUFFER_HUM_OFFSET_CMD] =
    SI7020_MEASURE_RH;
    (void) I2CM_I2CMasterWriteBuf(SI7020_SLAVE_ADDR,
        I2C_buffer[I2C_BUFFER_HUM_OFFSET_CMD],
        SI7020_MEASURE_RH_SEND_LEN,
        I2CM_I2C_MODE_COMPLETE_XFER);
    UpdateWdtCounter1(I2C_COUNT_PERIOD_20MS);
    /* Set next I2C state */
    i2c_state = I2C_READ_HUMIDITY_RECV;
    break;

/* Read back "Measure Relative Humidity" result from Si7020 */
case I2C_READ_HUMIDITY_RECV:
    /* Read RH data from I2C Sensor */
    (void) I2CM_I2CMasterReadBuf(SI7020_SLAVE_ADDR,
        &I2C_buffer[I2C_BUFFER_HUM_OFFSET_DATA],
        SI7020_MEASURE_RH_RECV_LEN,
        I2CM_I2C_MODE_COMPLETE_XFER);
    UpdateWdtCounter1(I2C_COUNT_PERIOD_20MS);
    /* Set next I2C state */
    i2c_state = I2C_READ_TEMP_SEND;
    break;

/* Perform "Read Temperature Value" command to Si7020 */
case I2C_READ_TEMP_SEND:
    (void) I2CM_I2CMasterClearStatus();
    /* Request Temperature data from I2C Sensor */
    I2C_buffer[I2C_BUFFER_TEM_OFFSET_CMD] =
    SI7020_READ_TEMP;
    (void) I2CM_I2CMasterWriteBuf(SI7020_SLAVE_ADDR,

```

```

        /* Start BLE Advertisement */
        case I2C_START_ADV:
            /* Update RH index of ADV packet with new value */
            cyBle_discoveryData.advData[ADDR_HUM_OFFSET] =
                I2C_buffer[I2C_BUFFER_HUM_OFFSET_DATA];
            /* Update Temperature index of ADV packet with new value */
            cyBle_discoveryData.advData[ADDR_TEM_OFFSET] =
                I2C_buffer[I2C_BUFFER_TEM_OFFSET_DATA];
            (void) I2CM_I2CMasterClearStatus();
            /*When sensor used, advertise interval is fixed to 10.24s.*/
            apiResult =
                Beacon_GappStartAdvertisement(ITRVL_SENSOR_ON);
            /* If fails to start advertisement, halt the processor. */
            if(apiResult != CYBLE_ERROR_OK)
            {
                CYASSERT(0);
            }
            CyBle_ProcessEvents();
            UpdateWdtCounter1(I2C_COUNT_PERIOD_1S);
            /* Set next I2C state */
            i2c_state = I2C_STOP_ADV;
        break;

        case I2C_STOP_ADV:
            CyBle_GappStopAdvertisement();
            CyBle_ProcessEvents();
            /* Set next I2C state */
            i2c_state = I2C_READ_HUMIDITY_SEND;
        break;
    }

    wdt_trigger_on_flag = false;
}
}

```

### 5.3 BLE Beacon Format

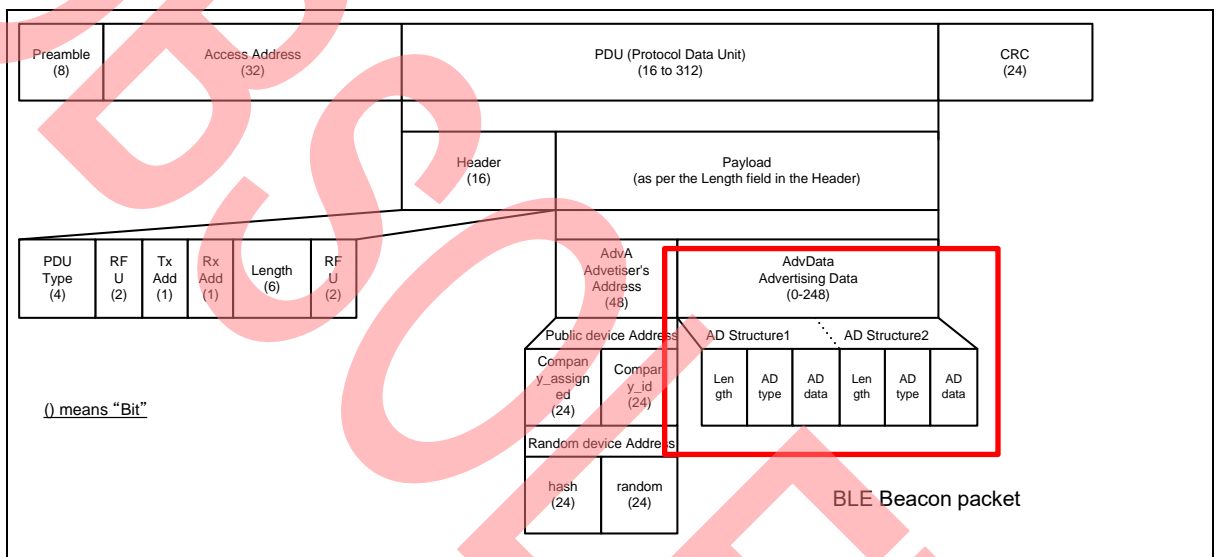
The BLE Beacon is a one-way communication method that broadcasts at a regular interval. It consists of small packets of data (30 bytes) of “advertisements.”

Beacons that want to be “discovered” can be used for a variety of smartphone or computer applications to trigger things like push messages, app actions, and prompts.

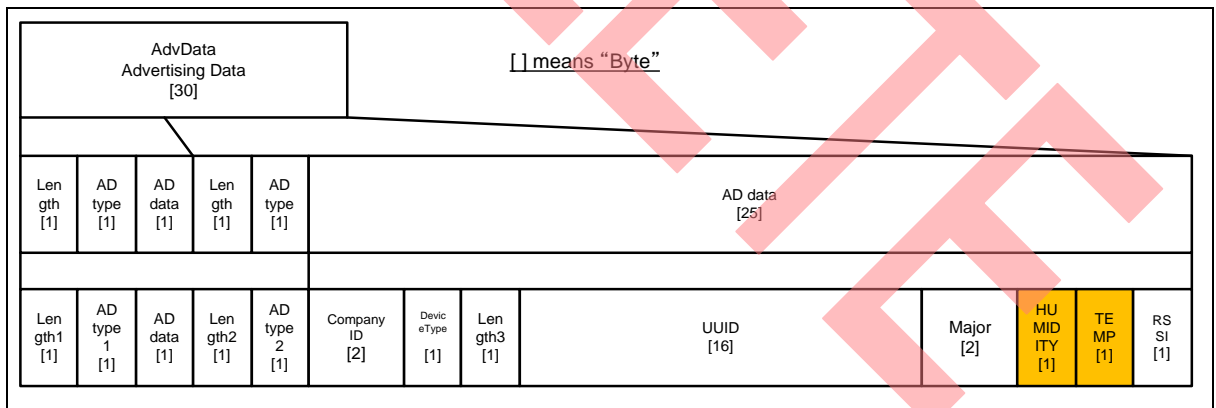
The following is the link layer format of the BLE for advertising channel packet format. The BLE link layer includes “Preamble,” “Access Address,” “PDU (Protocol Data Unit),” and CRC. Note that the following information is for the advertising channel packet format; it does not include the data channel packets.

- “Preamble” must set “10101010b.”
- “Access Address” must be set to “10001110100010011011111011010110b (0x8E89BED6).”
- “PDU” includes “Header” and “Payload.”

The BLE Beacon packet structure belongs to “Advertising Data” in “Payload.”



The following are the details of the BLE Beacon packet format for the kit.



The following are the initial values in the example project for Solar\_BLE\_Sensor.

#### <BLE Beacon Format>

Length1	0x02
AD type1	0x01
AD data	0x04

Length2	0x1A
AD type2	0xFF
Company ID	0x004C
Device type	0x02
Length3	0x15
UUID <sup>1</sup>	00050001-0000-1000-8000-00805F9B0131 [hex]
Major <sup>2</sup>	0x0001
HUMIDITY <sup>3</sup>	Humidity Sensor Data
TEMP <sup>3</sup>	Temperature Sensor Data
RSSI <sup>4</sup>	0xC3 [-61dBm]

**<Others>**

Transmitter power	3 dBm
-------------------	-------

<sup>1</sup> This is a 16-byte string used to differentiate a large group of related beacons.

<sup>2</sup> This is a 2-byte string used to distinguish a smaller subset of beacons within the larger group.

<sup>3</sup> This is a 1-byte string to read individual sensor data.

<sup>4</sup> Received signal strength indication. This is used to determine proximity to (distance from) the beacon.

The kit uses the ReadAndApplyConfig function in *main.c* to update the BLE Beacon packet. Note that the kit does not use the "GAP Settings" of Configure "BLE" in *TopDesign.cysch* because the SFLASH parameter is read and the BLE Beacon packet is updated whenever the power is turned on.

### 5.3.1 Calculation Formula to Read Sensors

The following is the calculation formula of the temperature and humidity sensors to receive the sensor data.

**<Temperature Sensor>**

$$\text{TEMP } [^{\circ}\text{C}] = 175.72 \times (\text{TEMP} \times 256) / 65536 - 46.85$$

Example: TEMP = 0x67 [hex] = 103[dec]

$$\text{TEMP } [^{\circ}\text{C}] = 175.72 \times (103 \times 256) / 65536 - 46.85 = 23.85[^{\circ}\text{C}]$$

**<Humidity Sensor>**

$$\text{RH}[\%] = 125 \times (\text{HUMIDITY} \times 256) / 65536 - 6$$

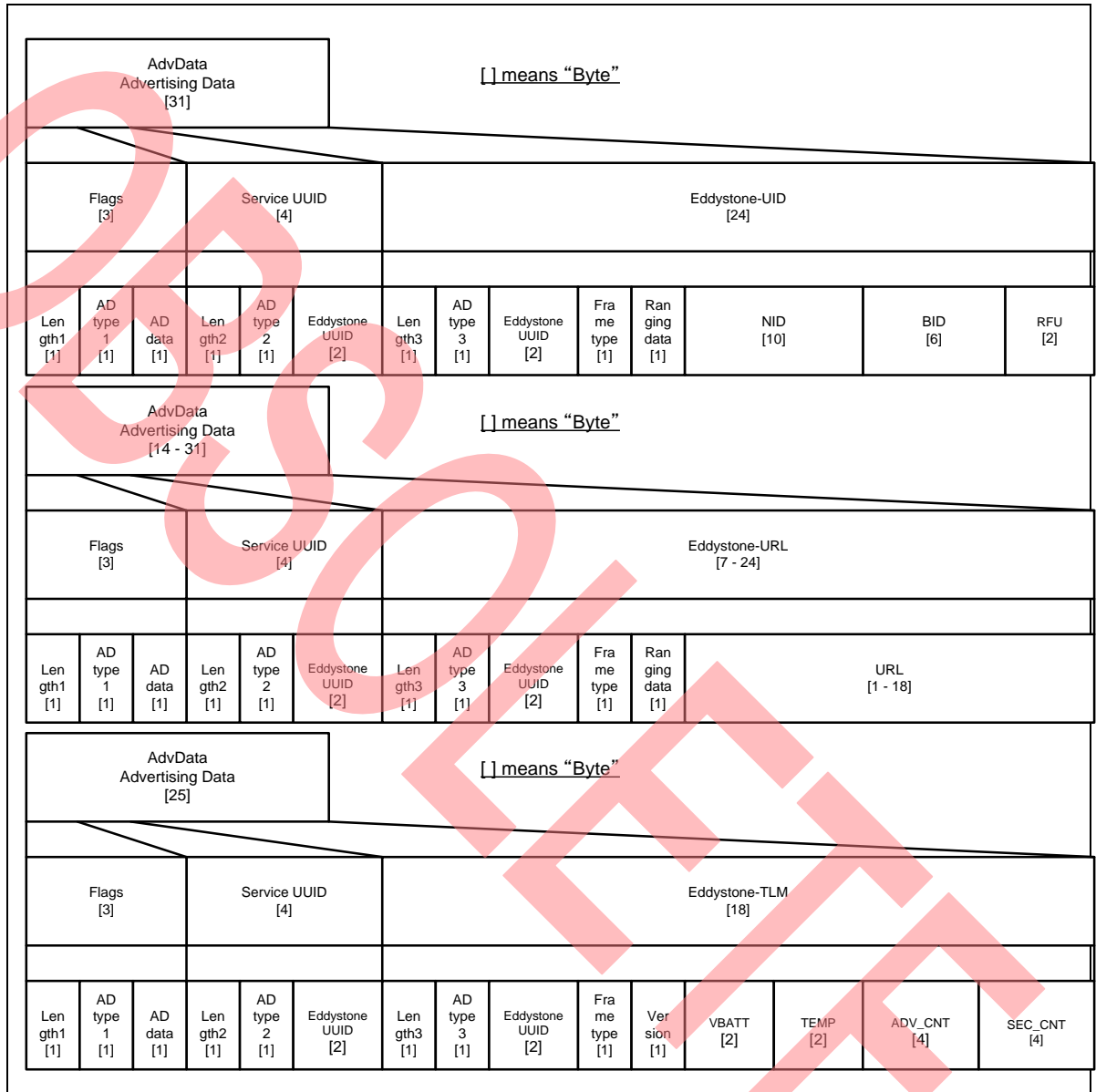
Example: HUMIDITY = 0x74 [hex] = 116[dec]

$$\text{RH}[\%] = 125 \times (116 \times 256) / 65536 - 6 = 50.64[\%]$$

## 5.4 Eddystone Format

The Eddystone specification defines three types of frames. The two AD structures in the front are the same.

The following diagram shows the Eddystone packet format using the same format used in <https://github.com/google/eddytone/blob/master/protocol-specification.md>



The following are the initial values in the example project for "Solar-Powered BLE Beacon Operation".

<Flags>

- Length1 0x02
- AD type1 0x01
- AD data 0x04

<Service UUID>

- Length2 0x03

<input type="checkbox"/>	AD type2	0x03
<input type="checkbox"/>	Eddystone UUID	0xFEAA
<Eddystone-UID>		
<input type="checkbox"/>	Length3	0x17
<input type="checkbox"/>	AD type3	0x16
<input type="checkbox"/>	Eddystone UUID	0xFEAA
<input type="checkbox"/>	Frame type	0x00 [UID]
<input type="checkbox"/>	Ranging data	0xDD [-35dBm]
<input type="checkbox"/>	NID	CB6F15CEC02A41F76AB1 [hex]
<input type="checkbox"/>	BID	00000010001 [hex]
<input type="checkbox"/>	RFU	0x0000
<Eddystone-URL>		
<input type="checkbox"/>	Length3	0x0E
<input type="checkbox"/>	AD type3	0x16
<input type="checkbox"/>	Eddystone UUID	0xFEAA
<input type="checkbox"/>	Frame type	0x10 [URL]
<input type="checkbox"/>	Ranging data	0xDD [-35dBm]
<input type="checkbox"/>	URL	006379707265737300 [hex] [http://www.cypress.com/]
<Eddystone-TLM>		
<input type="checkbox"/>	Length3	0x11
<input type="checkbox"/>	AD type3	0x16
<input type="checkbox"/>	Eddystone UUID	0xFEAA
<input type="checkbox"/>	Frame type	0x20 [TLM]
<input type="checkbox"/>	Version	0x00
<input type="checkbox"/>	VBATT	0x0000 [not supported]
<input type="checkbox"/>	TEMP	0x8000 [-128 °C, not supported]
<input type="checkbox"/>	ADV_CNT	0
<input type="checkbox"/>	SEC_CNT	0
<Others>		
<input type="checkbox"/>	Transmitter power	-12 dBm
<input type="checkbox"/>	Advertise interval	100 ms

# 6. Hardware



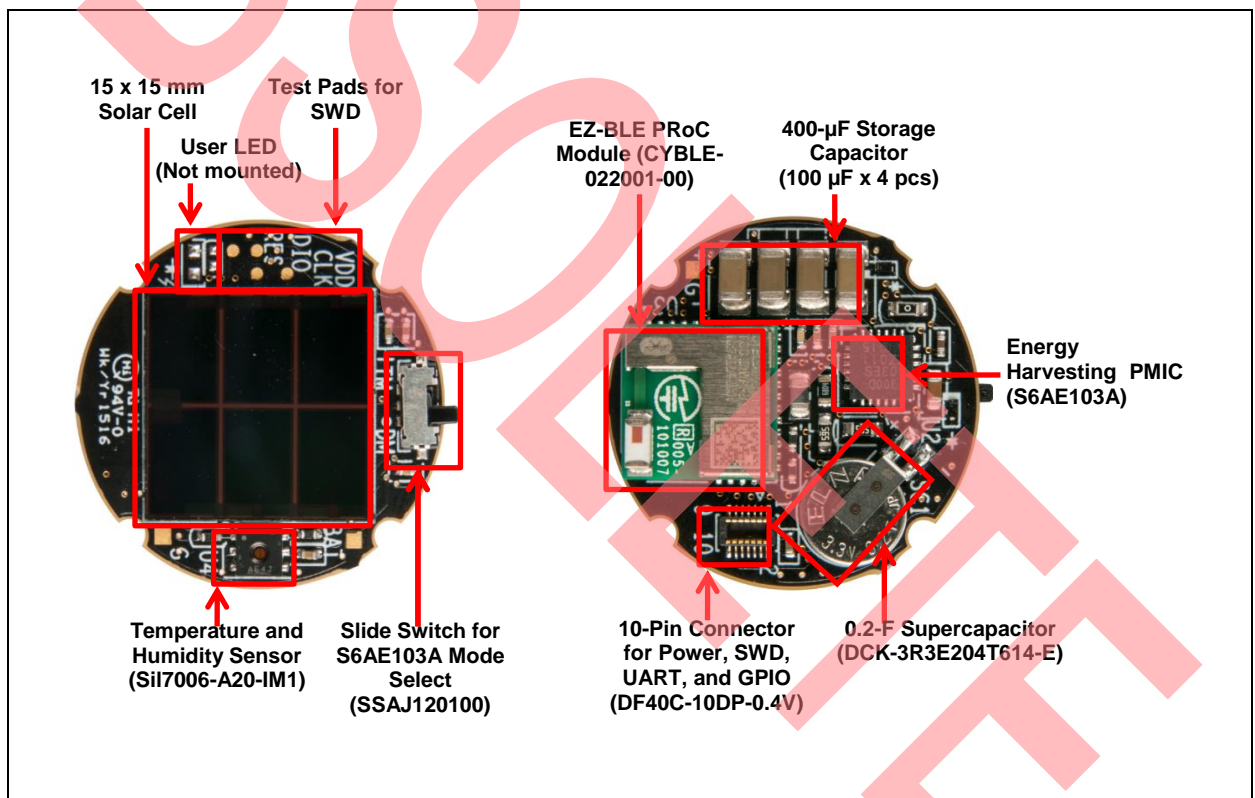
This chapter describes the Solar-Powered BLE Sensor Beacon RDK hardware. The schematic and board layouts are available at the following location:

<Install Directory>\Cypress\CYALKIT-E02 Solar-Powered BLE Sensor Beacon RDK<version>\Hardware.

## 6.1 Solar BLE Sensor

The Solar BLE Sensor consists of the blocks shown in Figure 6-1.

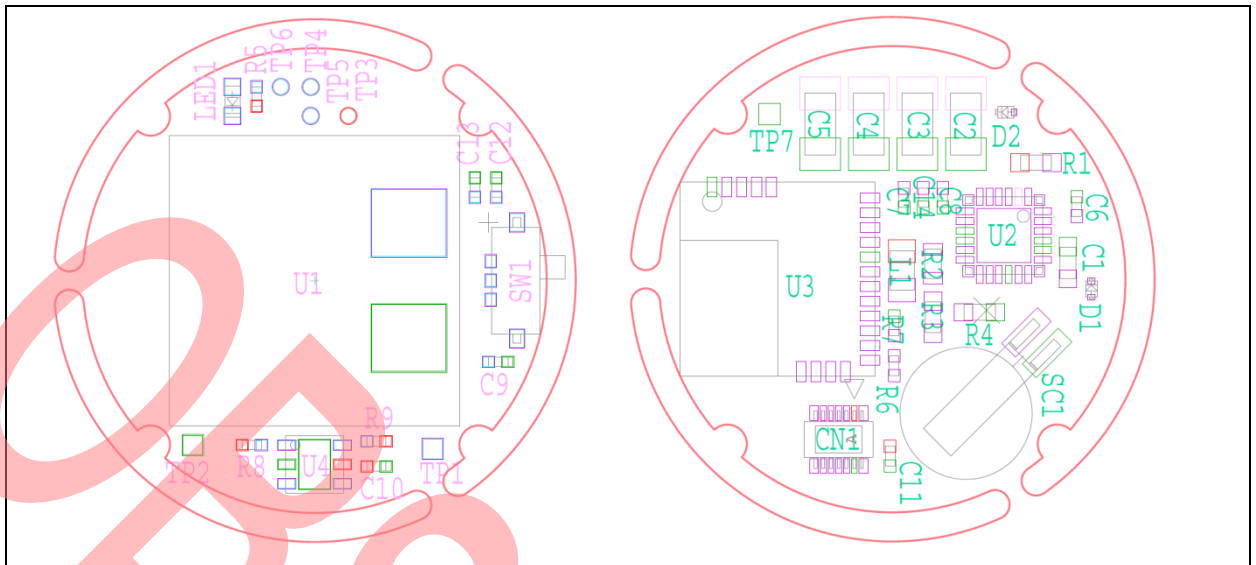
Figure 6-1. Solar BLE Sensor Block Diagram



Note that the Solar BLE Sensor is not printed the silk screen of all components due to tiny size. To identify the components, refer to the assembly drawing shown in Figure 6-2.

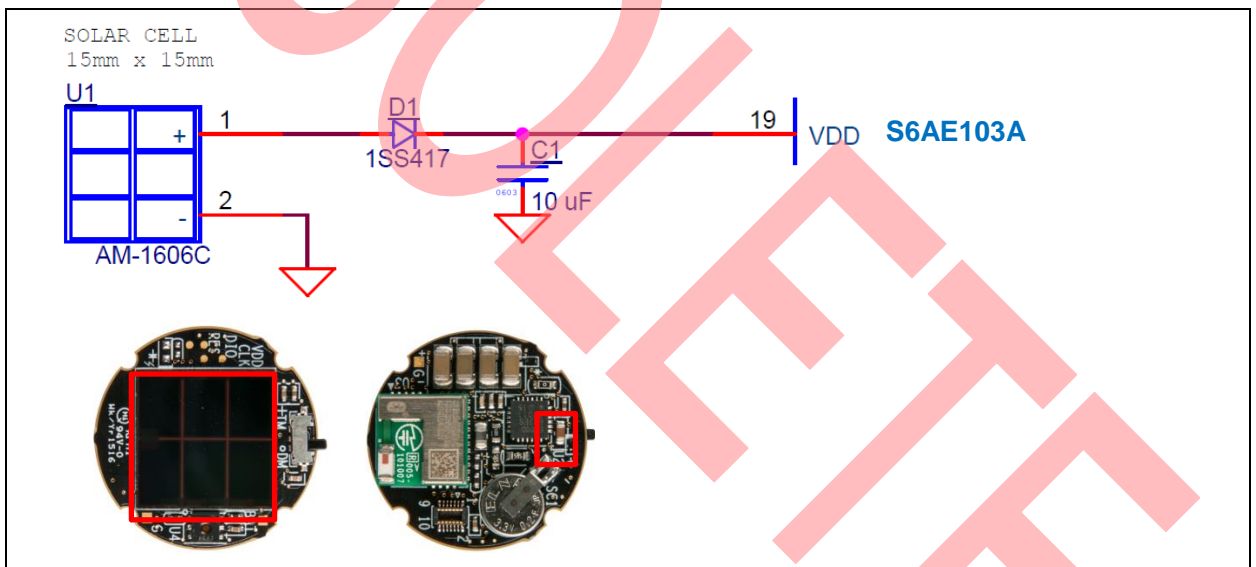


Figure 6-2. Solar BLE Sensor Assembly Drawing



### 6.1.1 15 x 15 mm Solar Cell

The solar cell connects to the VDD pin of S6AE103A via a diode for reverse current protection and via a 10- $\mu$ F capacitor as shown in the following.



The following are the design specifications of the solar cell (AM-1606C).

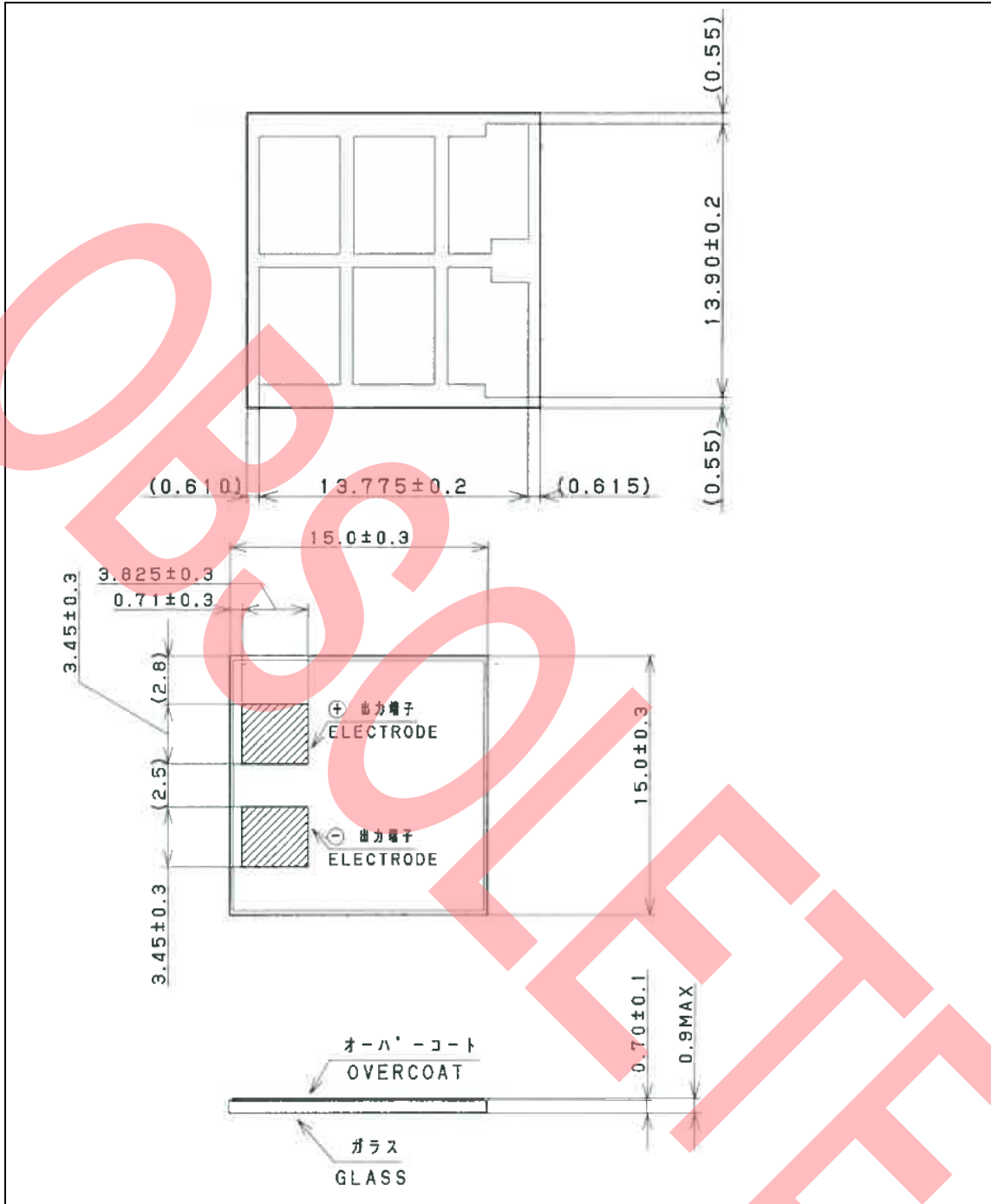


Table 6-1 lists the specifications of the solar cell (AM-1606C).

Table 6-1. Specifications of Solar Cell (AM-1606C)

Items	Specifications
Size	15.0mm × 15.0mm × 0.7mm
Open Circuit Voltage: $V_{oc}$	Typical 3.6 V (at 200Lux FL, 25°C)
Short Circuit Current: $I_{sc}$	Typical 3.5 $\mu$ A (at 200Lux FL, -25°C)

Items	Specifications
Operating Voltage and Operating Current: $V_{OPE} - I_{OPE}$	Typical 2.6V -3.1 $\mu$ A (at 200Lux FL, 25°C)
Working Temperature	-10 ~ 60°C
Storage Temperature	-20 ~ 70°C
Working Illuminance	~ 1000Lux

### 6.1.2 Energy Harvesting PMIC

Refer to [5.1 Hardware Description](#) for detailed specifications.

### 6.1.3 400- $\mu$ F Storage Capacitor

Refer to [5.1.3 Storage and VOUT Control Block](#) for detailed specifications.

### 6.1.4 0.2-F Supercapacitor

Refer to [5.1.3 Storage and VOUT Control Block](#) for detailed specifications.

### 6.1.5 Slide Switch for S6AE103A Mode Select

Refer to [Internal Timer Setting Block](#) for detailed specifications.

### 6.1.6 EZ-BLE ProC Module

EZ-BLE ProC modules are fully integrated, fully certified, programmable modules that are designed for ease of use. The module contains Cypress's ProC 4 BLE chip, two crystals, a chip or trace antenna, a shield, and passive components. Following is a schematic for the EZ-BLE ProC module. [Table 6-2](#) lists the module pins and their descriptions.

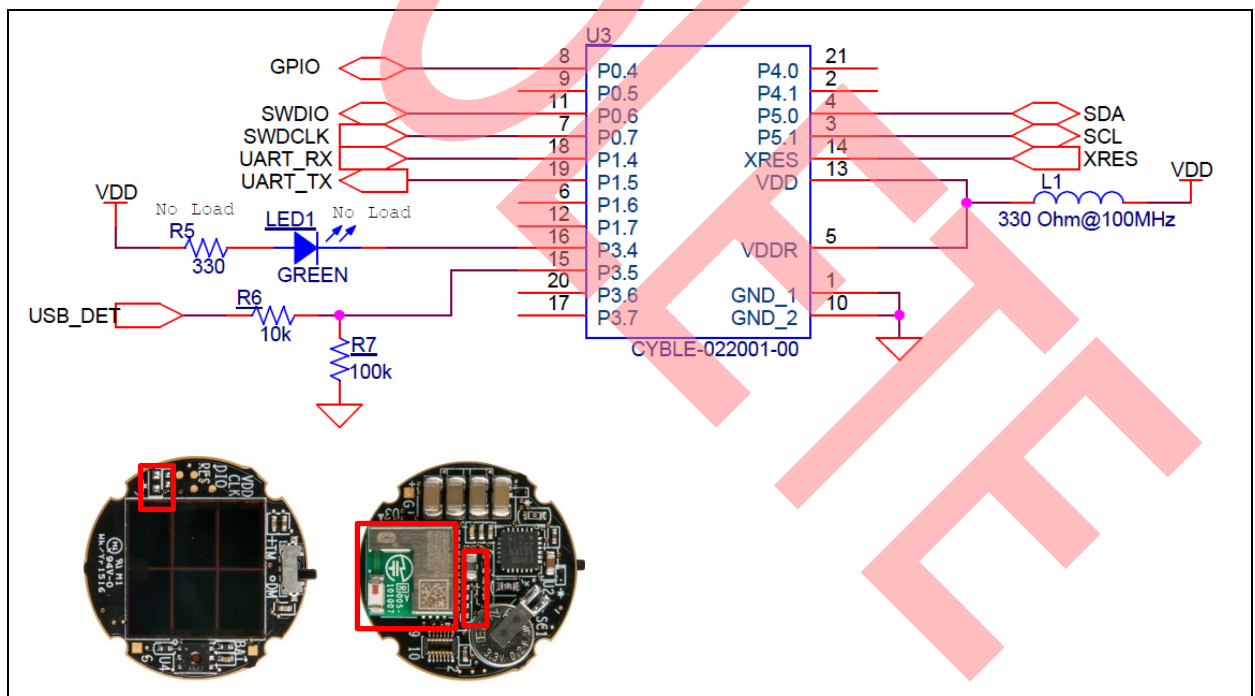
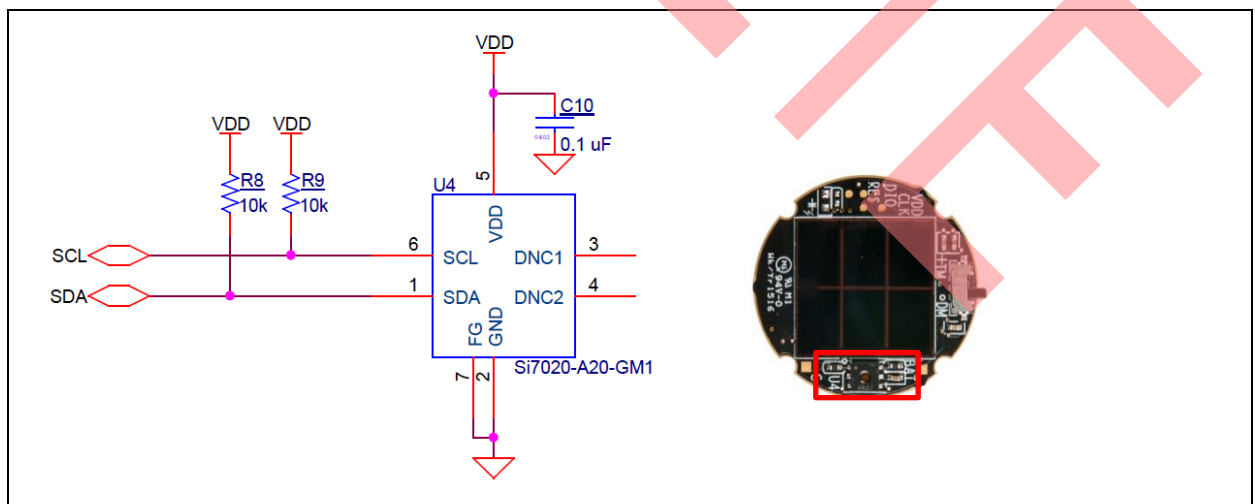


Table 6-2. Pin Description of EZ-BLE ProC Module

Pin Name	I/O	Description
P0.4	I/O	Connect CN1.9 pin Extra GPIO to connect Debug Board
P0.6	I/O	Connect CN1.4 pin SWDIO to program/debug via KitProg
P0.7	I	Connect CN1.3 pin SWDCLK to program/debug via KitProg
P1.4	I	Connect CN1.7 pin UART_RX to control the parameter via KitProg
P1.5	O	Connect CN1.8 pin UART_TX to control the parameter via KitProg
P3.4	O	Connect LED (not mounted) Extra user LED
P3.5	I	Connect CN1.6 pin USB detect from Debug Board
P5.0	I/O	Connect U4 of temperature and humidity sensor SDA for I <sup>2</sup> C connection
P5.1	I/O	Connect U4 of temperature and humidity sensor SCL for I <sup>2</sup> C connection
XRES	I	Connect CN1.5 pin XRES to program/debug via KitProg and reset pin
VDD	-	Connect VDD via L1 ferrite bead Digital power supply input
VDDR	-	Connect VDD via L1 ferrite bead Radio power supply
GND_1, GND_2	-	Ground connection
P0.5, P1.6, P1.7, P3.6, P3.7, P4.0, P4.1	-	Open Not used

### 6.1.7 Temperature and Humidity Sensor

The temperature and humidity sensor is a monolithic CMOS IC that integrates sensor elements, an analog-to-digital converter, signal processing, calibration data, and an I<sup>2</sup>C interface. The EZ-BLE ProC module controls the sensor IC via the I<sup>2</sup>C interface. The following is the schematic for the temperature and humidity sensor.



### 6.1.8 10-Pin Connector on Solar BLE Sensor

The 10-pin connector connects the Debug Board to program/debug, control parameters, detect USB connection, and charge the supercapacitor and supply power. The following is the schematic for the 10-pin connector. Table 6-3 gives the pin descriptions.

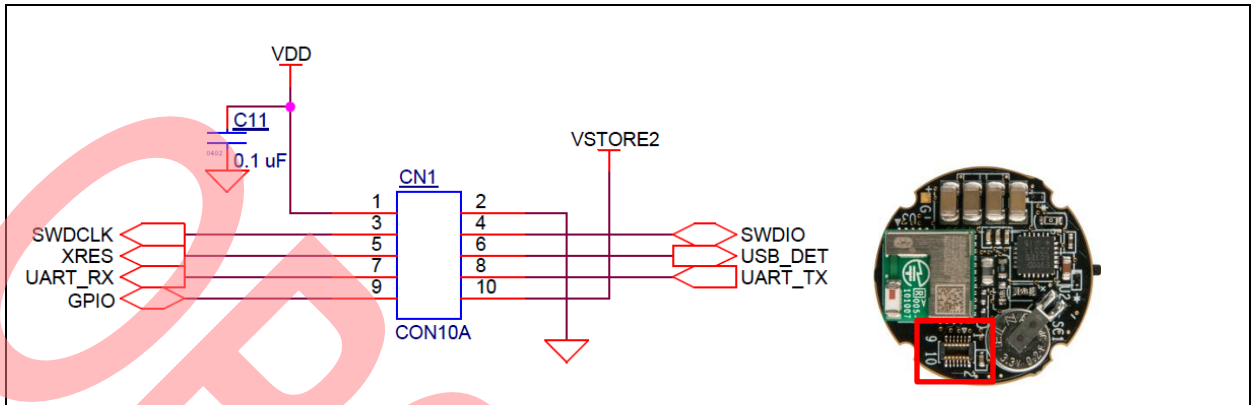


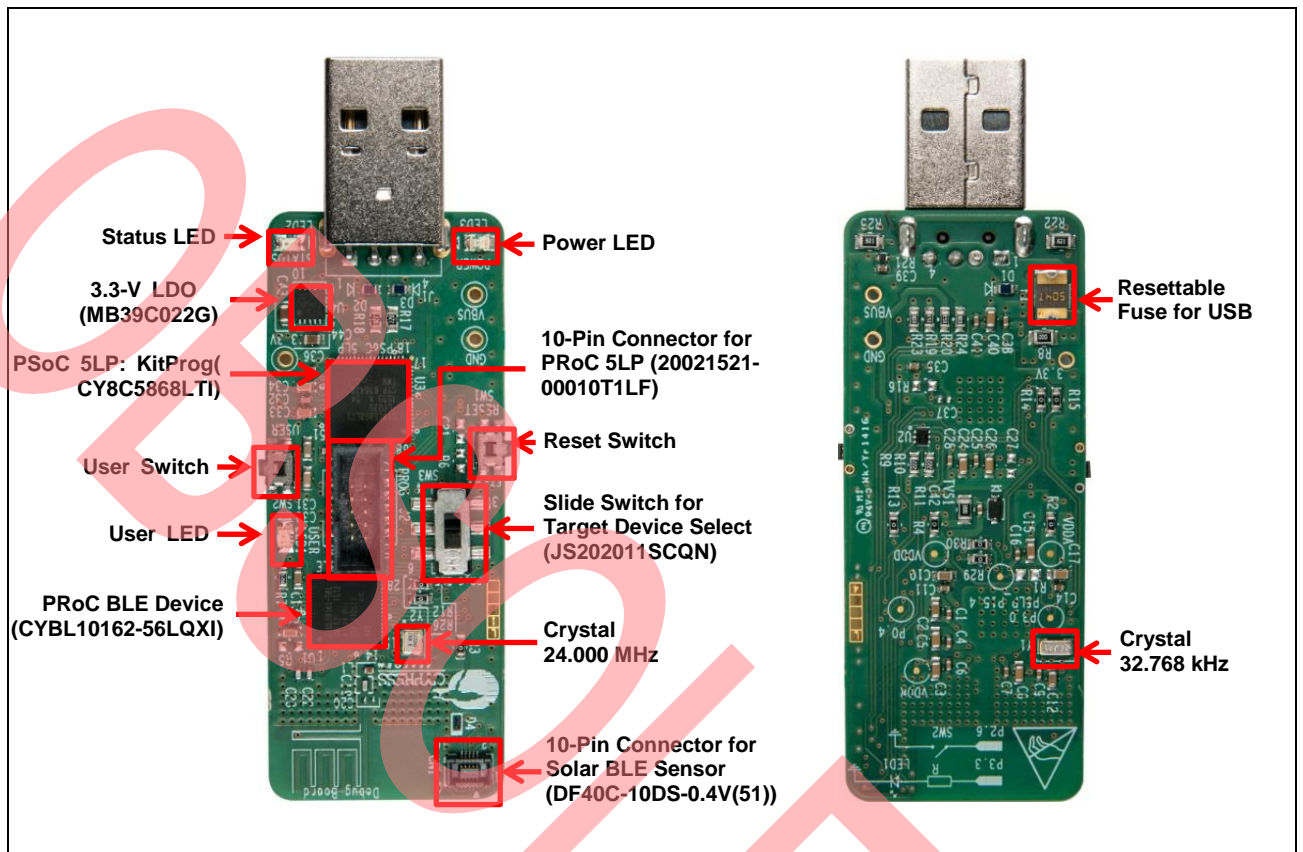
Table 6-3. Pin Description of 10-Pin Connector

Number	Name	Description:
1	VDD	Connect power of Solar BLE Sensor 3.3-V power from Debug Board
2	GND	Ground connection
3	SWDCLK	Connect P0.7 of EZ-BLE SWDCLK to program/debug via KitProg
4	SWDIO	Connect P0.6 of EZ-BLE SWDIO to program/debug via KitProg
5	XRES	Connect XRES of EZ-BLE XRES to program/debug via KitProg and reset pin
6	USB_DET	Connect P3.5 of EZ-BLE USB detect via divider resistor
7	UART_RX	Connect P1.4 of EZ-BLE UART_RX to control the parameter via KitProg
8	UART_TX	Connect P1.5 of EZ-BLE UART_TX to control the parameter via KitProg
9	GPIO	Connect P0.4 of EZ-BLE Extra GPIO to connect Debug board
10	VSTORE2	Connect VSTORE2 of S6AE103A To charge the supercapacitor using 3.3 V of Debug Board

## 6.2 Debug Board

The Debug Board consists of the blocks shown in Figure 6-3.

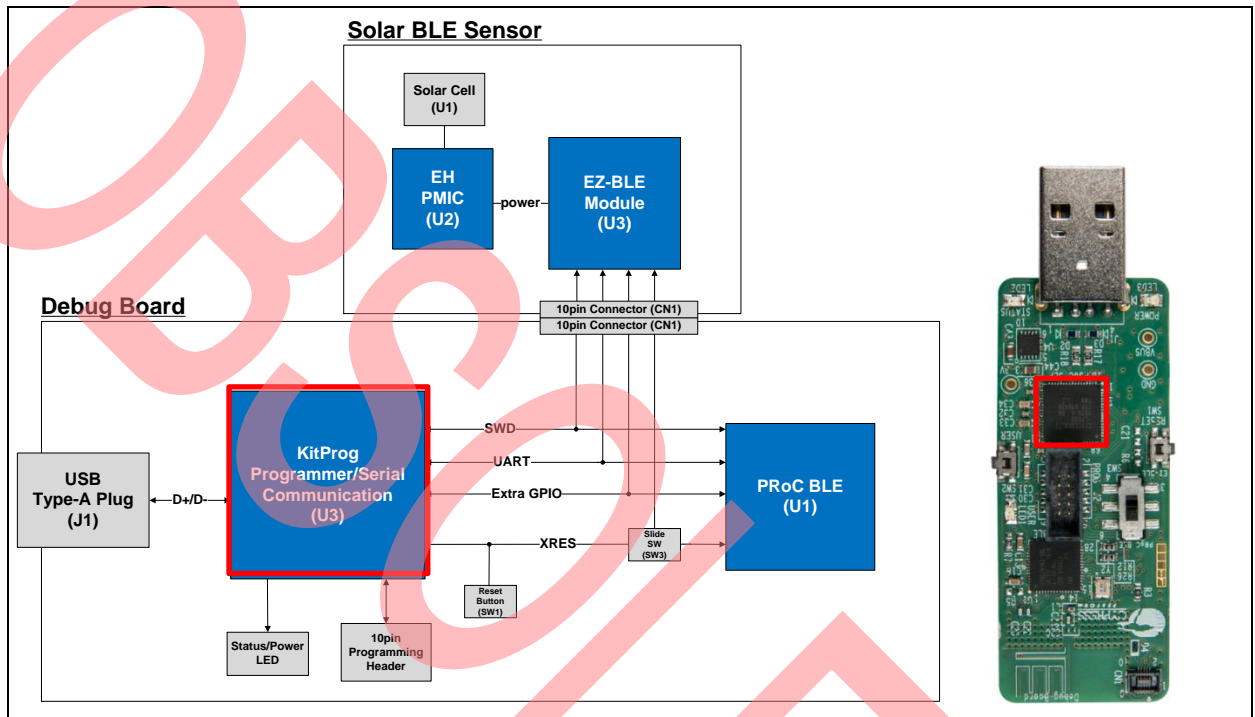
Figure 6-3. Debug Board Block Diagram



### 6.2.1 PsoC 5LP (KitProg)

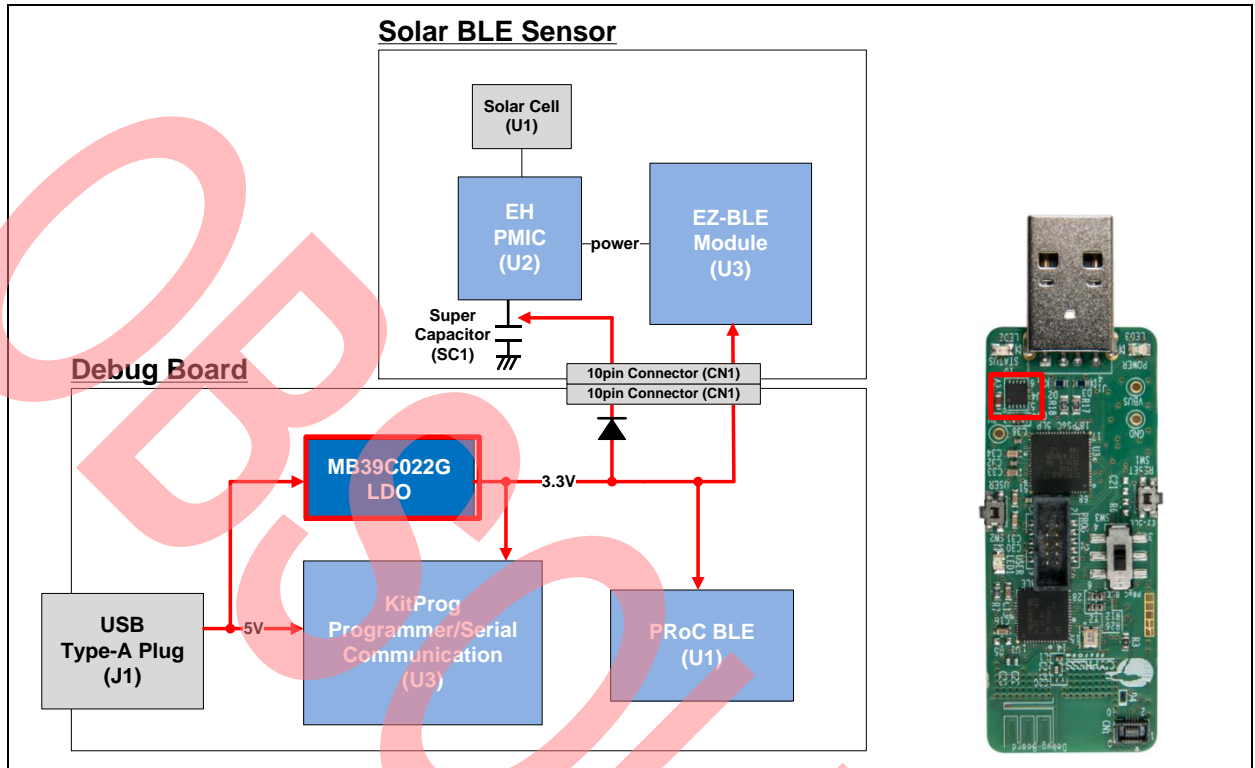
KitProg is the hardware/firmware block for onboard programming, debugging, and bridge functionality. It is a common reusable hardware/firmware block used across many Cypress kit platforms. It consists of a PsoC 5LP device, which connects to the computer over a USB interface and connects to the ProC 4 BLE device on the Debug Board or EZ-BLE module on the Solar BLE Sensor over the SWD, I<sup>2</sup>C, and UART pins.

The KitProg communicates with the PsoC Programmer and PsoC Creator software to program/debug the target ProC 4 BLE or EZ-BLE module over the SWD interface. The main advantage of an onboard programmer/debugger is that users do not have to buy extra programmer/debugger hardware. Refer to 4. [Program and Debug](#) to learn how to program/debug using KitProg. Following is the block diagram for KitProg.



### 6.2.2 Power System

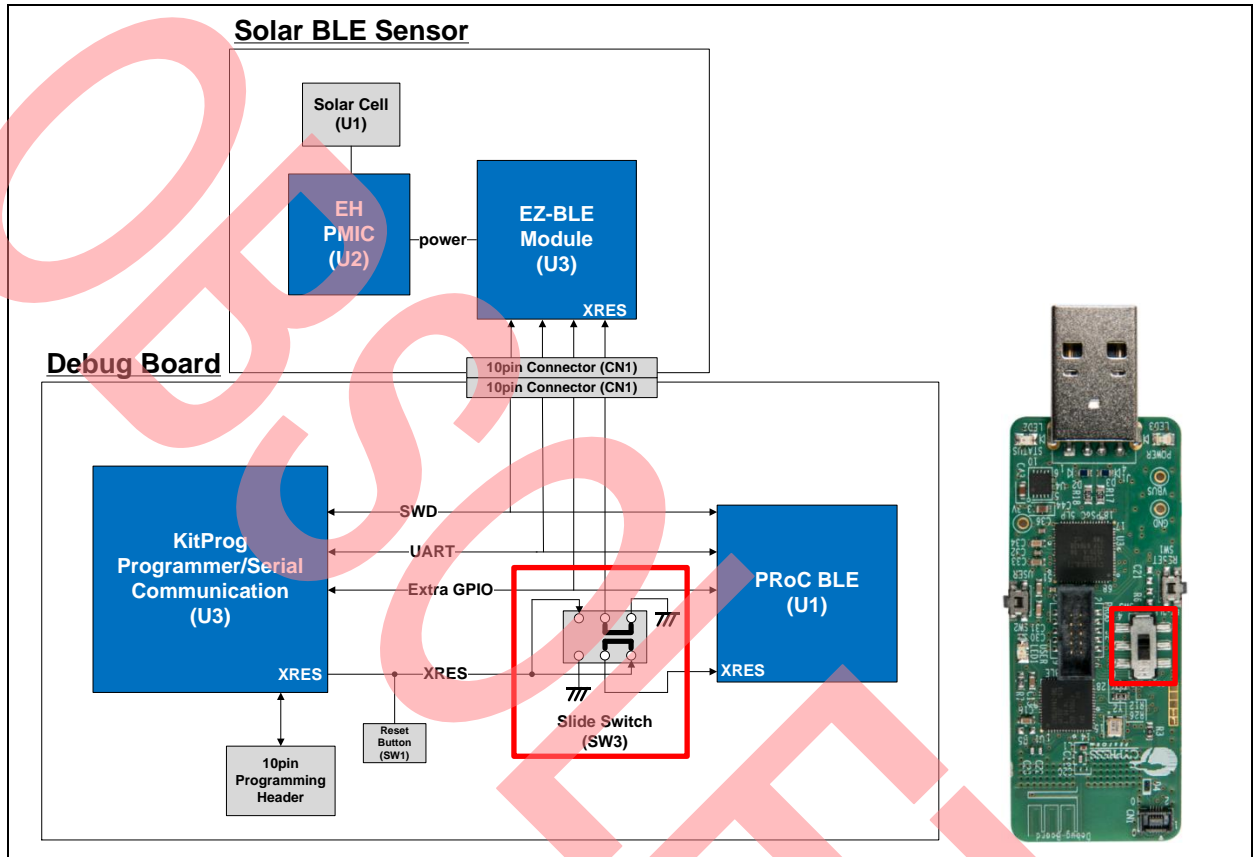
The power supply on the Debug Board is input from the USB Type-A Plug. A MB39C022G LDO is used to provide a 3.3-V output for each device. A supercapacitor (SC1) on the Solar BLE Sensor is charged via diode when the Solar BLE Sensor connects. The following is the block diagram for the power system.





### 6.2.3 Slide Switch for Target Device Select

This section describes the slide switch implementation on the Debug Board, as shown in the following block diagram. The slide switch selects the target device to program and control using the XRES pin. When the switch is set to “ProC BLE Program mode,” the PsoC 5LP XRES pin connects the ProC BLE device, and the XRES of the EZ-BLE module connects to ground. When the switch is set to “EZ-BLE Program mode,” the PsoC 5LP XRES pin connects the EZ-BLE module, and the XRES of the ProC BLE device connects to ground.



### 6.2.4 10-Pin Connector on Debug Board

The 10-pin connector connects the Solar BLE Sensor to program/debug, control parameters, detect USB connection, charge the supercapacitor, and supply power. The following is the schematic for the 10-pin connector. Table 6-4 provides the pin names and descriptions for the 10-pin connector.

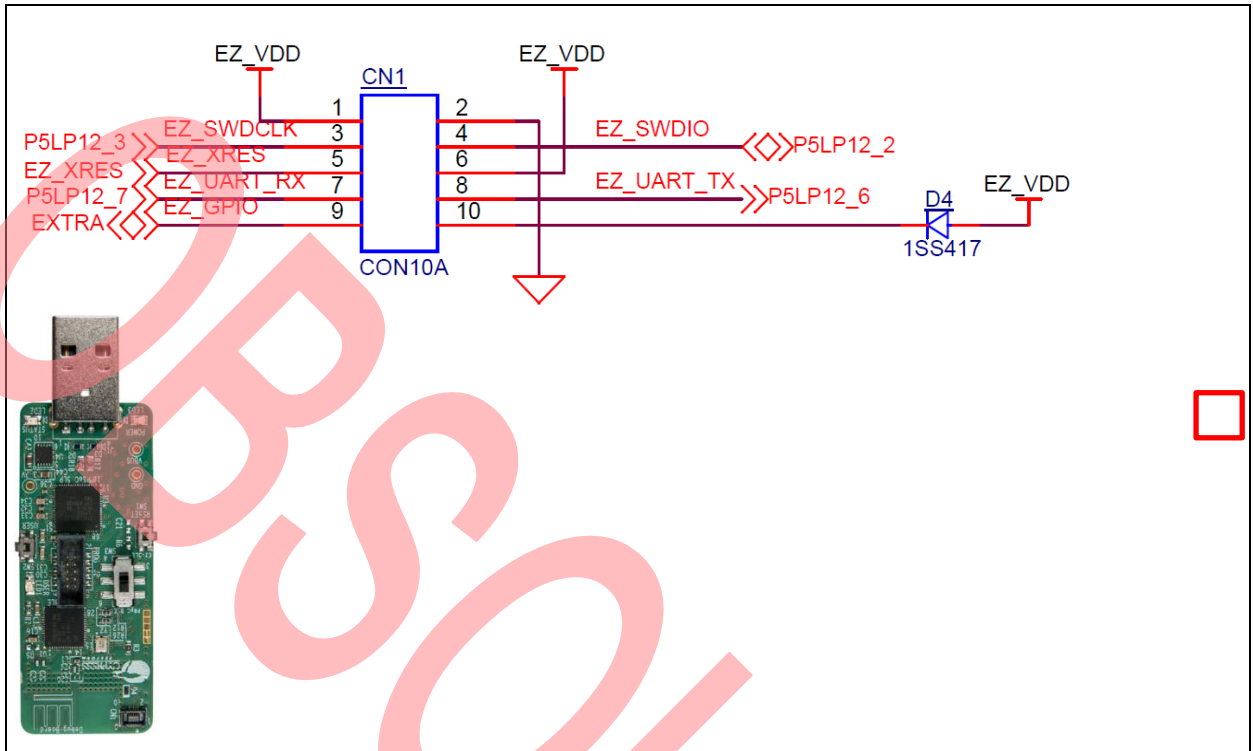


Table 6-4. Pin Description of 10-Pin Connector

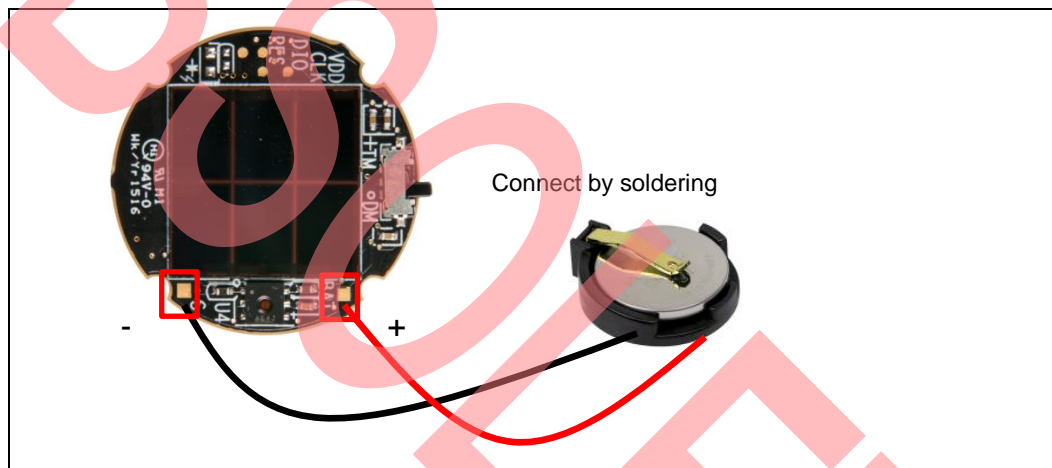
Number	Name	Description
1	EZ_VDD	Connect the 3.3-V output of the LDO 3.3-V power to Solar BLE Sensor
2	GND	Ground connection
3	SWDCCLK	Connect P12.3 of PsoC 5LP SWDCCLK to program/debug via KitProg
4	SWDIO	Connect P12.2 of PsoC 5LP SWDIO to program/debug via KitProg
5	XRES	Connect XRES of PsoC 5LP XRES to program/debug via KitProg and slide switch
6	EZ_VDD (USB_DET)	Connect 3.3-V output of the LDO To detect USB connection
7	UART_RX	Connect P12.7 of PsoC 5LP UART_RX to control the parameter via KitProg
8	UART_TX	Connect P12.6 of PsoC 5LP UART_TX to control the parameter via KitProg
9	GPIO	Connect P15.4 of PsoC 5LP Extra GPIO to connect Solar BLE Sensor
10	EZ_VDD (VSTORE2)	Connect 3.3-V output of the LDO via diode To charge the supercapacitor on Solar BLE Sensor

# Appendix A. Advanced Topics



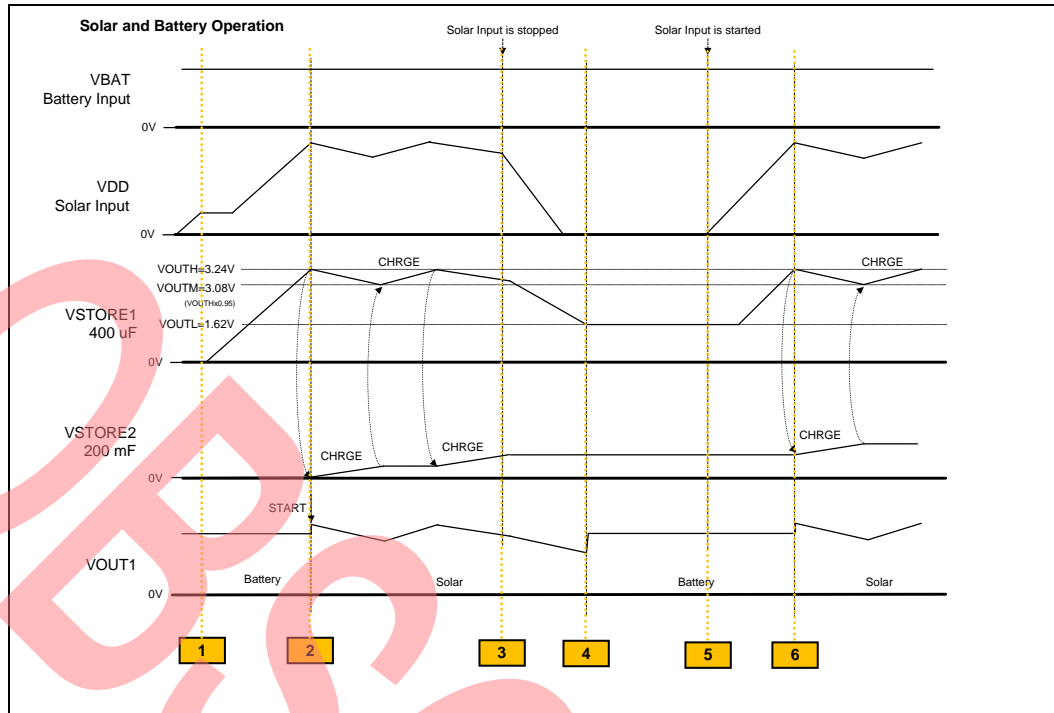
## A.1 Battery Input Operation

The Solar BLE Sensor has an extra test pad for primary battery input as shown in the following figure. It can connect a primary battery (not included in the kit) such as a 3-V coin type using test pads. Use soldering to connect the battery to check the solar and battery operation.



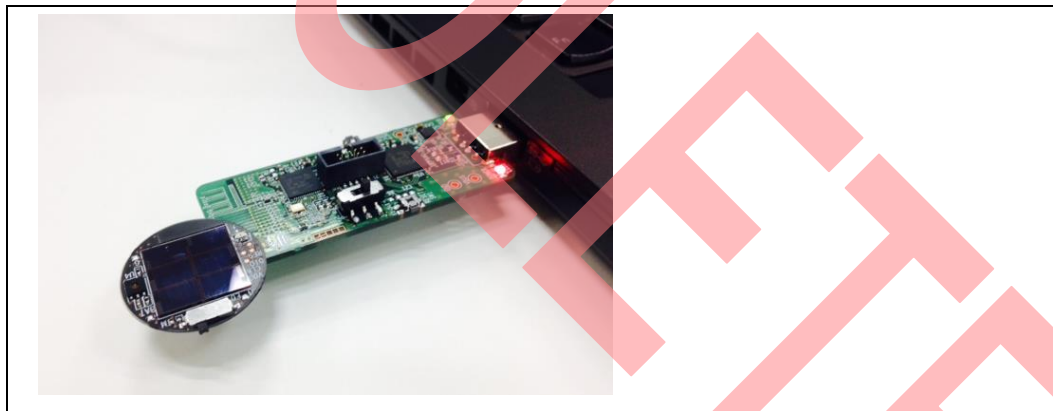
The following is the sample waveform. Note that this sample waveform is for the power gating operation mode of S6AE103A is in an “Energy Driven Mode”. Refer to the [S6AE103A datasheet](#) for detailed operation modes.

1. The solar input is started (VOUT1 = Battery).
2. The VOUT1 voltage changes to solar energy when the VSTORE1 achieves VOUTH (3.24 V).
3. The VSTORE1 decreases when the solar input is stopped (VOUT1 = Solar).
4. The VOUT1 voltage changes to battery when the VSTORE1 achieves VOUTL (1.62 V).
5. The VSTORE1 increases when the solar input is restarted (VOUT1 = Battery).
6. The VOUT1 voltage changes to solar energy when the VSTORE1 re-achieves VOUTH (3.24 V).

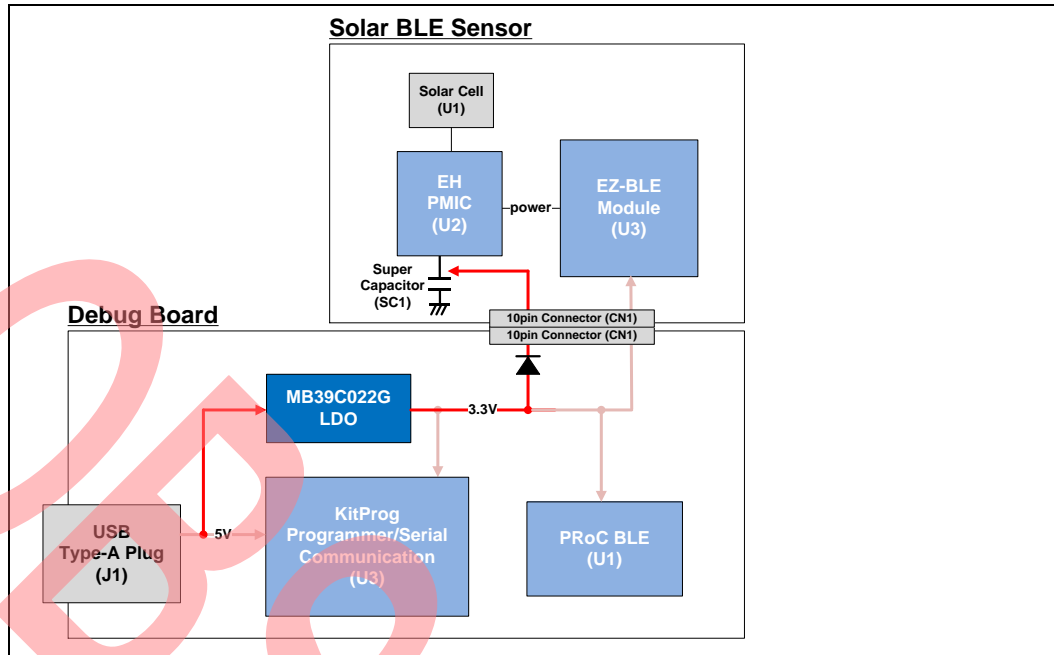


## A.2 Charging the Supercapacitor

The supercapacitor (SC1) on the Solar BLE Sensor is charged when the Solar BLE Sensor is connected to the Debug Board via USB. For example, the supercapacitor is charged half voltage from 0 V when it is connected via USB for two minutes or more. To fully charge, it needs ten minutes or more.

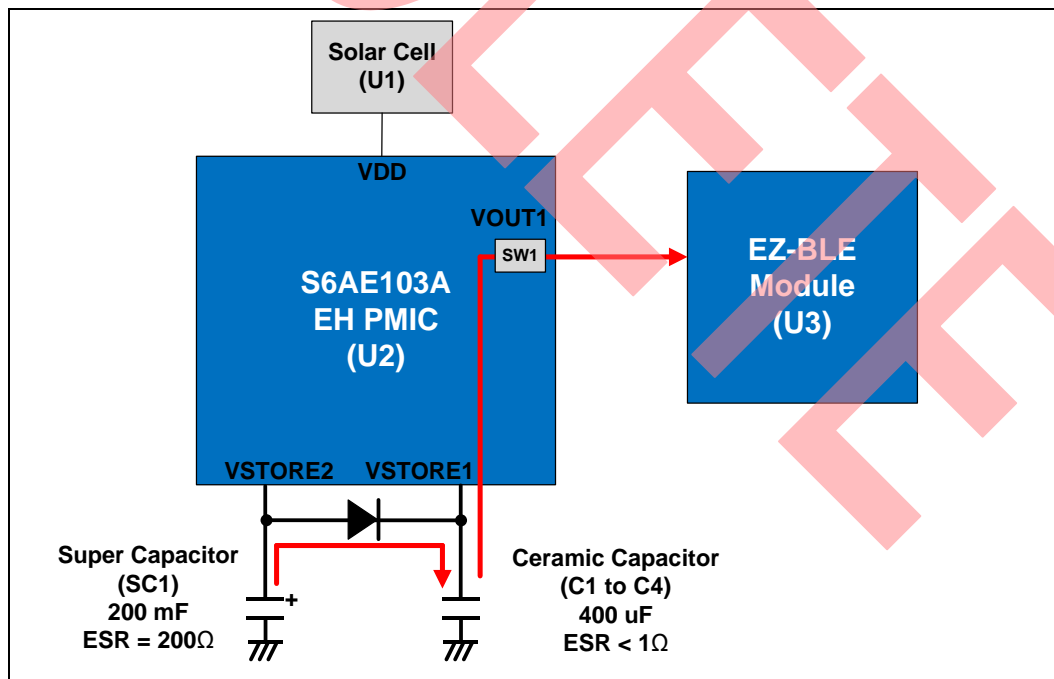


The following is the block diagram to charge the supercapacitor from USB.



### A.3 Equivalent Series Resistance of the Supercapacitor

The VOUT setting of S6AE103A is set as 3.24 V (VOUTH) to 1.62 V (VOUTL). There is a 0.28-V VOUTL margin to supply voltage to the VOUT load (operation voltage is 3.6 V to 1.9 V). This margin is for taking measures to mitigate the voltage drop because of equivalent series resistance (ESR). The ESR of the supercapacitor (C1) on the Solar BLE Sensor is 200 Ω. When the VOUT load current is 5 mA, the voltage drop will be 1000 mV ( $V = IR$ ). To resolve such a problem, the S6AE103A has two storage pins: VSTORE1 and VSTORE2. VSTORE1 connects the low-ESR capacitor, such as a ceramic capacitor. VSTORE2 connects the large capacitance such as the supercapacitor. The energy of the supercapacitor (VSTORE2) passes to the low-ESR capacitor (VSTORE1), and then the low-ESR capacitor supplies the energy to the VOUT load. This operation reduces the voltage drop.



A few voltage drops will still occur, however, because VOUT is supplied using only a ceramic capacitor when there is no solar energy. The kit connects the 400-μF capacitor to VSTORE1, and the energy of the BLE sensor transmission is about 200 μJ. If the VSTORE1 voltage is 1.9 V and it uses 200 μJ of energy, the voltage drop is about 0.28 V. Refer to the following equation.

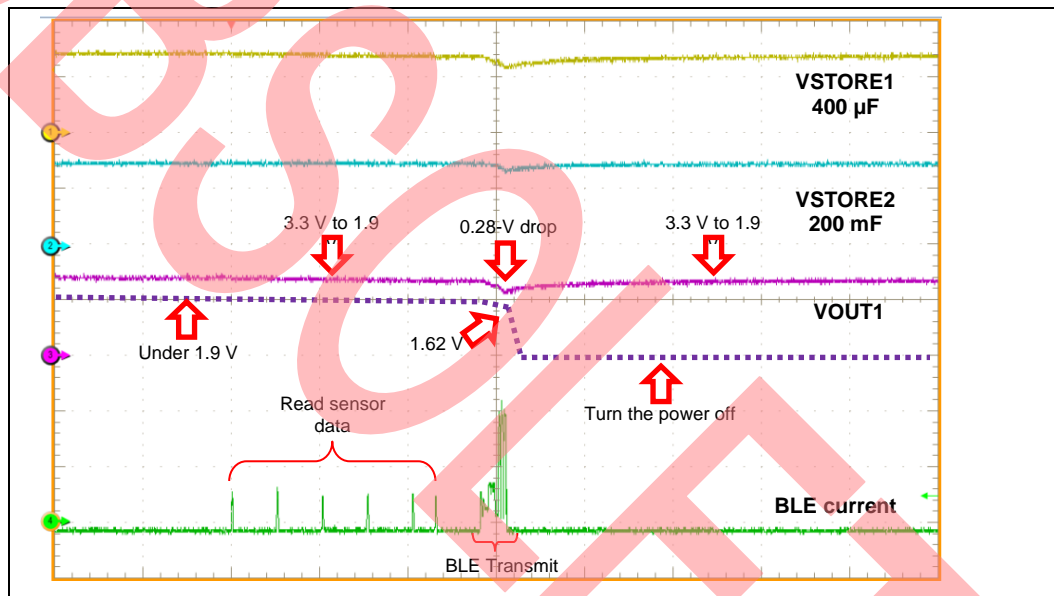
$$E = \frac{1}{2} \times C \times (VH^2 - VL^2)$$

$$VL = \sqrt{VH^2 - \frac{2 \times E}{C}} = \sqrt{1.9V^2 - \frac{2 \times 200\mu J}{400\mu F}} = 1.62V$$

$$Vdrop = VH - VL = 1.90V - 1.62V = 0.28V$$

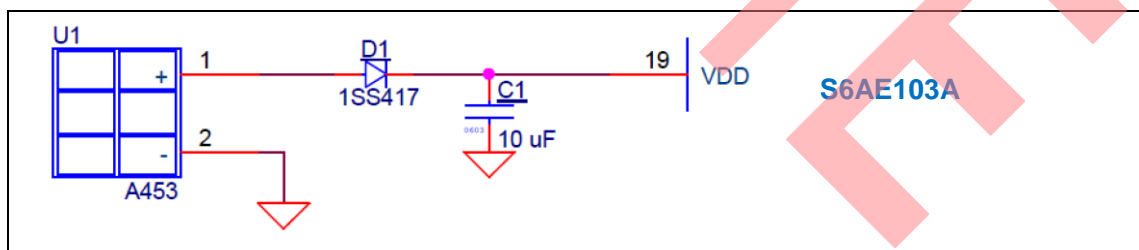
E = 200 [uJ]  
 C = 400 [uF]  
 VH = 1.9 [V]  
 VL = Voltage after drop  
 Vdrop = Drop voltage

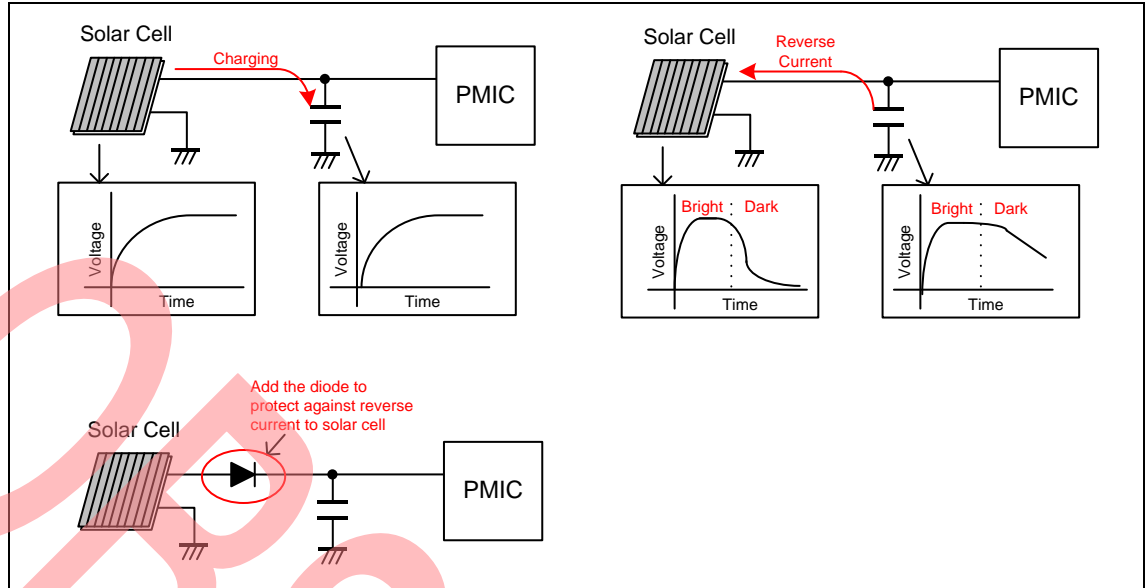
When the VOUT1 is 3.3 V to 1.9 V, S6AE103A constantly supplies the voltage. When the VOUT1 is under 1.9 V or reaches 1.62 V due to voltage drop, S6AE103A turns the voltage OFF and stops the BLE transmission.



#### A.4 Diode Connection Between Solar Cell and VDD

A diode is needed between the VDD pin and the solar cell to protect against reverse current from the input capacitor to the solar cell. When the ambient light level is suddenly dark, the input capacitor voltage will be higher than the solar cell voltage.



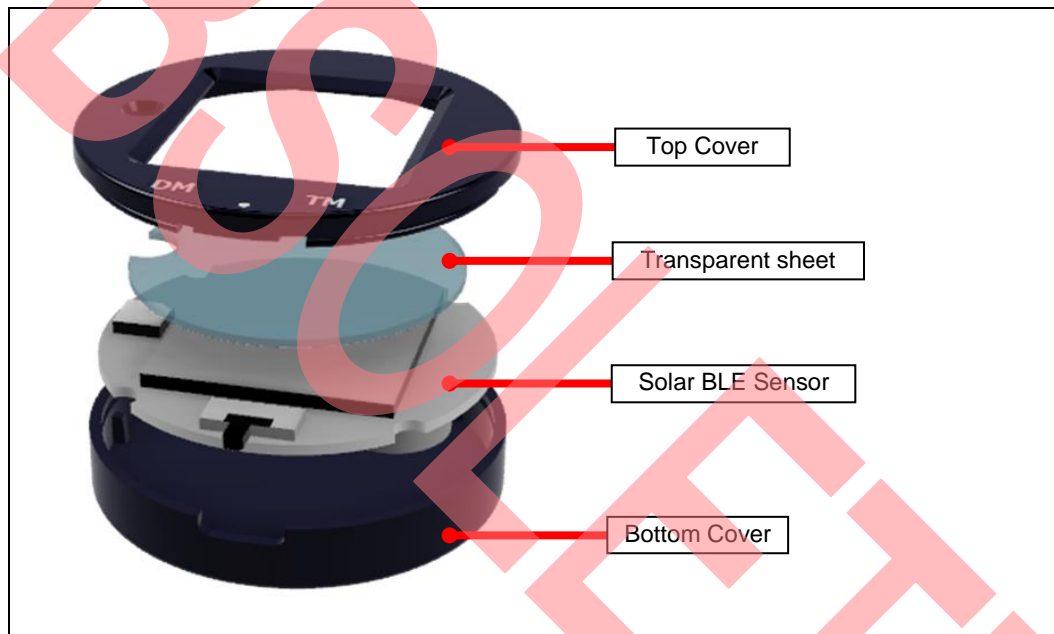


# Appendix B. Solar BLE Sensor Enclosure



## B.1 Solar BLE Sensor Enclosure

The kit includes an enclosure for the Solar BLE Sensor, shown in the following image. It contains three parts: a top cover, a bottom cover, and a transparent sheet for the solar cell.

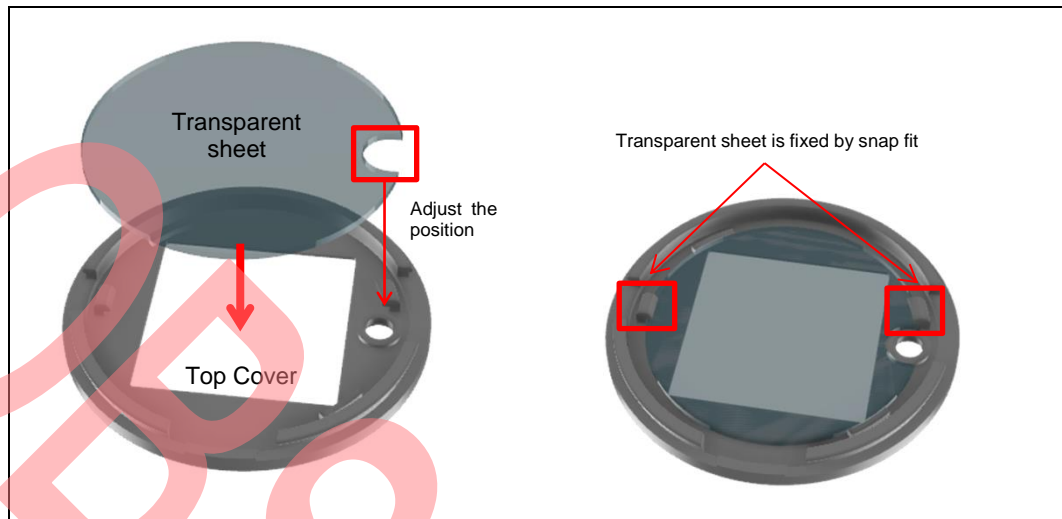




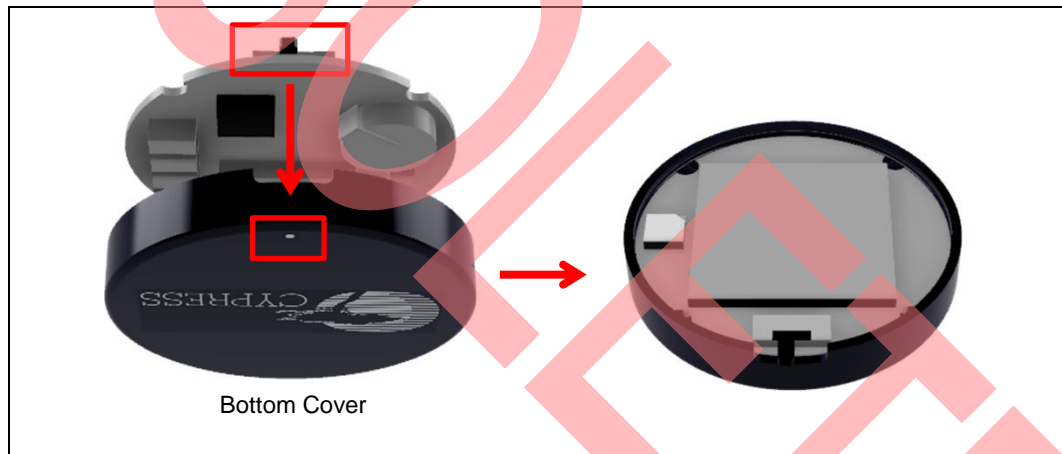
## B.2 How to Install the Board in the Enclosure

Use the following steps to install the Solar BLE Sensor board in the enclosure.

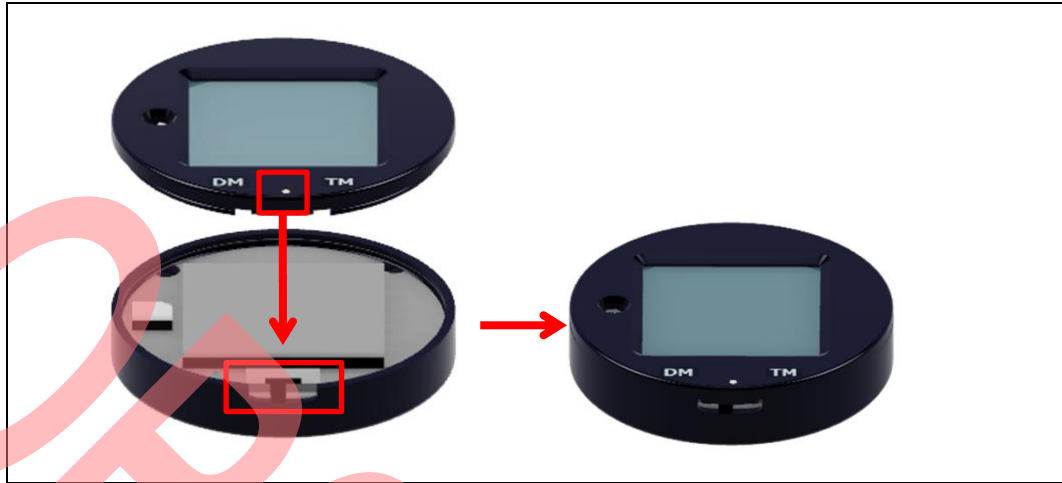
1. Set the transparent sheet to the top cover as shown below.



2. Adjust the position of the circle mark on the bottom cover and SW1 on Solar BLE Sensor. Put in the Solar BLE Sensor in the bottom cover.



3. Adjust the position of the circle mark on the top cover and SW1 on Solar BLE Sensor. Install the top cover to the bottom cover.



# Revision History



Document Title: CYALKIT-E02 Solar-Powered BLE Sensor Beacon Reference Design Kit Guide

Document Number: 002-11317

Revision	Issue Date	Origin of Change	Description of Change
**	04/28/2016	EIFU	Initial release
*A	06/01/2016	EIFU	Changed the order of Install Cypress BLE-Beacon Software. Changed the file location path of the Cypress BLE-Beacon. Added the copy step of the BLE folder in 4.2.2
*B	04/06/2017	EIFU	Updated Serial Command List section. Added Eddystone-URL Configuration Service section. Added Note about Validators section. Added Eddystone Format section. Updated to new template.
*C	06/01/2017	EIFU	Updated pictures of Cypress BLE-Beacon GUI. Added a note of firmware version 1.2.00
*D	03/28/2019	EIFU	Updated to new template. Completing Sunset Review.
*E	03/17/2022	EIFU	Obsolete document. Completing Sunset Review.