

# CLP0512DC Open Frame Power Supply

48Vdc Input; 12V/45.8A & 5V/1A Output; 550W Output Power



## Application

- Industrial equipment
- Telecommunications equipment
- Network Routers, Switches

## Features

- Compact size 76.2 mm x 152.4 mm x 35 mm (3 in x 6 in x 1.38 in) with density of 22.1 W/in<sup>3</sup>
- Universal DC Input Range (36 – 75VDC)
- Output voltage of 12V (adjustable  $\pm 5\%$ )
- Standby output of 5V @ 1A (standard versions)
- Maximum output current of 45.8A @ 12Vout (550W)
- High efficiency (92% at Full Load)
- 550W capability at 36V<sub>in</sub>, 50°C and 600LFM airflow with derating at higher temperatures or lower airflows
- 420W output at 36V<sub>in</sub>, for sealed enclosure applications, with enclosure outside surface at 55°C and enclosure inside ambient at 85°C.
- Reverse input voltage protection
- Output overcurrent protection (non-latching)
- Overtemperature protection
- Output overvoltage protection
- Minimum of 2ms of holdup time at 500W out
- Parallelable with output current sharing (option)
- Conducted EMI - meets CISPR22 (EN55022) and FCC Class B requirements
- Meets IEC61000-4-5, Level 4 (1kV/1kV)
- Compliant to RoHS II EU “Directive 2011/65/EU”
- UL and cUL approved to UL/CSA62368-1, TUV (EN62368-1), CE Mark (for LVD) and CB Report available
- ISO\*\* 9001 and ISO 14001 certified manufacturing facilities
- Conformal Coating (required for initial customer deployment, optional for later standard product)

## Features

In a small 3 x 6 inch footprint, the 12Vdc single-output CLP0512DC open frame power supply delivers 92% typical power efficiency. With its small size, the CLP series is specifically designed to handle power challenges associated with tight space and low airflow. Offering a high 22.1W/in<sup>3</sup> power density in a 1U high, fan-less form factor, the CLP series addresses a broad range of applications in new products from industrial equipment and communications original equipment manufacturers (OEMs). Higher temperature operation is possible at derated output. Protection features include overcurrent (OCP), overvoltage (OVP), and overtemperature (OTP).

# Technical Specifications

## Absolute Maximum Ratings

Stresses in excess of the absolute maximum ratings can cause permanent damage to the device. These are absolute stress ratings only, functional operation of the device is not implied at these or any other conditions in excess of those given in the operations sections of the data sheet. Exposure to absolute maximum ratings for extended periods can adversely affect the device reliability.

Parameter	Device	Min	Max	Unit
Input Voltage - Continuous	All	36	75	Vdc
Operating Ambient Temperature	All	-40	85	°C
In sealed enclosure applications with thermally conductive pad to enclosure, $P_{O,max} = 550$ W	All	-40	65	°C
Storage Temperature	All	-40	85	°C
Humidity (non-condensing)	All	5	95	%
Altitude	All		5000	m
Isolation Voltage – Input to output	All		1000	Vdc

## Electrical Specifications

Parameter	Device	Min	Typ	Max	Unit
Operating Input Voltage	All	36	48	75	Vdc
Input Current	All			18	A
Inrush Transient Current ( $V_{IN} = 48$ Vdc, $T_{amb} = 25$ °C)	All			60	A Peak
Leakage Current to earth ground ( $V_{IN} = 48$ Vdc)	All			3.5	mA
Output Voltage Setpoint	All		12		Vdc
Output Voltage Tolerance (due to set point, temperature variations, load and line regulation)	All	-2		2	%
Output Voltage Adjustment Range	All	11.4		12.6	Vdc
Output Remote Sense Range	All			250	mVdc
Output Load Regulation	All			1	%Vout
Output Line Regulation	All			0.5	%Vout
Output Ripple and Noise – measured with 0.1µF ceramic capacitor in parallel with 470µF polymer capacitor	All			240	mV p-p
Peak-to-peak (20MHz Bandwidth)					
Dynamic Load Response – 50% to 100% load transient, 1A/µs slew rate					
Output voltage deviation	All			5%	%
Settling Time	All			500	µs
Output Current	All	0		45.8	Adc
Output Current Limit Inception	All	110		145	% $I_{O,max}$
Maximum Output Capacitance	All			10000	µF
Standby Output Voltage	All		5		Vdc
Standby Output Current	All			1	Adc
Efficiency: $V_{IN} = 48$ Vdc, 50% load	All	92.0	-	-	%
Holdup Time – 100% load ( $V_{out} \geq 10.8V_{DC}$ , $T_{amb} = 25$ °C, 500W, $V_{IN} =$ full range)	All	2			ms

## General Specifications

Parameter	Device	Symbol	Typ.	Unit
Calculated Reliability based on Telcordia SR-332 Issue 2: Method 1 Case 3 ( $V_{IN}=48$ Vdc, $I_o = 37$ A, $T_A = 40$ °C, airflow 200LFM, 90% confidence)	All	MTBF	>750,000	Hours
Weight	All		346 12.2	g oz.

# Technical Specifications

## Feature Specifications

Parameter	Device	Min	Typ	Max	Unit
On/Off Signal Interface – signal referenced to GND					
Logic Low (Power Supply ON)					
Input Low Current	All			0.2	mA
Input Low Voltage	All			0.5	V
Logic High (Power Supply OFF)					
Input High Current	All			1.1	mA
Input Voltage	All	3.5		13	V
Delay from ON/OFF being enabled to start of output voltage rise	All			50	ms
Output Voltage Rise Time (from 10 to 90% of final value)	All		20		ms
Delay from Input being applied to all outputs being in regulation	All		2		s
Output Overvoltage Protection	All	13.8		16	Vdc
Input Undervoltage lockout					
Turn-on Threshold (100% load)	All	33	35	36	Vdc
Turn-off Threshold (100% load)	All	32	33	35	Vdc
DC OK – open collector, High when output available					
Sink Current	All			4	mA
Maximum Collector Voltage	All			12	V

## Environmental Specifications

Parameter	Device	Specification/Test
Radiated Emissions	All	CISPR22 Class B with 3dB margin
Conducted Emissions	All	CISPR22 Class B with 6dB margin
ESD	All	IEC61000-4-2, Level 4 Performance Criteria A
Radiated Susceptibility	All	IEC61000-4-3, Level 3
Electrical Fast Transient Common Mode	All	IEC61000-4-4, Level 3
Surge Immunity	All	IEC 61000-4-5; $\pm 1$ kV common mode and differential mode, unit passes criteria A (normal performance; impedance is 2 Ohms for differential and common mode.)
Conducted RF Immunity	All	IEC61000-4-6, Level 3
Voltage Dips, Interruptions	All	-53V <sub>in</sub> , 80% load, Dip 100% duration 2ms, Criteria (A)
Shock and Vibration	All	Per IPC-9592B, Class II

## Safety Specifications

Parameter	Device	Specification
Dielectric Withstand Voltage (between input and output)	All	Minimum of 1500Vdc for 1 minute
Insulation Resistance (between input and output)	All	Minimum of 5 MW
Safety Standards	All	Class 1, IEC62368-1, EN62368-1, with the following deviations: Nemko, UL 62368-1 (Recognized Component), cUL (Canadian Approval by UL)

# Technical Specifications

## Safety Considerations

The CLP0512DC embedded power supply is intended for inclusion in an end product equipment and shall be installed in compliance with the enclosure, mounting, spacing, casualty and segregation requirements of the end-use application. A suitable Electrical and Fire enclosure shall be provided and is not intended to be operated as a stand-alone product. It is cURus, TUV approved using the applicable requirements for Safety of Information Technology Equipment.

## Feature Descriptions

### Standby Power Supply

A standby output of 5V in the CLP0512DC power supply comes up when DC input in the operating range is applied.

### Remote On/Off

The CLP0512DC power supply features a TTL-compatible On/Off control input. The power supply turns ON when the On/Off input goes low, and turns OFF when the input goes high. Note that if the On/Off pin is left unconnected, the power supply main output will turn ON when DC input is present.

### Output Voltage Adjustment

For all units, the output voltage can be adjusted between 11.4V and 12.6V using a potentiometer on the power supply.

### Remote Sense

For all versions, the power supply has both positive and negative remote sense connections that can be connected to the positive and negative rails of the main output near the load. The power supply operates even without the remote sense connections being made.

### Overcurrent Protection

To provide protection in a fault condition (output overload), the power supply is equipped with internal current-limiting circuitry and can endure current limiting continuously. At the point of current-limit inception, the unit enters hiccup mode. The power supply operates normally once the output current is brought back into its specified range.

### Overvoltage Protection

Overvoltage protection is a feature of the CLP0512DC power supply that protects both the load and the power supply from an output overvoltage condition. When an overvoltage occurs, the power supply shuts down and latches off until the overvoltage condition is removed. It is necessary to recycle the input to restart the power supply when this protection is activated.

### Reverse Input Voltage Protection

Reverse Input Voltage Protection is a feature of the CLP0512DC power supply that protects the power supply from damage if a reverse voltage is applied to the input.

### Overtemperature Protection (OTP)

For additional protection in a fault condition the CLP0512DC is equipped with a thermal shutdown circuit which detects excessive internal temperatures and shuts the unit down. Once the power supply goes into overtemperature shutdown, it will cool before attempting to restart.

### Input Undervoltage Lockout

At input voltages below this limit, power supply operation is disabled. The power supply will begin to operate at an input voltage above the undervoltage lockout turn-on threshold

### DC OK

The CLP0512DC provides a DC OK signal that indicates when the output has come up and is in regulation. This is a pull up type signal that goes high when the output is available and within regulation.

### Power Good LED

A green LED on board the power supply illuminates when the main output voltage is above 10V.

### Paralleling with Active Output Current Sharing

For modules with this option, paralleling of up to 4 power units is supported. Current sharing of multiple units is implemented by connecting the Parallel pins together and connecting identical output voltage and remote sense polarity pins of the modules together at the load. At load current levels above 20%, the output currents of multiple power supplies are within  $\pm 5\%$  of the full load value. When not using this feature, paralleling pins should be left unconnected.

- Current share signals of each power supply must be connected.
- An external ORing function needs to be employed at the Vout (+) signal. An ORing diode or a MOSFET & controller scheme can also be used.
- The 5V Standby Return SHOULD NEVER be connected with the VOUT-(RETURN) signal. 5V stdby returns will need to be connected together, the 5V stdby Vout(+) leg remain separate. The 5V stdby output is not designed to be paralleled, and other considerations must be made if this operation is desired. Please contact your ABB sales rep for FAE involvement for further discussion.
- Hot drag of VOUT- when paralleling with load is not acceptable.

# Technical Specifications

## Assembling

- Please use metal screws size UNC#6-32 (see Fig. 1) to mount the unit and make sure the 5 mounting holes are connected to Earth well.
- In applications where the power supply is enclosed, special attention to clearances between the supply and the enclosure should be a min. Of 3.5mm on all sides. For additional protection, a layer of Kapton tape, 3 mil in thickness covering the whole surface under the power supply is recommended. If a cover is used, a 3 mil Kapton tape covering the whole area is also recommended. Please contact your local ABB FAE if further information is needed.

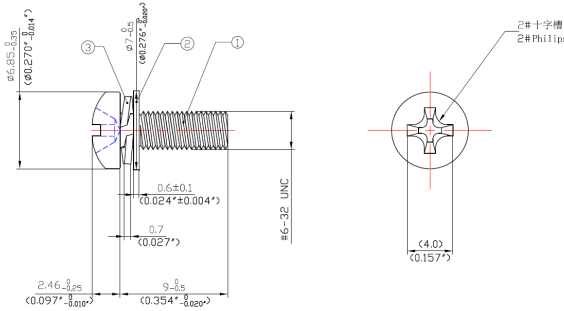

Fig.1. Preferred metal screws size

## Thermal Considerations

The power supply can be operated in a variety of thermal environments; however sufficient cooling should be provided to ensure reliable operation.

Considerations include ambient temperature, airflow, power supply dissipation and the need for increased reliability. A reduction in the operating temperature of the power supply will result in increased reliability. The thermal data presented here is based on measurements taken during testing in a wind tunnel or temperature chamber.

## Heat Transfer via Convection

Increased airflow through the power supply enhances the heat transfer via convection. Figure 2 shows the preferred airflow direction. Contact your ABB technical representative for derating information in other airflow directions.

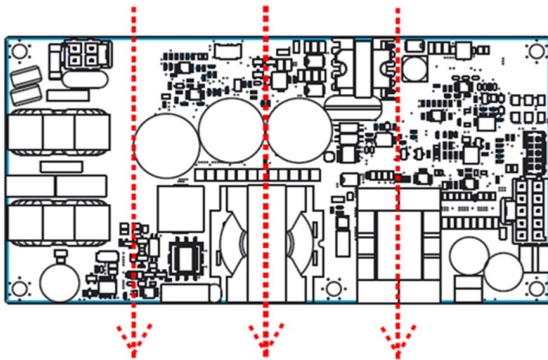

Fig. 2. Preferred airflow direction for cooling

## Operation in a Sealed Enclosure

The CLP0512DC power supply can also be operated in a sealed enclosure or in an environment where cooling is primarily via conduction. Figure 3 shows an arrangement where thermally conductive pads are used to transfer heat from the top and bottom of the power supply into the enclosure. The Max output power that can be delivered is provided in Table1 below.

Table 1. Output Power Capability via conduction cooling

Enclosure Outside Surface (°C)	Enclosure Inside Surface (°C)	Max. Output Power (W)
55	85C	420W

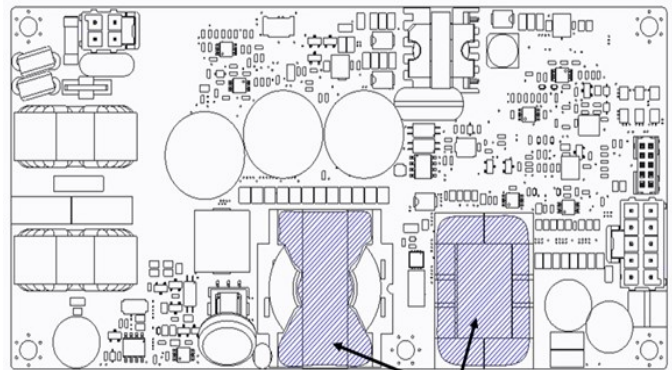

THERMALLY TIED TO TOP OF ENCLOSURE

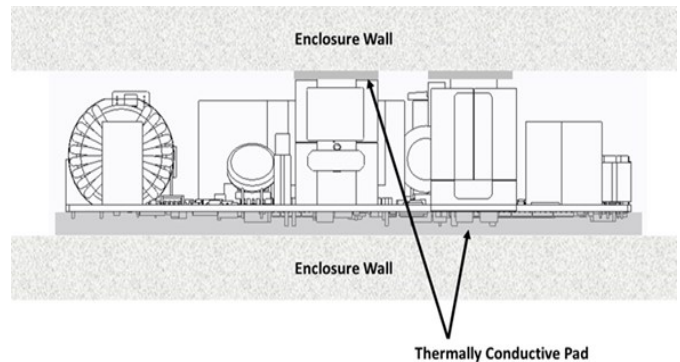

Fig. 3. Example of the CLP0512DC for sealed enclosure applications

Thermal conductivity should be 3.0 W/m-K for thermal pad application and 1kV+ isolation, example:

Thermal conductive (gap) pad:  
[http://www.bergquistcompany.com/pdfs/dataSheets/PDS\\_GP\\_HC3\\_0714%20v7.pdf](http://www.bergquistcompany.com/pdfs/dataSheets/PDS_GP_HC3_0714%20v7.pdf)

Thermal conductive (gap) pad:  
<https://www.lairdtech.com/products/tputty-502>



# Technical Specifications

## Derating with air flow

The output current rating with different ambient Temperature and airflow direction

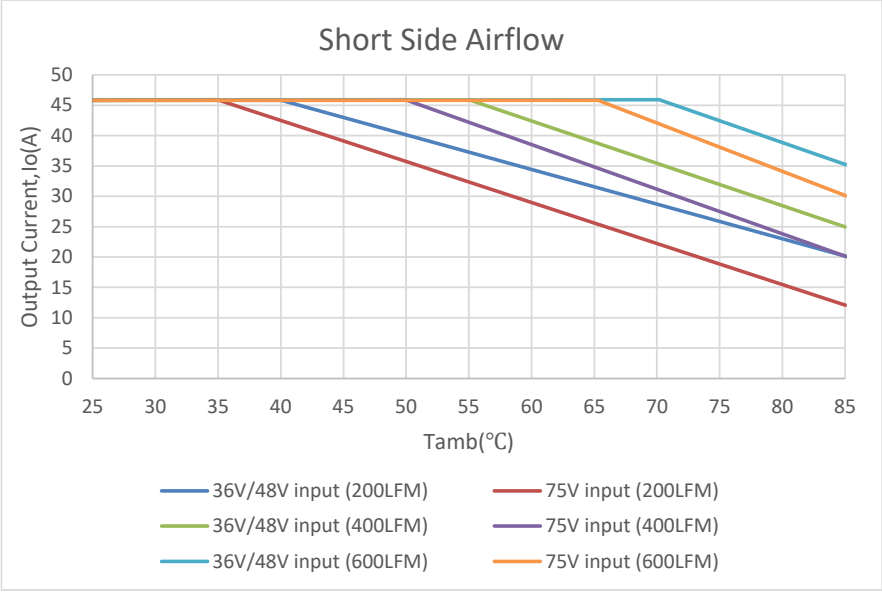
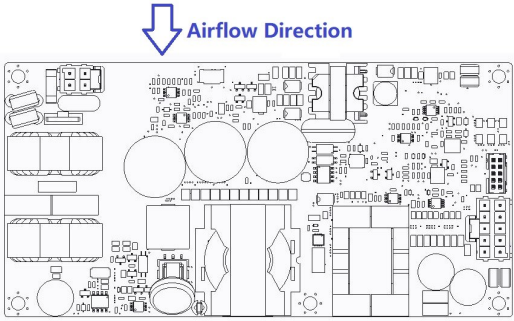

- Long Side Airflow:

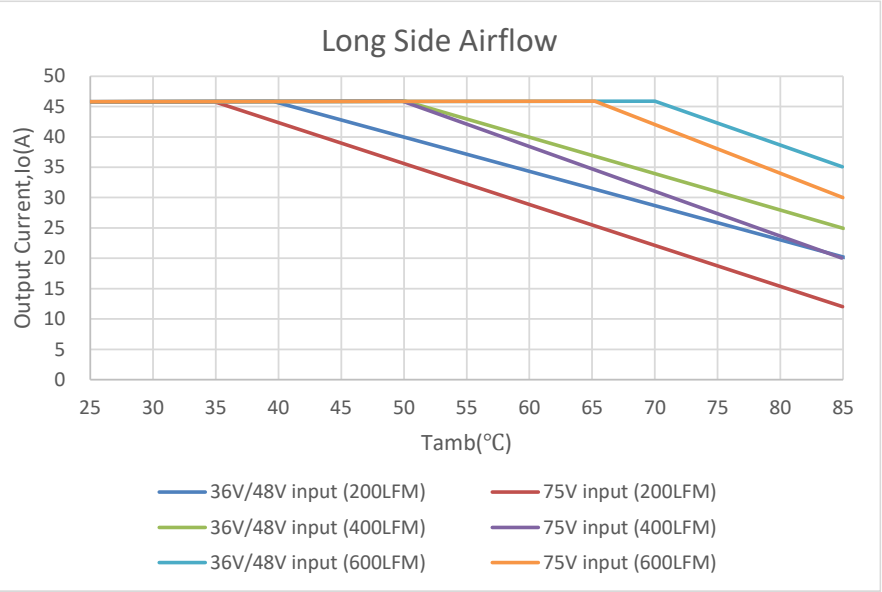
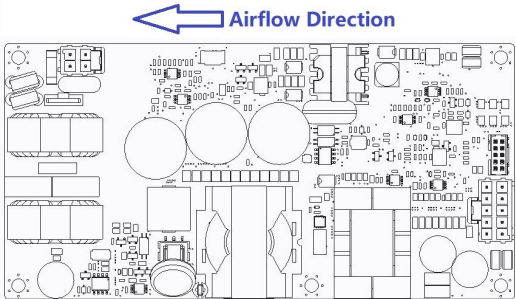

# Technical Specifications

## Mechanical Outline

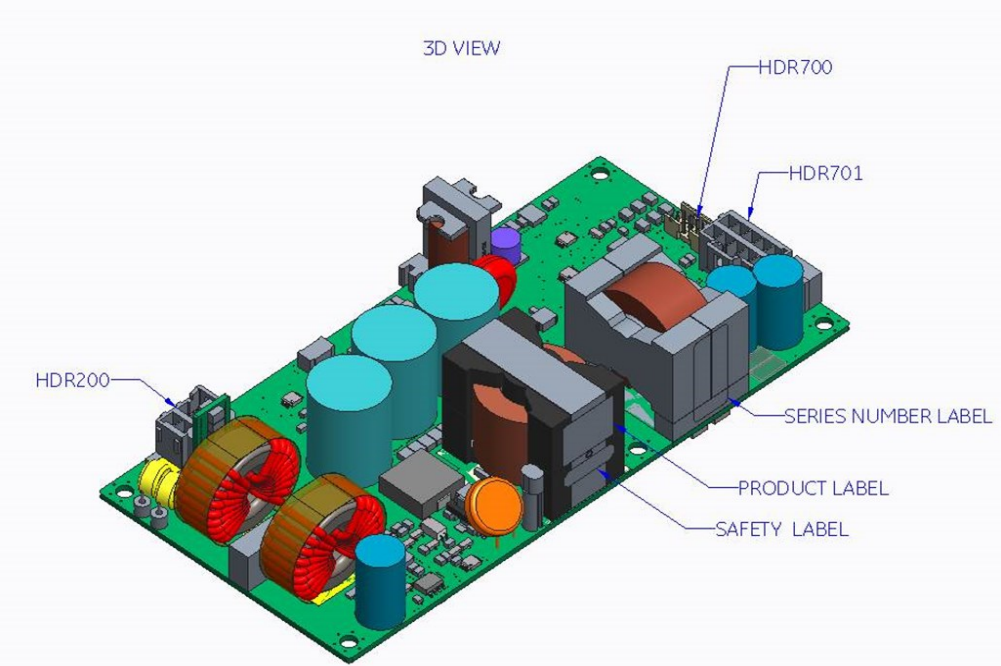
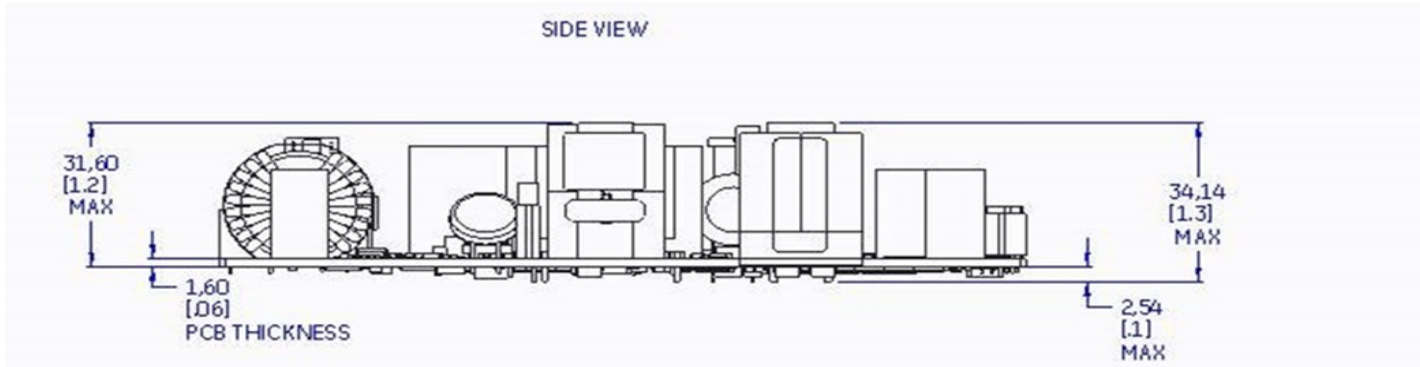
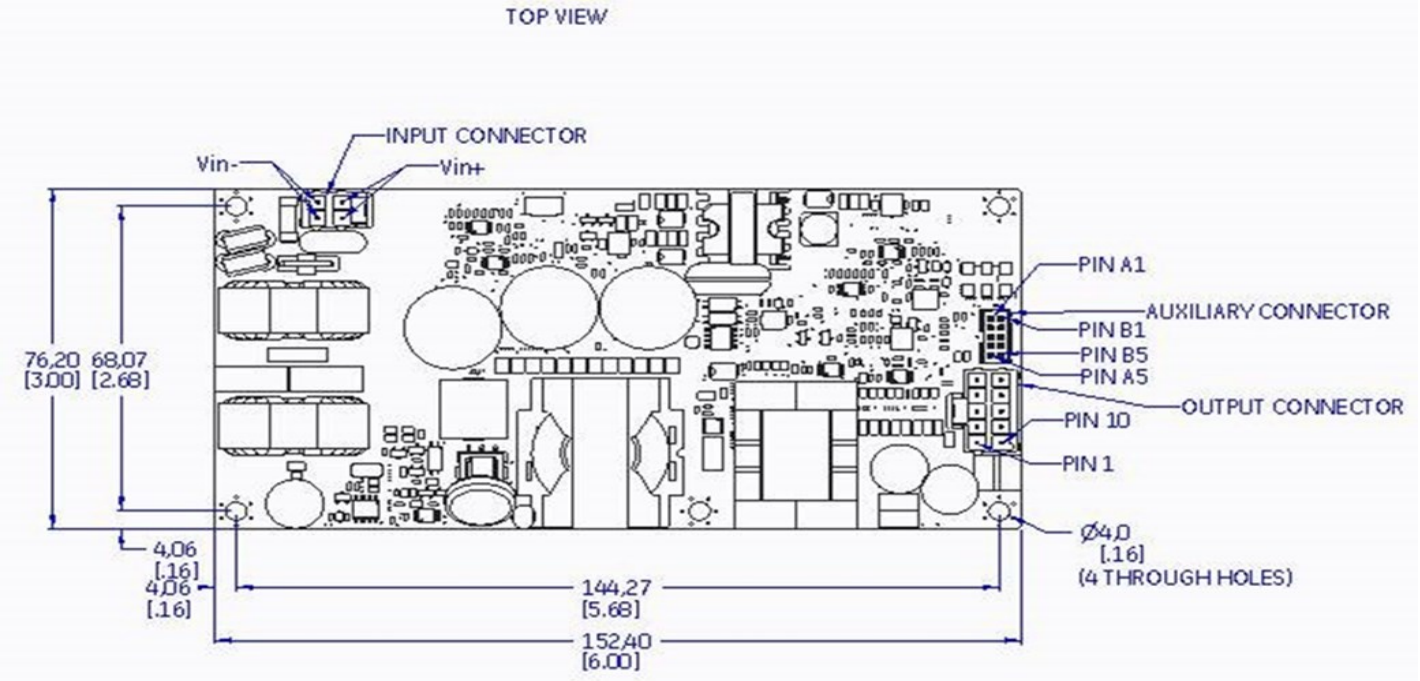

# Technical Specifications

## Connector Information

Connector	Connector on Power Supply	Mating Connector
DC Input Connector (HDR200)	Molex 172298-1204 or equivalent	Molex 172258-3104 or equivalent
DC Output Connector (HDR701)	Molex 172298-1110 or equivalent	Molex 172258-3110 or equivalent
Auxiliary Connector (HDR700)	FCI 98414-G04-10ULF or equivalent	FCI 90311-010LF or equivalent

## Pinout Information

DC Input Connector (HDR200)		DC Output Connector (HDR701)		Auxiliary Connector (HDR700)			
PIN 1,2	VIN+	PIN 1, 2, 3, 4, 5	VOUT +	PIN A1	5V Standby	PIN B1	PARALLEL
PIN 3,4	VIN-	PIN 6, 7, 8, 9, 10	VOUT – (Return)	PIN A2	5V Standby	PIN B2	5V Standby Return
				PIN A3	NC	PIN B3	5V Standby Return
				PIN A4	REMOTE SENSE +	PIN B4	DC_OK
				PIN A5	REMOTE SENSE –	PIN B5	ON/OFF



## Ordering Information

Please contact your ABB Sales Representative for pricing, availability and optional features.

Device Code	Input Voltage Range	Output Voltage	Output Current	On/Off Control	Standby Supply	Temperature Range	Comcode
CLP0512DCXXXZ01A (with conformal coating)	36 – 75Vdc	12.0Vdc	45.8A	Negative Logic	5V @ 1A	-40 to 85°C	CLP0512DCXXXZ01A

GE by ABB

601 Shiloh Rd.

Plano, TX USA

[Go.ABB/Industrial](#)

We reserve the right to make technical changes or modify the contents of this document without prior notice. With regard to purchase orders, the agreed particulars shall prevail. GE by ABB does not accept any responsibility whatsoever for potential errors or possible lack of information in this document.

We reserve all rights in this document and in the subject matter and illustrations contained therein. Any reproduction, disclosure to third parties or utilization of its contents – in whole or in parts – is forbidden without prior written consent of GE by ABB

Copyright© 2020 ABB  
All rights reserved