

## SUMMARY

### # Wires

Low voltage 16



*Image is for illustrative purpose only*

Series	2P
Termination type	Female solder
IP rating	50
AWG wire size	30.00 - 22.00
Cable Ø	3.20 - 9.20 mm
Status	active
Matching parts	<a href="#">CAB.M16.GLA.C52G</a>

### Download

[Request a quote](#)

[Catalog](#)

## TECHNICAL DETAILS

### Mechanics

Shell Style/Model	CK*: Fixed receptacle with two nuts (back panel mounting)
Keying	3 keys (alpha=0, gamma=60; Plug: male contacts; Receptacle: female contacts)
Housing Material	PSU (Polysulfone), gray
Weight	6.55 g

### Performance

Configuration	2P.M16 : 16 Low V.
Insulator	L: PEEK for solder contacts
Rated Current	6 Amps

### Specifications

Contact Type:	Solder
Contact Dia.:	0.7 mm (0.027in)
Bucket Dia.:	0.8 mm (0.031in)
Test voltage (kV rms) Contact-contact:	1.5
Air clearance min.:	0.47 mm
Creepage distance min.:	0.47 mm

### Others

LEMO products and services are provided "as is". LEMO makes no warranties or representations with regard to LEMO product & services or use of them, express, implied or statutory, including for accuracy, completeness, or security. The user is fully responsible for his products and applications using LEMO components.

Endurance (Shell): >1000 mating cycles  
 F ret (min): 150 N  
 F ret (max): 250 N  
 Steam sterilization: 20 times

## DRAWINGS

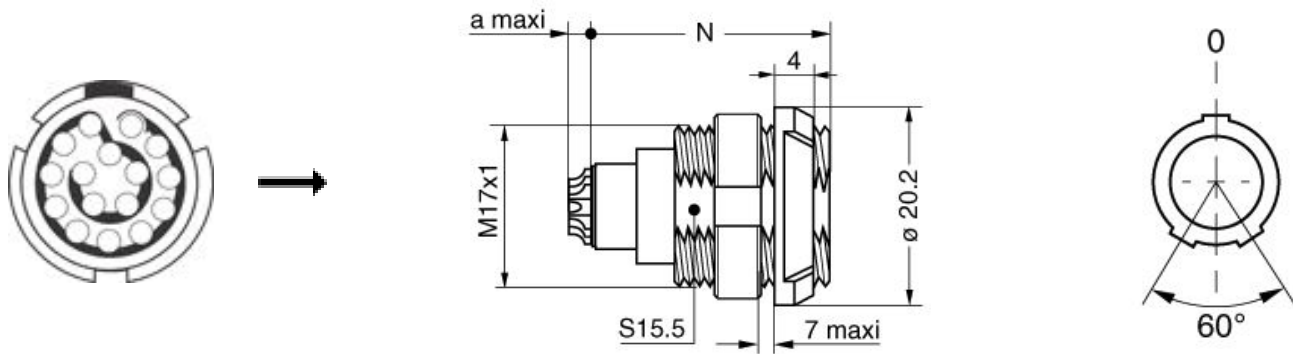

### Dimensions

	A	N	a
mm.	20.2	23.8	3.4-4.9
in.	0,80	0,94	0,13







## RECOMMENDED BY LEMO

### Tools

### Cables

CMN.16.B22.084PG3Z		Grey	
CMN.16.T22.076QGZE	TPR (medical)	Grey	
CMN.16.T28.059PGZE		Grey	
CMN.16.T28.059PNZE			

LEMO products and services are provided "as is". LEMO makes no warranties or representations with regard to LEMO product & services or use of them, express, implied or statutory, including for accuracy, completeness, or security. The user is fully responsible for his products and applications using LEMO components.

CMN.16.T28.070NNZZ			
CMN.16.T30.047QGZE	TPR (medical)	Grey	
116080	PUR	Black	
116280	PVC	Black	
16050	PVC	Black	
216220	PVC	Black	
216240	PVC	Black	
216260	PVC	Black	
316250	PVC	Grey	

LEMO products and services are provided "as is". LEMO makes no warranties or representations with regard to LEMO product & services or use of them, express, implied or statutory, including for accuracy, completeness, or security. The user is fully responsible for his products and applications using LEMO components.