

**Mounting Option**

104-.156 (3.96) Dia. Mounting Holes

**Contact Detail**

420-P.C. Tail .046x.015(1.17x0.38) - Tail LG.=.213(5.41)  
 .156 [3.96] Contact Spacing with Single Centreline Row

THIS IS A C.A.D. GENERATED DRAWING  
 DO NOT MAKE MANUAL REVISIONS TO MASTER.



ISSUE NUMBER

ORIGINAL ①

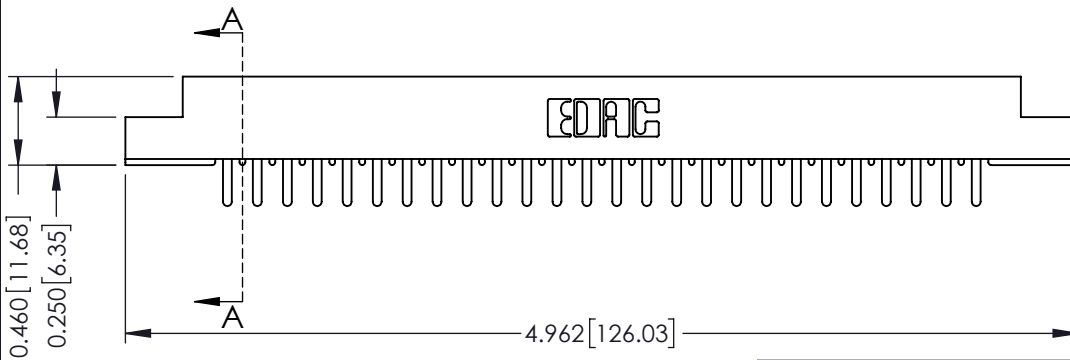
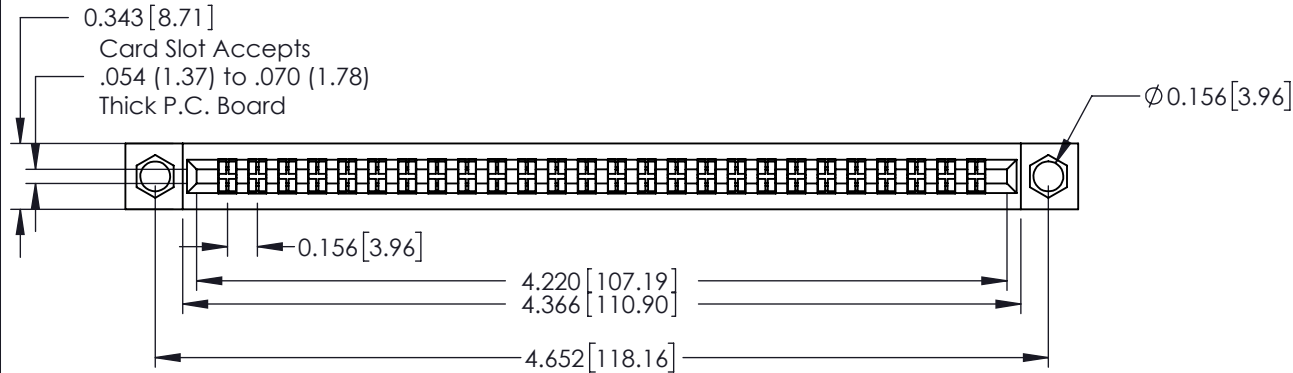

See Accompanying Pages for:  
 • Mounting Options

306 / 316 / 356 Card Edge Connector

Part Number: 306-026-420-104



EDAC INC  
 TORONTO, ONTARIO  
 CANADA

YOUR CONNECTION TO QUALITY & SERVICE

THESE DRAWINGS AND SPECIFICATIONS  
 ARE THE PROPERTY OF EDAC INC. AND  
 SHALL NOT BE REPRODUCED, OR COPIED  
 OR USED AS THE BASIS FOR THE  
 MANUFACTURE OR SALE OF APPARATUS  
 WITHOUT WRITTEN PERMISSION.

ACAD REFERENCE NO. 306 ENG MASTER

DRAWN: J.LEE DATE: SEPT. 14/09

CHECKED: DATE:

SCALE: NTS SHEET 1 OF 2

DRAWING NUMBER 306 Assembly ISSUE 1

THIS IS A C.A.D. GENERATED DRAWING  
DO NOT MAKE MANUAL REVISIONS TO MASTER.



ISSUE NUMBER

ORIGINAL ①

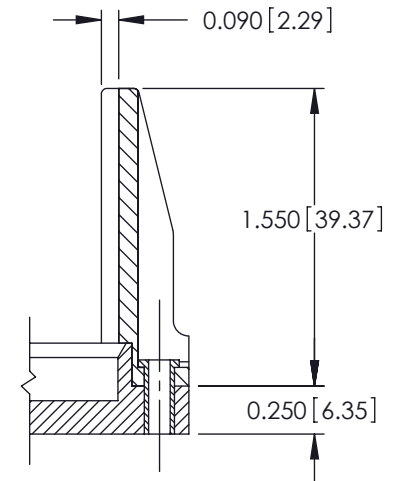

### 306 / 316 / 356 Card Edge Connector Mounting Options



YOUR CONNECTION TO QUALITY & SERVICE

EDAC INC  
TORONTO, ONTARIO  
CANADA

THESE DRAWINGS AND SPECIFICATIONS  
ARE THE PROPERTY OF EDAC INC. AND  
SHALL NOT BE REPRODUCED, OR COPIED  
OR USED AS THE BASIS FOR THE  
MANUFACTURE OR SALE OF APPARATUS  
WITHOUT WRITTEN PERMISSION.

ACAD REFERENCE NO. 306 ENG MASTER

DRAWN: J.LEE DATE: SEPT. 14/09

CHECKED: DATE:

SCALE: NTS SHEET 2 OF 2

DRAWING NUMBER ISSUE

306 Assembly

1