

XPOW-120AX-CV-U

SPECIFICATION SHEET AND MANUAL
2022

nicslab

Version: 1.0

Date: 4 July 2022

Important Notice and Disclaimer:

No part of this document may be reproduced in any form or by any means (including electronic storage and retrieval or translation into a foreign language) without prior agreement written consent from Nicslab. No responsibility is assumed by Nicslab for its use, nor for any infringements of patents or other rights of third parties that may result from its use. Trademarks and registered trademarks are the property of their respective owners.

This product is designated for skilled user. You are entirely responsible for (1) choosing the appropriate Nicslab products for your operation, (2) designing, validating and testing your operation, (3) ensuring your operation meets applicable standards, and any other safety, security or other requirements.

Copyright © 2022, Nicslab.

Safety Note

Do not operate this product in any manner not specified by Nicslab. Failure to comply with these precautions or with specific warnings or instructions elsewhere in this manual violates safety standards of design, manufacture, and intended use of the instrument. Nicslab assumes no responsibility for any damage caused by mishandling that is beyond normal usage defined in this manual of this product.

Before Applying DC Power Supply

Verify that DC power supply is good condition and safe to use. The input voltage is no more than 36 V or it can impair this product. Make all connections to the unit before applying power.

Do Not Discard the Instrument Cover

Only authorized personnel from Nicslab should remove the instrument cover.

Do Not Alter the Instrument

Do not put any unauthorized parts or modify the instrument without Nicslab approval and warranty.

Caution

This symbol indicates hazard of any operating procedure, practice, or the like that, if not correctly performed or adhered to, could result in damage to the product or loss of important data.

Contents

List of Tables	4
List of Figures	4
1. Introduction	5
2. Hardware	7
Specification Conditions	7
Hardware Requirement	7
Box Descriptions	8
XPOW-120AX-CV-U Specifications	11
Hardware Installation	12
3. Software and Graphical User Interface (GUI)	13
Software Requirement	13
Software Installation	13
How to Detect Which COM Is Used (<i>Windows only</i>)	14
Graphical User Interface (GUI)	14
Initializing the GUI	17
Constant Voltage (CV) Mode	18
Save and Upload	18
Sequence Automation	20
Record	21
Setting Voltage Limit	21
Setting Voltage Range	22
Setting Reading Speed	22
Value Increment Setting	23
4. Operating XPOW through SCPI command	24
Python Installation (Example)	24
Run Python Code (Example)	25
Python Function (Example)	26
SCPI Commands	29
5. Troubleshooting	32
6. Warranty	33
7. Contact	33

List of Tables

Table 1. Checklist Items	6
Table 2. Specification Conditions	7
Table 3. DAC Voltage Performance Specification	11
Table 5. Troubleshooting	32

List of Figures

Figure 1. XPOW-120AX-CV-U System Diagram	6
Figure 2. Product Dimension	8
Figure 3. Front, Back and Top View	9
Figure 4. GUI	15

1. Introduction

Nicslab XPOW-120AX-CV-U system is a versatile multichannel source measurement system. The XPOW-120AX-CV-U supports multiple voltage/current sourcing and voltage/current measurement. The system is suitable for sourcing and measuring low power applications from simple electronic circuits to complex photonic integrated circuits.

The XPOW-120AX-CV-U provides independent 120 channels controlled by GUI and SCPI through USB port. The system has Constant Voltage (CV) mode ranging from unipolar 0 – 5 Volt, 0 – 10 Volt, 0 – 20 Volt and 0 - 36 Volt. Each channels provides current for up to 300 mA.

The features for XPOW-120AX-CV-U in details are:

- 16-bits voltage control.
- Enable voltage range configuration through software (technology that enables the user to select the output range with software without lose control of the high-resolution feature).
- Intuitive GUI.
- Multi-connectors according to your application
- Maximum power output per channel 10 Watt.
- Real time voltage and current reading.
- Save function to create database.
- Upload function to generate the registrable voltage pattern.
- Sequence function for continuous voltage.
- Short circuits protection.
- SCPI command support (Python, C# and LabVIEW).
- SCPI Library (*Premium Upgrade*).
- Windows, Mac, and Linux support.
- USB port with USB line termination, filtering and ESD protection.
- Bi-directional EMI filtering prevents noise from entering/leaving the system.
- Compliance with IEC61000-4-2 ESD Protection for USB Port.

The XPOW-120AX-CV-U is connected with DC Power then you can plug into the Device-Under-Test (DUT) or multi-connector first. The voltage can be controlled through GUI or SCPI command via USB port.

The system diagram is as follow:

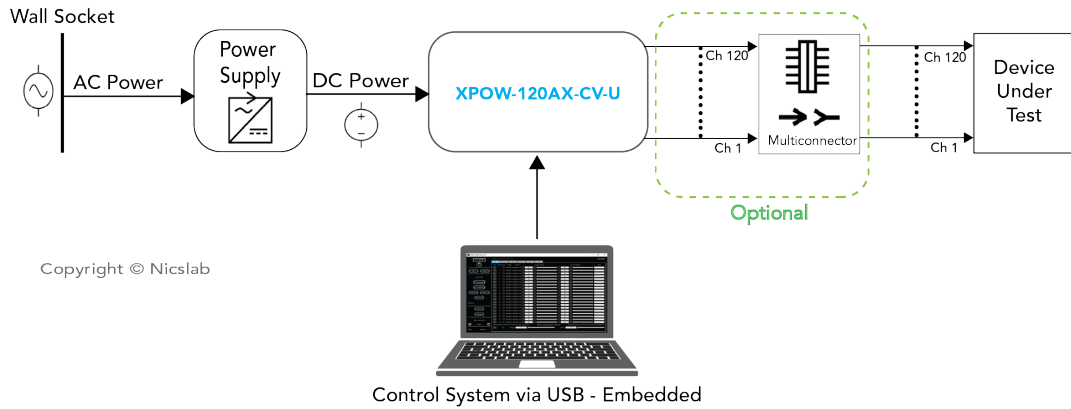

Figure 1. XPOW-120AX-CV-U System Diagram

The package should include the following items:

No	Item	Qty (pc)	Checklist
1	XPOW-120AX-CV-U Box	1	
2	DC power line cord	3	
3	Cable USB 3.0 type B	3	
4	Multi-connector 6	1	
5	USB hub	1	
6	Ribbon rainbow cable	6	
7	USB flash disk	1	
8	Inside USB flash disk: a. GUI b. Specification & Manual c. Test Report d. Serial key (Upgrade) e. XPOW key f. Software Library (Premium) g. Template Excel (upload, demo sequence)	1	

Table 1. Checklist Items

2. Hardware

Specification Conditions

The operating and measurement conditions are under the following conditions:

Items	Conditions
Room Temperature	0 ~ + 40°C
Humidity	5 ~ 80% (No Condensing)
Power Supply Input	DC Supply Max 36 V (potential at red & black DC in). Required headroom 1.4 – 2 V.
Waterproof/Dustproof	To be operated under room condition
Calibration period	2 years

Table 2. Specification Conditions

Hardware Requirement

The requirements for the PC/Laptop to be used for this product installation are:

- Resolution Min. 1024 x 768 pixel
- Hard disk Min. 500 MB of available free space (32-bit and 64-bit operating system)
- USB Port USB 2.0
- RAM Min. 2 GB
- CPU 2.4 GHz or faster

Box Descriptions

The box size is 232 (W) x 450 (L) x 102 (H) mm, as the pictures below:

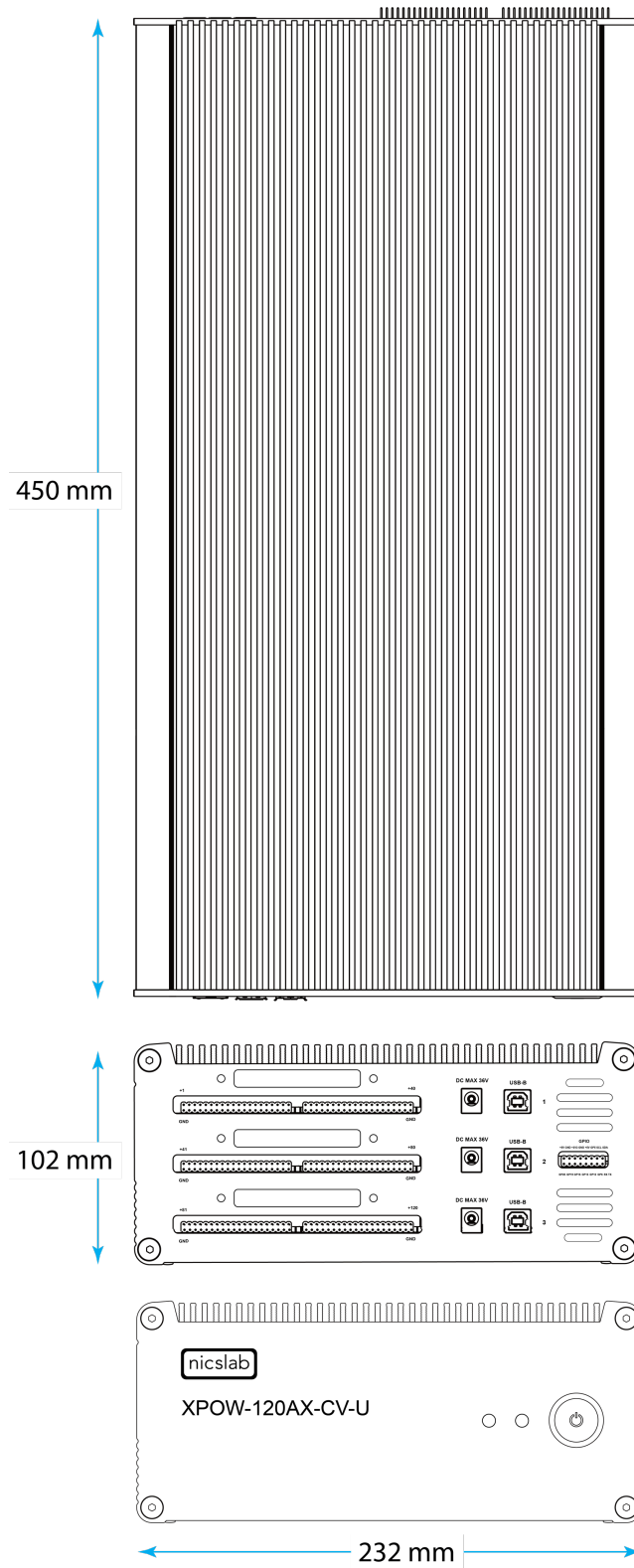

Figure 2. Product Dimension

The details of front and back panel of the box are described below:

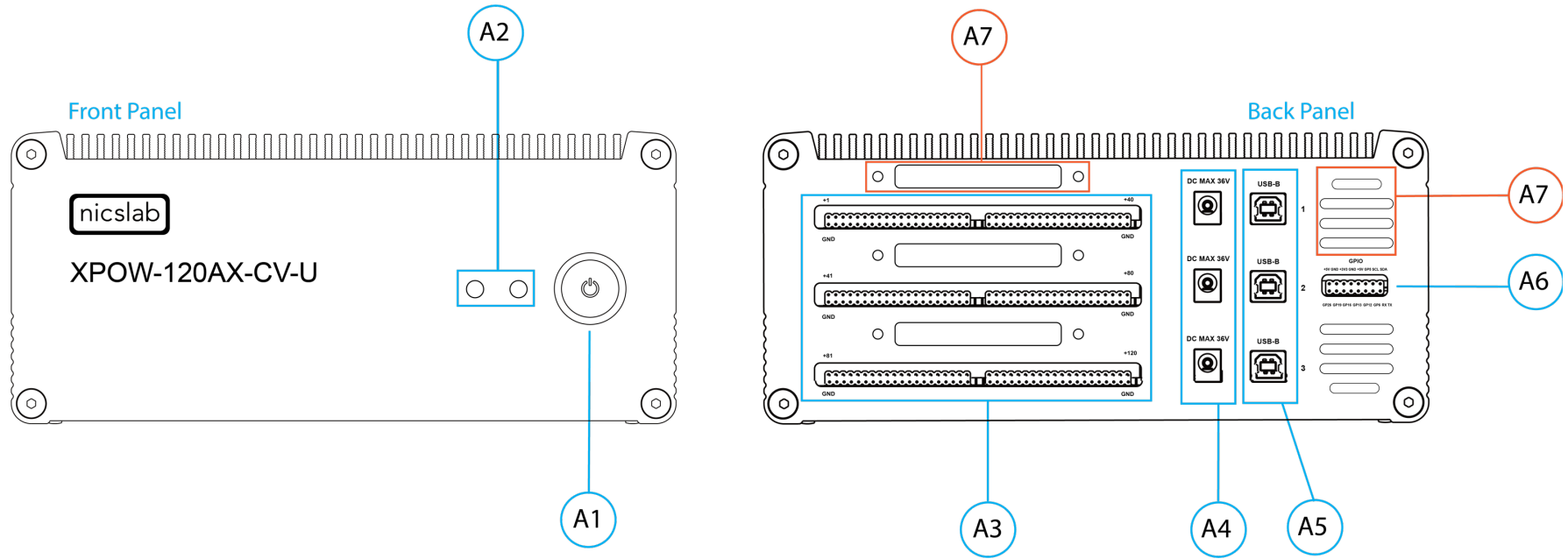

Figure 3. Front, Back and Top View

Note:

A1	Power Switch	Turns the instrument on or off.
A2	Indicator Light	Green -> Power Indicator. Blue -> Serial Transfer Data Active.
A3	Pin Output (40 channels per row)	To connect to Device Under Test (DUT) using cable or multi-connector. Row 1: Channel 1 to 40 Row 2: Channel 41 to 80 Row 3: Channel 81 to 120
A4	Input DC Max 36V	Caution Please follow the safety notice on your DC power supply. The DC input is no more than 36 V.
A5	USB-B	USB type B ports.
A6	GPIO	You may use for external control and monitoring direct to microprocessor.
A7	Airflow	For air circulation inside the box.

XPOW-120AX-CV-U Specifications

The performance specifications of Digital Analog Converter (DAC) voltage are listed in the table 3 below:

No	Parameter	Min	Typ	Max	Unit	Test conditions/comments
1	Resolution	16			Bits	
2	Integral nonlinearity (INL)	-1	± 0.5	1	LSB	All ranges, except 0 to 40 & ±2.5V
3	Differential Nonlinearity (DNL)	-1	± 0.5	1	LSB	Specified 16-bit monotonic
4	Total unadjusted error	-0.1	± 0.01	0.1	%FSR	All ranges except ±2.5V
5	Unipolar offset error	-0.03	± 0.015	0.03	%FSR	All unipolar ranges
6	Unipolar zero-code error	0	0.04	0.1	%FSR	All unipolar ranges
7	Full-scale error	-0.2	± 0.075	± 0.2	%FSR	All ranges
8	Gain error	-0.1	± 0.02	0.1	%FSR	All ranges except ±2.5V
9	Unipolar offset error drift		±2		ppm of FSR/°C	All unipolar ranges
10	Gain error drift		±2		ppm of FSR/°C	All ranges
11	Output voltage drift over time		5		Ppm of FSR	T _A = 40°C, Full-scale code, 1900 hours
DYNAMIC PERFORMANCE						
12	Output Voltage Settling Time		12		µs	¼ to ¾ and ¾ to ¼ scale setting time to ± 1 LSB, ±10V range, R _L = 5kΩ, C _L = 200pF
13	Slew Rate		4		V/µs	All range except 0 to 5V
14	Power-on glitch magnitude		0.3		V	Power-down to active DAC output, ±20V range, Midscale code, R _L = 5kΩ, C _L = 200pF
15	Output noise		15		µV p-p	0.1Hz to 10Hz, Midscale code, 0 to 5V range
16	Output noise density		78		nV/√Hz	1 kHz, Midscale code, 0 to 5V range
17	AC PSRR		1		LSB/V	Midscale code, frequency = 60Hz, amplitude 200 mVpp superimposed on V _{DD} , V _{CC} or V _{SS}
18	DC PSRR		1		LSB/V	Midscale code, V _{DD} = 5V, V _{CC} = 20V ±5%, V _{SS} = 20V
19	Code change glitch impulse		4		nV-s	1 LSB change around major carrier, 0 to 5V range
20	Channel to Channel AC crosstalk		4		nV-s	0 to 5V range. Measured channel at midscale. Full-scale swing on all other channels.
21	Channel to Channel DC crosstalk		0.25		LSB	0 to 5V range. Measured channel at midscale. All other channels at full-scale.
22	Digital feedthrough		1		nV-s	0 to 5V range, Midscale code, F _{SCLK} = 1MHz

Table 3. DAC Voltage Performance Specification

Hardware Installation

This section describes how to install XPOW-120AX-CV-U and how to connect your Device Under Test (DUT) to the output terminals.

The steps are as follow:

1. Precondition step: connect to the DC power supply (max 36 V). Make certain that DC power supply is always 'ON'.
2. Connect a USB cable to your workstation (PC/Laptop) via USB port.
3. Connect XPOW output to the multi-connector (optional, see the manual M1) and your Device Under Test (DUT).
4. After you install the software/GUI (see the [Software Installation](#) section), then the XPOW is ready to use by switching the ON/OFF button at the front panel.

3. Software and Graphical User Interface (GUI)

Software Requirement

The GUI software is suitable with the following operating systems:

- Windows® 7 (32-bit, 64-bit).
- Windows® 10 (32-bit, 64-bit).
- macOS Catalina.

Software Installation

The first step is to copy the GUI file into your hard disk. For Mac, both the GUI and Arduino must be copied inside the 'Application' folder.

Double click the icon below to install the GUI.

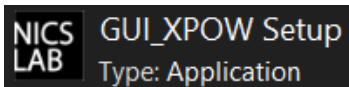

At the end step of the installation, check a 'Create a desktop shortcut'.

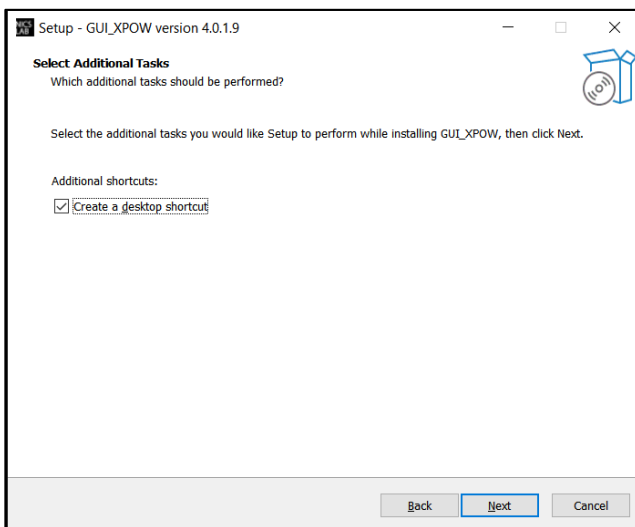

Double click the executable GUI icon (as below) on your desktop to launch the GUI.



How to Detect Which COM Is Used (*Windows only*)

1. Click **Start** . Type "Device Manager", and then click **Device Manager**.



2. Find **Ports (COM & LPT)**.

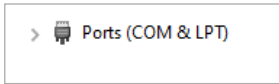

3. When XPOW connects on the computer, there are 3 (three) ports Arduino Leonardo detected with COM number as shown below.

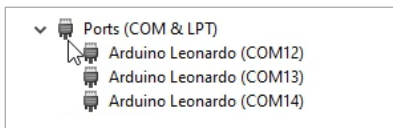

Graphical User Interface (GUI)

Start the XPOW by pressing the ON button, then you can control it by GUI, the display details are on the next page.

Note: You can also launch the GUI through language programming such as Python, C#, LabVIEW and Java.

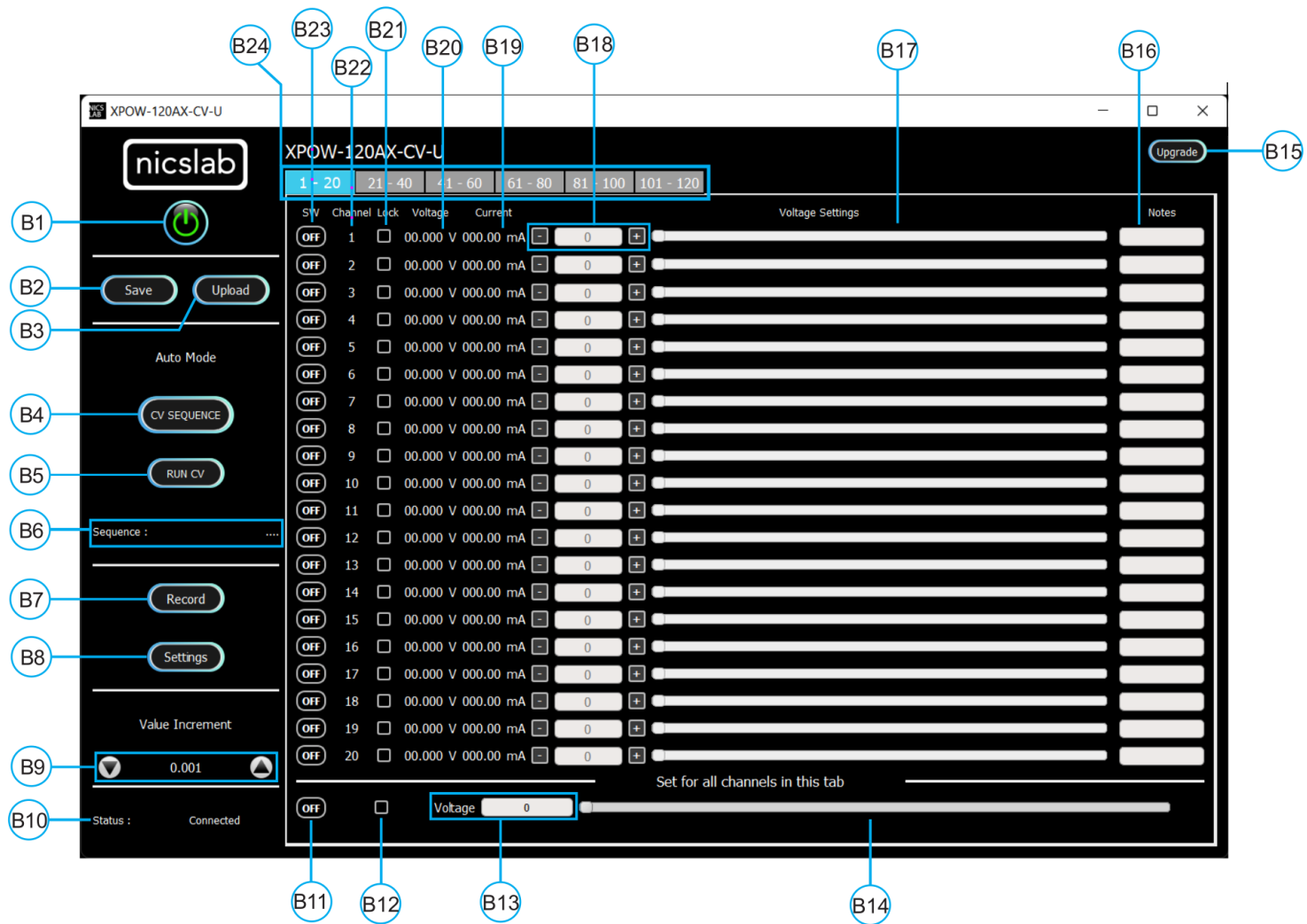

Figure 4. GUI

Note:

Callout	Description
B1	ON/OFF Switch
B2	Save File Button
B3	Upload File Button
B4	Auto Feature Sequence: Upload Table Button CV Mode
B5	Auto Feature: Run Button CV Mode
B6	Name of the Sequence
B7	Record Data Button
B8	Setting for: <ol style="list-style-type: none"> 1. Set Limit voltage values 2. V Range (16-bit precision for every range of voltages: 5, 10, 20, 36 V) 3. Set Reading speed of Voltage (Fast, Medium, Slow)
B9	Increment Settings
B10	Status of connection
B11	ON/OFF Button for the current Tab
B12	Enable/Disable (Lock) Channel Controller for all channels in current tab
B13	Text area to set the voltage for all channels in current tab
B14	Slider to set voltage for all channels in current tab
B15	Upgrade Button
B16	Notes
B17	Voltage Settings Slider
B18	Voltage Value Based on Increment Setting
B19	Current Value
B20	Voltage Value
B21	Enable/Disable (Lock) Channel Controller
B22	Number of channels
B23	ON/OFF Button per Channel
B24	Tab Channel

Initializing the GUI

This section shows how to initialize the GUI:

1. Launch the GUI by double clicking the executable GUI icon.
2. When you launch the GUI for the first time, input the 'XPOW Key' and put the correct 'COM' port.

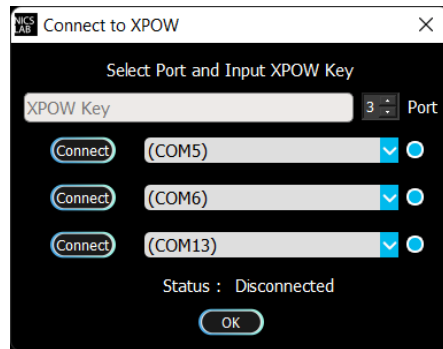

3. Press switch button (B1) on GUI to connect it with the XPOW.



4. Turn ON (B29) on each channel to input voltage values.

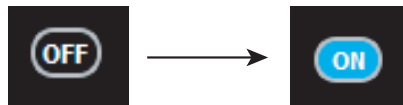

Constant Voltage (CV) Mode

This section shows how to do CV mode according to your aim:

To do CV mode, you need to adjust the voltage value on (B18) or slider (B17).

Important note: When you input manually the values, always press 'Enter'.

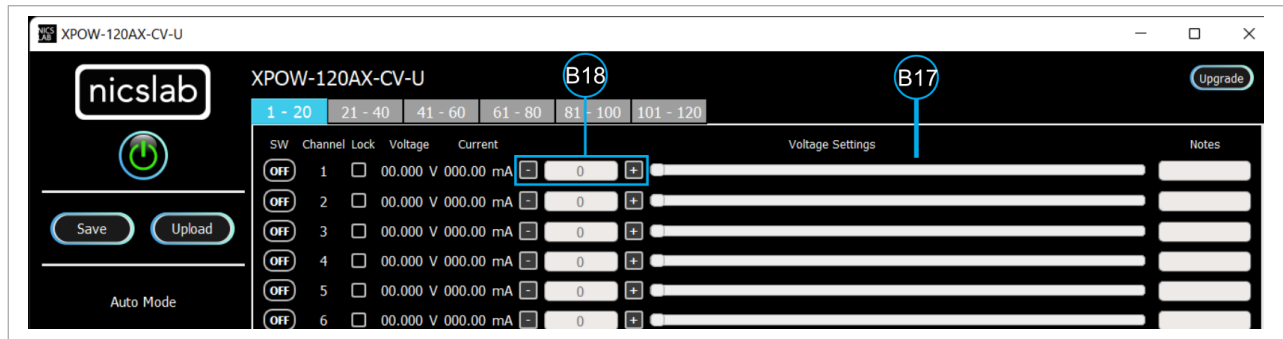

Save and Upload

The Excel file (.csv) resulted from the Save function can be uploaded again through the Upload button (B3). You may also create your own Excel file (.csv) of voltage and later be uploaded.

1. To save the configuration, click the 'Save' button (B2).

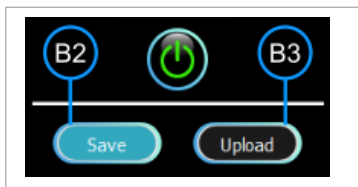

2. Select a directory and write the file name.

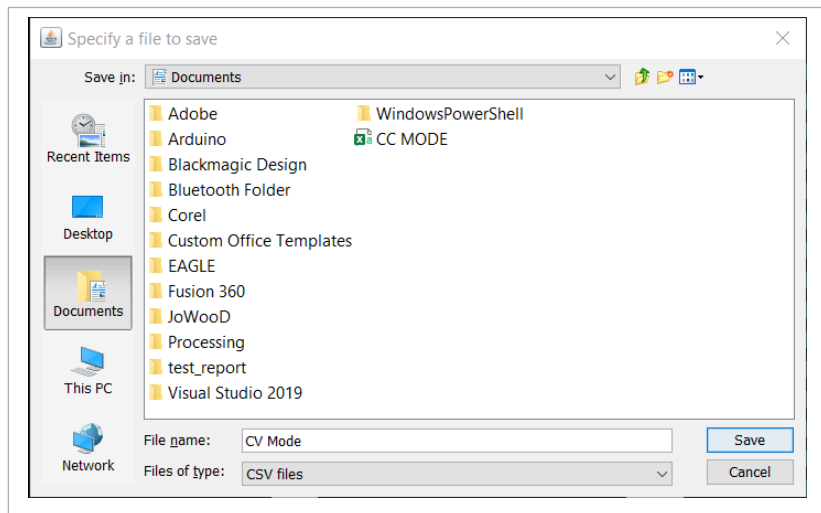

- The file will be automatically existing in the same file as XPOW 'GUI'. It is a .csv file.

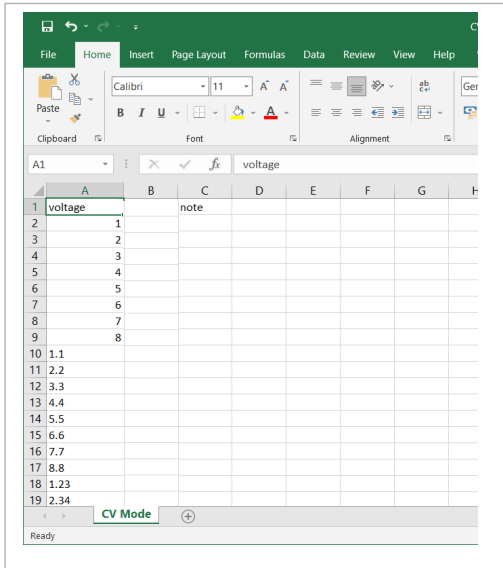

- To upload the configuration, click the 'Upload' button (B3).

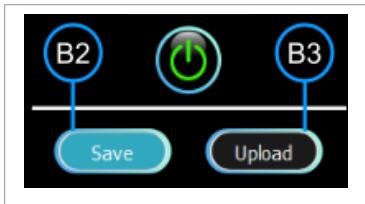

- Choose and open the intended file.

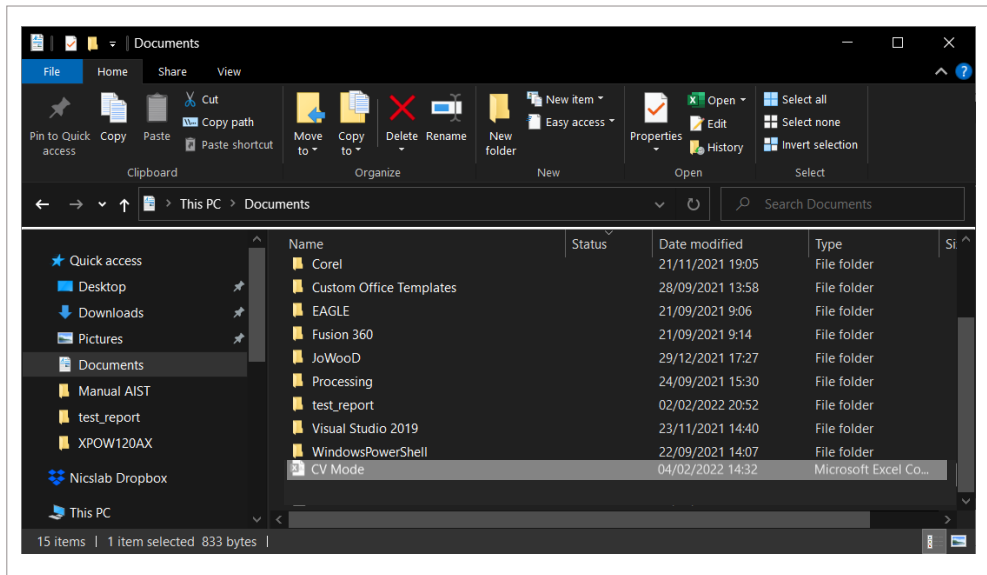

6. It will upload the configuration like the previous configuration.

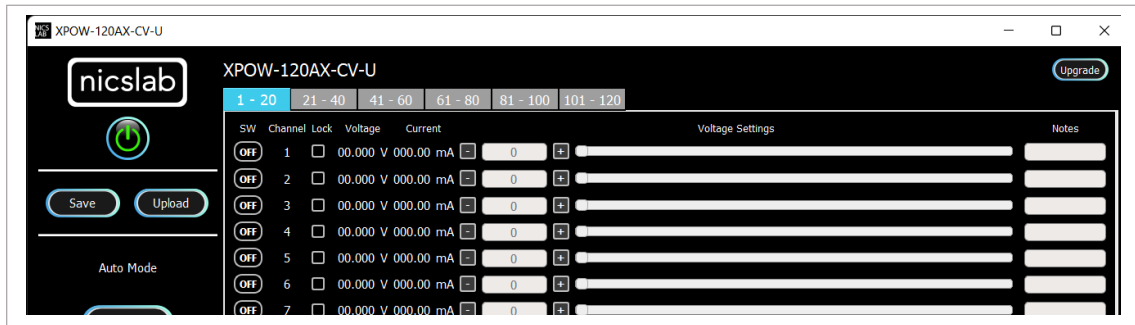

Sequence Automation

The sequence is the setting that automates the determined values of voltage (V) given the certain Delay Time (in millisecond).

1. The template of sequence is given, then you need to input your intended values of CV Sequence (from 0 to 36 V), and Delay Time (in millisecond). Set the delay time to more than 2 seconds to have more accurate values. To have a faster response (switching time) you can set via SCPI command).

	A	B	C	D	E	F	G	H	I	J
1		Seq 1	Seq 2	Seq 3	Seq 4	Seq 5	Seq 6	Seq 7	Seq 8	Note
2	Delay Time	6000	5478	4912	3409	4213	5902	6012		
3	Channel 1	5	50	0	100	150	150	0	300	Fan1
4	Channel 2	10	50	0	100	160	150	0	300	Fan2
5	Channel 3	15	50	0	100	170	150	0	300	Motor1
6	Channel 4	20	50	0	100	180	150	0	300	Motor2
7	Channel 5	25	50	0	100	190	150	0	300	Sensor1
8	Channel 6	30	50	0	100	200	150	0	300	Sensor2
9	Channel 7	35	50	0	100	210	150	0	300	Sensor3
10	Channel 8	40	50	0	100	220	150	0	300	Not Used

Note:

- A. Template given for CV sequences.
 - B. Input your intended values according to the modes (CV: 0 - 36V).
2. Choose CV Sequence mode (B4). When you click, say CV sequence you need to open the Excel sequence file (.csv).
 3. After uploading, choose sequence mode by clicking 'Run CV' (B5).

Record

'Record' (B7) keeps data of voltage values. The record starts by the time you click the Record button and finish until you click again the same button. The Excel file (.csv) will be created automatically in the same folder as XDAC's GUI file.

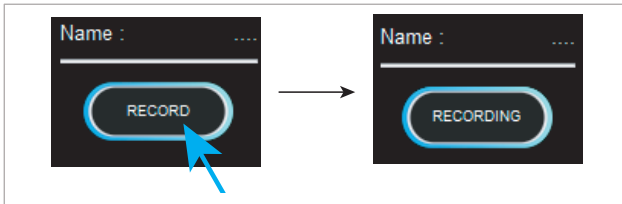

Setting Voltage Limit

Click the 'Settings' button (B8).

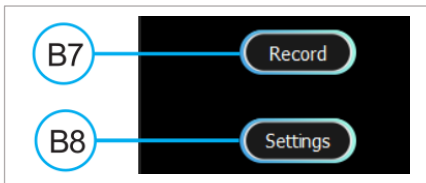

The 'Settings' feature consists of:

- set maximum limit for voltage values

The image shows two screenshots. The top screenshot is a dialog box titled 'Set Maximum Limit Settings for Each Channel' with tabs for 'Set Limit', 'Set Range', and 'Reading Speed'. The 'Set Limit' tab is active, showing a table of voltage limits for 20 channels. The bottom screenshot is the main GUI for 'XPOW-120AX-CV-U' showing a table of voltage settings for 6 channels.

Set Limit Voltage

Channel	Voltage	Current	Limit
1	0.806 V	006.43 mA	0.800
2	1.222 V	010.13 mA	1.200
3	2.519 V	019.90 mA	2.500
4	3.320 V	026.28 mA	3.300
5	4.556 V	037.17 mA	4.550
6	5.525 V	043.54 mA	5.500

Setting Voltage Range

Set range for voltage values where you can choose the voltage range to limit the voltage values (B17, B18, and B20), the range of voltages are 5 V, 10 V, 20 V and 36 V. Each range has 16-bit precision.

The image shows two screenshots from the Nicslab software. The top screenshot is a dialog box titled "Set Maximum Limit Settings For Each Channel" with three tabs: "Set Limit", "Set Range", and "Reading Speed". The "Set Range" tab is active, showing a grid of 20 channels. Each channel has four buttons for voltage ranges: 2.5, 5, 10, and 18. A blue arrow points from the "18" button for channel 17 to the main interface below. The bottom screenshot shows the main device interface for "XPOW-120AX-CV-U". It features a "nicslab" logo, a power button, "Save" and "Upload" buttons, and an "Auto Mode" indicator. A table displays channel settings:

SW	Channel	Lock	Voltage	Current	Voltage Settings	Notes
OFF	1	<input type="checkbox"/>	2.489	V 019.98 mA	2.500	
OFF	2	<input type="checkbox"/>	5.004	V 041.06 mA	5.000	
OFF	3	<input type="checkbox"/>	5.007	V 040.58 mA	5.000	
OFF	4	<input type="checkbox"/>	10.031	V 081.86 mA	10.000	
OFF	5	<input type="checkbox"/>	4.996	V 040.83 mA	5.000	
OFF	6	<input type="checkbox"/>	5.002	V 039.84 mA	5.000	

Setting Reading Speed

Set reading speed for voltage. There are three options which is Fast, Medium, and Slow. Faster options can make conversion time smaller but the results noisier.

The image shows a screenshot of the "Set Maximum Limit Settings For Each Channel" dialog box with the "Reading Speed" tab selected. The dialog is divided into two sections: "Reading Voltage" and "Reading Current". Each section has three buttons labeled "Fast", "Medium", and "Slow". A blue arrow points from the "Fast" button for "Reading Voltage" to the left.

Value Increment Setting

In this setting, the value of the voltage can be incrementally changed from minimum 0.001 to 1. Adjust the arrow to increase and decrease the value increment (B9).

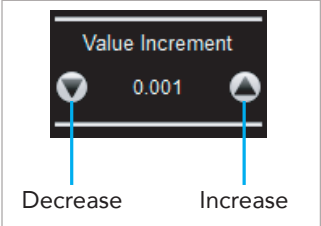

4. Operating XPOW through SCPI command

This section set guidelines to help you develop program for any language suits you best. The example language program is written in Python.

Python Installation (Example)

Please follow steps below for dynamic programming using SCPI command through Python via serial.

The following Python and packages need to be installed:

1. Python 2.7 or Python 3.X (download and install the latest version from www.python.org). *Tested with Python 3.7.
2. PyCharm 2017.3.4 or the latest version (download and install the latest version from <https://www.jetbrains.com/pycharm/>)

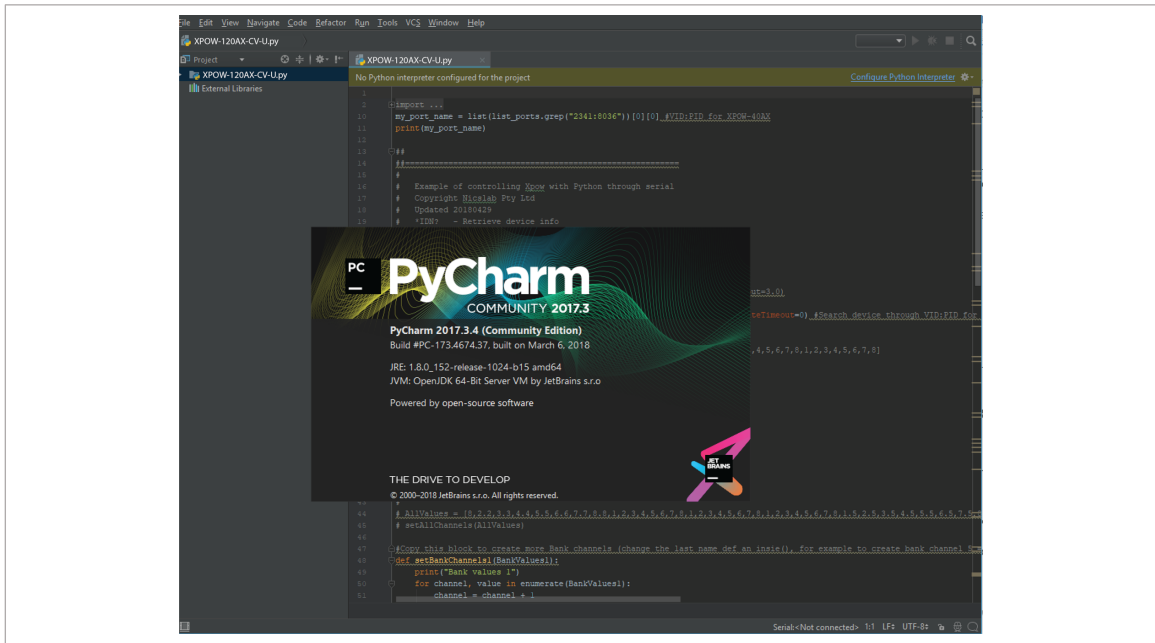

Run Python Code (Example)

To run the Python code please follow the steps below:

1. Open PyCharm software and open file example (e.g XPOW-120AX-CV-U.py)
2. Configure Python interpreter see figure below by clicking Configure Python Interpreter link on the top right-hand corner of the code, or in File >> Settings >> Project Interpreter in Windows or Preference >> Project Interpreter in Mac. Select Python 2.7 or Python 3.X in Project Interpreter list.

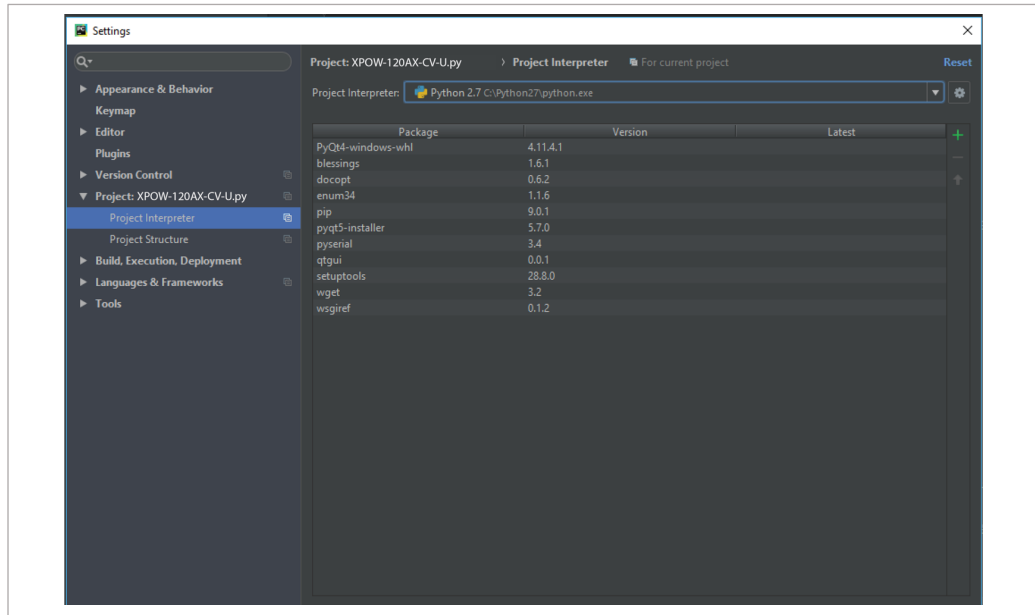

3. Install additional packages: enum34, pip, pyserial, setup tools by clicking + button, search and install all the packages.

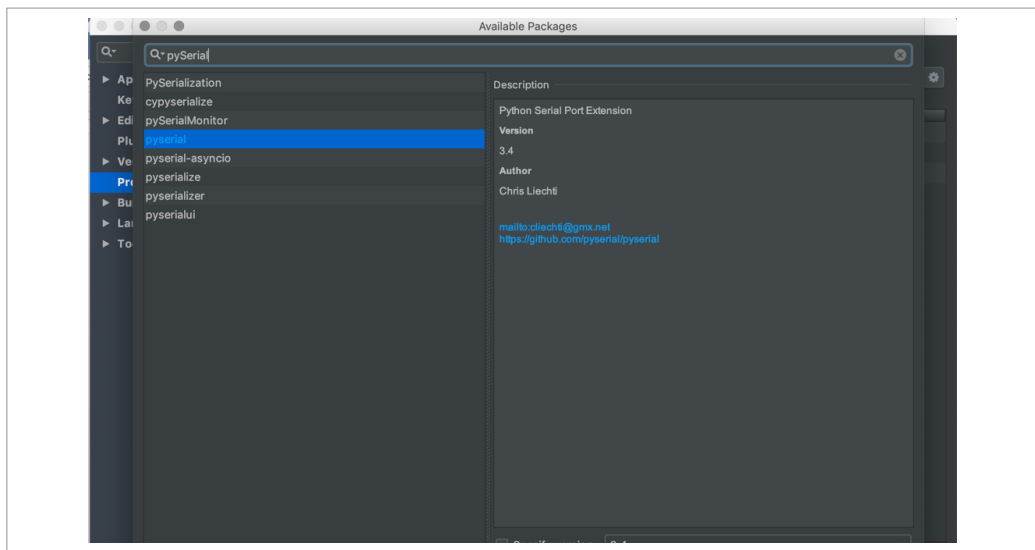

4. Select Python Configuration and choose the file name.
5. Run the file by clicking the green arrow button on the top right corner to test the XPOW (Please refer to the code and SCPI commands references).

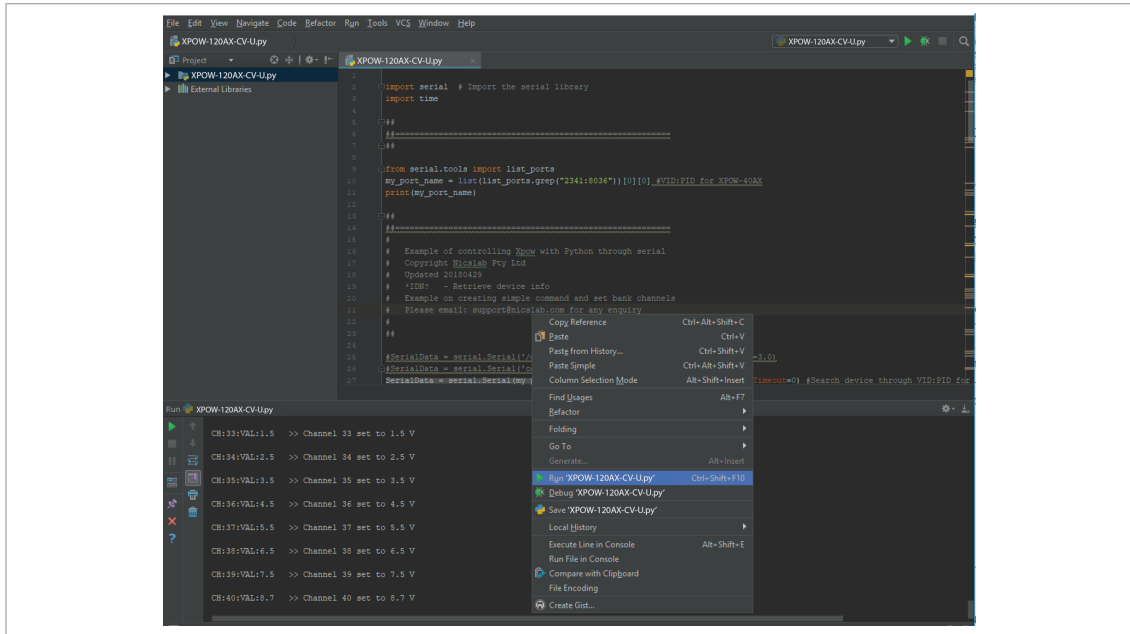

Python Function (Example)

1. Constant Voltage Calibration for single channel

Calibration work by applying voltage below the limit that we set in this function

```
cvCalibrationSingleChannel(channel, vcal)
```

channel (int): channel number

vcal (float): 0 - 36 V

Example:

Calibration with DUT connected to channel 1, voltage limit 0.5 V.

```
cvCalibrationSingleChannel(1, 0.5)
```

2. Constant Voltage Calibration for all channel

Calibration work by applying voltage below the limit that we set in this function

cvCalibrationAllChannel(vcal)

vcal (float array): 0 - 36 V

3. Set ON for single channel

setChannel(channel, voltageVal)

channel (int): channel number

voltageVal (float): 0 - 36 V

4. Set ON for all channels

setVoltage1Channels(AllVValues) for channels 1 - 40

setVoltage2Channels(AllVValues) for channels 41 - 80

setVoltage3Channels(AllVValues) for channels 81 - 120

AllVValues (float array): voltage values in array (V)

Example:

AllCValues = [100, 150, 100, 50, 200, 10, 10, 200] * 5

AllVValues = [20.1, 2.5, 13.0, 4, 5, 10.5, 9.5, 22] * 5

5. Set Range for all channels

setRange1Channels(AllRangeValues) for channels 1 - 40

setRange2Channels(AllRangeValues) for channels 41 - 80

setRange3Channels(AllRangeValues) for channels 81 - 120

AllRangeValues (Int array): voltage range index values in array

Array Index:

0: 0 - 5 V

1: 0 - 10 V

2: 0 - 20 V

4: 0 - 34 V (with 36 power supply)

Example:

AllRValues = [1, 0, 1, 0, 2, 1, 0, 2] * 5

6. Set GPIO digital output

setGPIO(index, value)

Index (int): Index of GP pin (12, 13, 16, 19, 26)

Value (string) : "HIGH" or "LOW"

Example:

Set GP26 output to digital high

```
setGPIO(26, "HIGH")
```

7. Set Measurement Config

for channels 1 - 40:

```
measurementConfig1(voltConvTime, currConvTime, averaging)
```

for channels 41 - 80:

```
measurementConfig2(voltConvTime, currConvTime, averaging)
```

for channels 81 - 120:

```
measurementConfig3(voltConvTime, currConvTime, averaging)
```

voltConvTime(Int uS): Voltage measurement conversion time

averaging(int): count of sample to be averaged

8. Set OFF for single channel

```
setOff(channel)
```

channel (int): channel number

9. Set OFF for all channels

```
setOffAllChannels(maxChannel)
```

maxChannel (int): maximum number of channels in XPOW

10. Read real-time value for single channel

```
readChannel(channel)
```

channel (int): channel number

11. Read real-time value for all channels

```
readCommand1(maxChannel) for channels 1 - 40
```

```
readCommand2(maxChannel) for channels 41 - 80
```

readCommand3(maxChannel) for channels 81 - 120
maxChannel (int): maximum number of channels in XPOW

12. Automatic Setting for One Channel

Change and record the value in one channel for every duration time. The result will be saved as CSV file.

sweepOne(channel, seqValueV, duration)

channel (int): channel number

seqValueV (float array): values for the voltage (V) for one channel in array.

duration (int): waiting time to change to next value in second

Example:

channel = 1

seqValueV = [20.1, 2.5, 13.0, 4, 5, 10.5, 9.5, 22]

seqValueC = [100, 150, 100, 50, 200, 10, 10]

duration = 5

SCPI Commands

The XPOW can be controlled using Standard Commands for Programmable Instruments (SCPI) with 115200 baud rates.

Description: Constant Voltage Mode Calibration for single channel

Format:

CH: [n]: CALIB:[BIT VALUES V]: [BIT VALUES C]

Description: Set output voltage for single channel

Format:

CH: [n]: VOLT:[BIT VALUES]

Example 1: Set output of channel to maximum or 65535 (16-bit max).

CH:1:VOLT:65535 (set output of channel 1 to max 36 V)

Example 2: Set output of channel 3 to half max or 32767

CH:3:VOLT:32767 (set output of channel 3 to 20 V)

Display real-time data for single channel

Format:

CH:[n]:VAL?

Description: Display voltage and current real-time value of channel n.

Example:

CH:1:VAL?

Result:

CH:1:VAL? >> Channel 1 = 6.101 V, 100.211 mA

Set output voltage for group of channels

Format:

CH:[m-n]:VOLT:[0-Vmax]

Description: Set output voltage of channel m to channel n to [0-65535].

Note: $1 \leq m < n \leq \text{Channel Max}$

Example:

CH:1-10:VOLT:32767 (set outputs of channel 1 to channel 10 to 20 Volt)

Set measurement config

Format:

MEAS:VoltConvTime:CurrConvTime:Averaging

Description: Set measurement conversion time in uS and averaging sample count.

Set pin GPIO

Output - High

Format:

GPIO:[PIN NAME]:HIGH

Description: Set GPIO pin 12 to high (5V)

Example:

GPIO:12:HIGH

Output - Low

Format:

GPIO:[PIN NAME]:LOW

Description: Set GPIO pin 16 to low (0V)

Example:

GPIO:16:LOW

Retrieve device information

Format:

*IDN?

Description: Get information of the device.

Example:

*IDN?

Result :

*IDN? >> XPOW-120AX-CV-U, Nicelab Ops, Inc.

Set range

Format:

CH: [n]: SVR:[0-3]

Note:

0 -> 5 V

1 -> 10 V

2 -> 20 V

3 -> 40 V

Default: 3

Example 1: Set range of channel to maximum.

CH:1:SVR:3 (set output of channel 1 to max 36 V)

Result:

<CH:1:SVR:3:OK>

5. Troubleshooting

Please use the following guidelines to identify particular problem. If the solution does not rectify the problem, contact us at support@nicslab.com.

Problem	Cause	Solution
Front end light off when switch turned on	No USB connection	Check USB connection to Laptop/PC
Blue light off when software active or software freeze	Initialization failed	Restart the software / unplug - plug USB connector/Press Reset Button
No channel output detected at device under test	Connection failed	Check metal pad check point to intended channel
No USB port detected at device manager	No USB connection	Turn on the XPOW-12AX box before running the application, and check USB connection Check the Arduino Driver if it is installed in the computer. Check to another USB port.
Unable to upload the file	File format problem	Make sure the file format is .csv
No value after upload the file	File problem	Check the file content: make sure there is no blank space on each row.
Unable to use Auto Mode feature	File format problem	Check file format: should be csv file. Check content format
Display value unstable in GUI	Serial Connection Failed	Change USB cable, use low noise USB cable

Table 4. Troubleshooting

6. Warranty

Nicslab warrants the hardware and software designed by Nicslab to work accordingly, fulfilling the highest standard of quality product. Nicslab is not liable for consequential or incidental damages or for errors in subject to misuse, neglect, accident, modification, use in critical operation, or has been soldered or altered in any way outside stated by us or unauthorized maintenance.

Nicslab retains to change the material and technical data of this manual at any time without notice, in future editions.

Please do not hesitate to contact us at support@nicslab.com if you would like to have more information on warranty or return and refund policy.

7. Contact

United States

Nicslab Inc

228 Hamilton Avenue, 3rd Floor, Palo Alto

Silicon Valley, CA, 94301

Phone number: +1 6507985000

Email: support@nicslab.com

Website: www.nicslab.com.

Indonesia

PT. Nicslab Global Industri

Wisma Monex 9th floor

Jl. Asia Afrika No. 133-132, Bandung West Java 40112

Phone: +62 22 8602 6854

WA: +62 813 2171 5791

Email: nicslab.id@nicslab.com

Book Meeting [here](#).