

SM20N561K501A

KPS SM SMD Indust COG HV, Ceramic, 560 pF, 10%, 500 VDC, COG, SMD, Fixed, High Volt, Low ESR, Leaded, Industrial, SM20

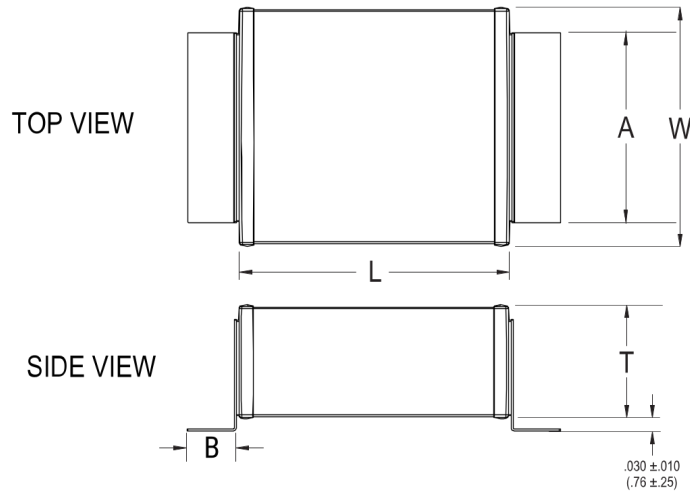

Click [here](#) for the 3D model.

Dimensions

Chip Size	SM20
L	3.81mm +/-0.381mm
W	3.81mm +/-0.381mm
T	3.302mm MAX
A	2.54mm MAX
B	2.54mm +/-0.508mm

Packaging Specifications

Packaging	Tray
Packaging Quantity	50

General Information

Series	KPS SM SMD Indust COG HV
Style	SMD Chip
Description	SMD, Fixed, High Volt, Low ESR, Leaded, Industrial
Features	High Voltage, Low ESR, Industrial Grade
RoHS	With Exemptions
REACH	SVHC (Pb - CAS 7439-92-1)
Termination	Silver
Marking	No
AEC-Q200	No
Shelf Life	78 Weeks
MSL	1

Specifications

Capacitance	560 pF
Capacitance Tolerance	10%
Voltage DC	500 VDC
Dielectric Withstanding Voltage	750 VDC
Temperature Range	-55/+125°C
Temperature Coefficient	COG
Dissipation Factor	0.15%
Insulation Resistance	100 GOhms

Statements of suitability for certain applications are based on our knowledge of typical operating conditions for such applications, but are not intended to constitute - and we specifically disclaim - any warranty concerning suitability for a specific customer application or use. This information is intended for use only by customers who have the requisite experience and capability to determine the correct products for their application. Any technical advice inferred from this information or otherwise provided by us with reference to the use of our products is given gratis, and we assume no obligation or liability for the advice given or results obtained.