

Printed-circuit board connector - FMC 1,5/ 3-STF-3,81 - 1748367

Please be informed that the data shown in this PDF Document is generated from our Online Catalog. Please find the complete data in the user's documentation. Our General Terms of Use for Downloads are valid (<http://phoenixcontact.com/download>)

PCB connector, nominal current: 8 A, number of positions: 3, pitch: 3.81 mm, connection method: Push-in spring connection, color: green, contact surface: Tin



The figure shows a 10-position version of the product

Your advantages

- ✓ Time saving push-in connection, tools not required
- ✓ Defined contact force ensures that contact remains stable over the long term
- ✓ Intuitive use through colour coded actuation lever
- ✓ Operation and conductor connection from one direction enable integration into front of device
- ✓ Screwable flange for superior mechanical stability

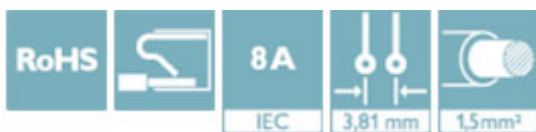

Key Commercial Data

Packing unit	50 pc
GTIN	 4 046356 311403
GTIN	4046356311403

Technical data

Dimensions

Length [l]	22.9 mm
Width [w]	21.52 mm
Height [h]	7.8 mm
Pitch	3.81 mm
Dimension a	7.62 mm

General

Range of articles	FMC 1,5/...-STF
Number of positions	3
Connection method	Push-in spring connection
Insulating material group	I

Printed-circuit board connector - FMC 1,5/ 3-STF-3,81 - 1748367

Technical data

General

Rated surge voltage (III/3)	2.5 kV
Rated surge voltage (III/2)	2.5 kV
Rated surge voltage (II/2)	2.5 kV
Rated voltage (III/3)	160 V
Rated voltage (III/2)	160 V
Rated voltage (II/2)	320 V
Connection in acc. with standard	EN-VDE
Nominal current I_N	8 A
Nominal cross section	1.5 mm ²
Maximum load current	8 A
Insulating material	PA
Flammability rating according to UL 94	V0
Internal cylindrical gage	A1
Stripping length	10 mm

Connection data

Conductor cross section solid min.	0.2 mm ²
Conductor cross section solid max.	1.5 mm ²
Conductor cross section flexible min.	0.2 mm ²
Conductor cross section flexible max.	1.5 mm ²
Conductor cross section flexible, with ferrule without plastic sleeve min.	0.25 mm ²
Conductor cross section flexible, with ferrule without plastic sleeve max.	1.5 mm ²
Conductor cross section flexible, with ferrule with plastic sleeve min.	0.25 mm ²
Conductor cross section flexible, with ferrule with plastic sleeve max.	0.75 mm ²
Conductor cross section AWG min.	24
Conductor cross section AWG max.	16
Minimum AWG according to UL/CUL	24
Maximum AWG according to UL/CUL	16

Specifications for ferrules

Recommended crimping pliers	1212034 CRIMPFOX 6
Ferrules without insulating collar, according to DIN 46228-1	Cross section: 0.25 mm ² ; Length: 7 mm
	Cross section: 0.34 mm ² ; Length: 7 mm
	Cross section: 0.5 mm ² ; Length: 8 mm ... 10 mm
	Cross section: 0.75 mm ² ; Length: 8 mm ... 10 mm
	Cross section: 1 mm ² ; Length: 8 mm ... 10 mm
	Cross section: 1.5 mm ² ; Length: 10 mm

Standards and Regulations

Connection in acc. with standard	EN-VDE
	CUL
Flammability rating according to UL 94	V0

Printed-circuit board connector - FMC 1,5/ 3-STF-3,81 - 1748367

Technical data

Environmental Product Compliance

China RoHS	Environmentally friendly use period: unlimited = EFUP-e
	No hazardous substances above threshold values

Drawings

Diagram

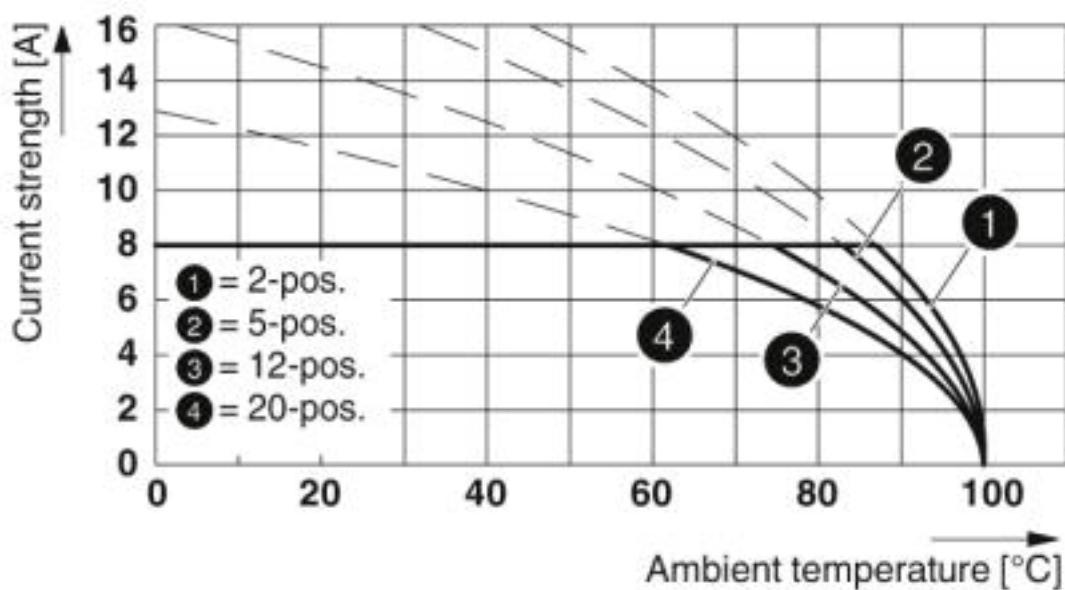

Type: FMC 1,5/...-STF-3,81 with MCV 1,5/...-GF-3,81 P... THR

Dimensional drawing

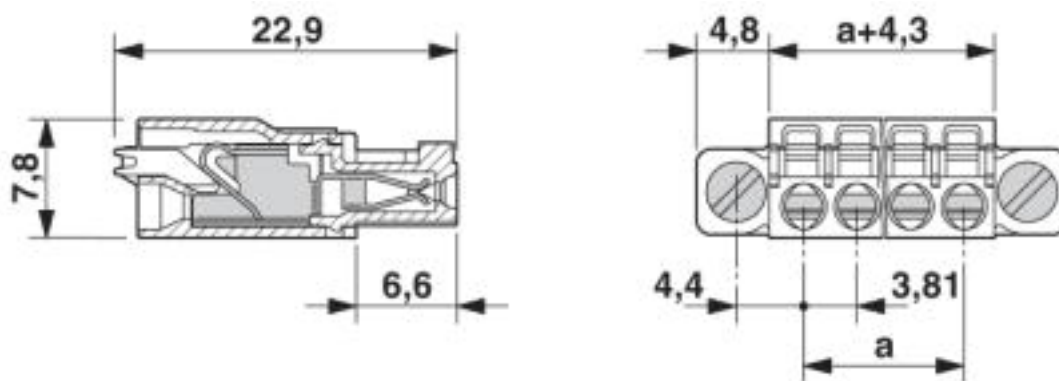

Approvals

Approvals

Printed-circuit board connector - FMC 1,5/ 3-STF-3,81 - 1748367

Approvals

Approvals

IECEE CB Scheme / VDE Gutachten mit Fertigungsüberwachung / EAC / cULus Recognized

Ex Approvals

Approval details

IECEE CB Scheme		http://www.iecee.org/	DE1-60987-B1B2
Nominal voltage UN	160 V		
Nominal current IN	8 A		
mm ² /AWG/kcmil	0.2-1.5		

VDE Gutachten mit Fertigungsüberwachung		http://www2.vde.com/de/Institut/Online-Service/VDE-gepruefteProdukte/Seiten/Online-Suche.aspx	40011723
Nominal voltage UN	160 V		
Nominal current IN	8 A		
mm ² /AWG/kcmil	0.2-1.5		

EAC		B.01742
-----	-------------------------------------------------------------------------------------	---------

cULus Recognized		http://database.ul.com/cgi-bin/XYV/template/LISEXT/1FRAME/index.htm	E60425-19920306
	B	C	
Nominal voltage UN	300 V	50 V	
Nominal current IN	8 A	8 A	
mm ² /AWG/kcmil	24-16	24-16	

Phoenix Contact 2019 © - all rights reserved
<http://www.phoenixcontact.com>

PHOENIX CONTACT GmbH & Co. KG
Flachmarktstr. 8
32825 Blomberg
Germany
Tel. +49 5235 300
Fax +49 5235 3 41200
<http://www.phoenixcontact.com>