

SUMMARY

Wires

Low voltage 4



Image is for illustrative purpose only

Series	SP
Termination type	Female solder
IP rating	50
AWG wire size	28.00 - 20.00
Cable Ø	0.00 - 0.00 mm
Status	active
Matching parts	SAN.M04.GLA.6A

Download

[Request a quote](#)

[Catalog](#)

TECHNICAL DETAILS

Mechanics

Shell Style/Model	SL_.SP*: Fixed socket, key (N) or keys (P, S and T), nut fixing, blue front nut
Keying	3 keys (alpha=0, gamma=30, plug: male contacts, receptacle: female contacts)
Housing Material	Proprietary sulfone, gray
Variant	A : Blue front nut
Weight	4.35 g

Performance

Configuration	SP.M04 : 4 Low V.
Insulator	L: PEEK (UL 94 / V-0/1.5)
Rated Current	11.5 Amps

Specifications

Contact Type: Solder
Contact Dia.: 1.3 mm (0.0512in)
Bucket Dia.: 1.1 mm (0.04in)
Min. Conductor: 0.36 mm² (AWG 22)
Max. Conductor: 1 mm² (AWG 18)
Test voltage (kV rms) Contact-contact: 1.60
Air clearance min.: 0.96 mm

LEMO products and services are provided "as is". LEMO makes no warranties or representations with regard to LEMO product & services or use of them, express, implied or statutory, including for accuracy, completeness, or security. The user is fully responsible for his products and applications using LEMO components.

Creepage distance min.: 0.96 mm

Others

Endurance (Shell): >2000 mating cycles

Temp (min / max): -50°C / +170°C

DRAWINGS

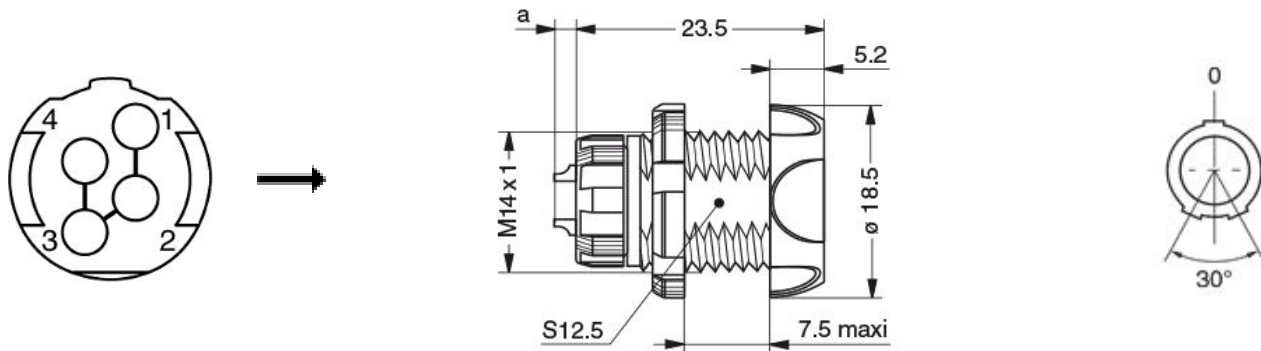

Dimensions

	B	N	a	e
mm.	18.5	23.5	2.2	M14x1
in.	0,73	0,93	0,09	

RECOMMENDED BY LEMO

Tools

LEMO products and services are provided "as is". LEMO makes no warranties or representations with regard to LEMO product & services or use of them, express, implied or statutory, including for accuracy, completeness, or security. The user is fully responsible for his products and applications using LEMO components.