

Silicon Carbide (SiC) MOSFET – EliteSiC, 33 mohm, 650 V, M2, Power88

NTMT045N065SC1

Features

- Typ. $R_{DS(on)} = 33\text{ m}\Omega$ @ $V_{GS} = 18\text{ V}$
Typ. $R_{DS(on)} = 45\text{ m}\Omega$ @ $V_{GS} = 15\text{ V}$
- Ultra Low Gate Charge ($Q_{G(tot)} = 105\text{ nC}$)
- Low Effective Output Capacitance ($C_{oss} = 162\text{ pF}$)
- 100% Avalanche Tested
- $T_J = 175^\circ\text{C}$
- RoHS Compliant

Typical Applications

- SMPS (Switching Mode Power Supplies)
- Solar Inverters
- UPS (Uninterruptable Power Supplies)
- Energy Storage

MAXIMUM RATINGS ($T_J = 25^\circ\text{C}$ unless otherwise noted)

Parameter		Symbol	Value	Unit	
Drain-to-Source Voltage		V_{DSS}	650	V	
Gate-to-Source Voltage		V_{GS}	-8/+22	V	
Recommended Operation Values of Gate – Source Voltage		$T_C < 175^\circ\text{C}$ V_{GSop}	-5/+18	V	
Continuous Drain Current (Note 2)	Steady State	$T_C = 25^\circ\text{C}$	I_D	55	A
			P_D	187	W
Continuous Drain Current (Notes 1, 2)	Steady State	$T_C = 100^\circ\text{C}$	I_D	39	A
			P_D	94	W
Pulsed Drain Current (Note 3)		$T_C = 25^\circ\text{C}$	I_{DM}	197	A
Operating Junction and Storage Temperature Range		T_J, T_{stg}	-55 to +175	$^\circ\text{C}$	
Source Current (Body Diode)		I_S	45	A	
Single Pulse Drain-to-Source Avalanche Energy ($I_L = 12\text{ A}_{pk}$, $L = 1\text{ mH}$) (Note 4)		E_{AS}	72	mJ	
Maximum Lead Temperature for Soldering, 1/8" from Case for 10 Seconds		T_L	260	$^\circ\text{C}$	

Stresses exceeding those listed in the Maximum Ratings table may damage the device. If any of these limits are exceeded, device functionality should not be assumed, damage may occur and reliability may be affected.

1. Surface mounted on a FR-4 board using 1 in2 pad of 2 oz copper.
2. The entire application environment impacts the thermal resistance values shown, they are not constants and are only valid for the particular conditions noted.
3. Repetitive rating, limited by max junction temperature.
4. E_{AS} of 72 mJ is based on starting $T_J = 25^\circ\text{C}$; $L = 1\text{ mH}$, $I_{AS} = 12\text{ A}$, $V_{DD} = 50\text{ V}$, $V_{GS} = 18\text{ V}$.

V_{DSS}	$R_{DS(on)}\text{ MAX}$	$I_D\text{ MAX}$
650 V	50 m Ω @ 18 V	55 A

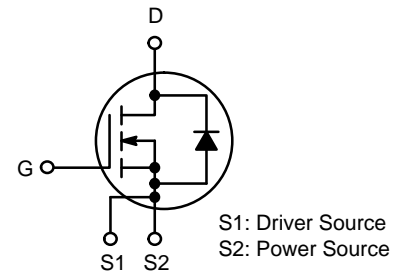

POWER MOSFET

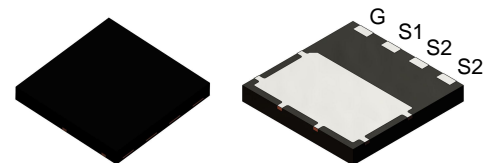

TDFN4 8x8 2P
CASE 520AB

MARKING DIAGRAM

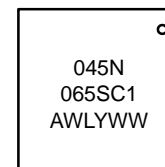

- 045N065SC1 = Specific Device Code
A = Assembly Location
WL = Wafer Lot
Y = Year
WW = Work Week

ORDERING INFORMATION

Device	Package	Shipping†
NTMT045N065SC1	TDFN4 (Pb-Free)	3000 / Tape & Reel

†For information on tape and reel specifications, including part orientation and tape sizes, please refer to our Tape and Reel Packaging Specification Brochure, BRD8011/D.

NTMT045N065SC1

THERMAL CHARACTERISTICS

Parameter	Symbol	Max	Unit
Junction-to-Case – Steady State (Note 2)	$R_{\theta JC}$	0.80	°C/W
Junction-to-Ambient – Steady State (Notes 1, 2)	$R_{\theta JA}$	45	°C/W

ELECTRICAL CHARACTERISTICS ($T_J = 25^\circ\text{C}$ unless otherwise stated)

Parameter	Symbol	Test Condition	Min	Typ	Max	Unit
-----------	--------	----------------	-----	-----	-----	------

OFF CHARACTERISTICS

Drain-to-Source Breakdown Voltage	$V_{(BR)DSS}$	$V_{GS} = 0\text{ V}, I_D = 1\text{ mA}$	650	–	–	V	
Drain-to-Source Breakdown Voltage Temperature Coefficient	$V_{(BR)DSS}/T_J$	$I_D = 20\text{ mA}$, refer to 25°C	–	0.15	–	V/°C	
Zero Gate Voltage Drain Current	I_{DSS}	$V_{GS} = 0\text{ V}, V_{DS} = 650\text{ V}$	$T_J = 25^\circ\text{C}$	–	–	10	μA
			$T_J = 175^\circ\text{C}$	–	–	1	mA
Gate-to-Source Leakage Current	I_{GSS}	$V_{GS} = +18/-5\text{ V}, V_{DS} = 0\text{ V}$	–	–	250	nA	

ON CHARACTERISTICS

Gate Threshold Voltage	$V_{GS(TH)}$	$V_{GS} = V_{DS}, I_D = 8\text{ mA}$	1.8	2.8	4.3	V
Recommended Gate Voltage	V_{GOP}		–5	–	+18	V
Drain-to-Source On Resistance	$R_{DS(on)}$	$V_{GS} = 15\text{ V}, I_D = 25\text{ A}, T_J = 25^\circ\text{C}$	–	45	–	m Ω
		$V_{GS} = 18\text{ V}, I_D = 25\text{ A}, T_J = 25^\circ\text{C}$	–	33	50	
		$V_{GS} = 18\text{ V}, I_D = 25\text{ A}, T_J = 175^\circ\text{C}$	–	40	–	
Forward Transconductance	g_{FS}	$V_{DS} = 10\text{ V}, I_D = 25\text{ A}$	–	16	–	S

CHARGES, CAPACITANCES & GATE RESISTANCE

Input Capacitance	C_{ISS}	$V_{GS} = 0\text{ V}, f = 1\text{ MHz}, V_{DS} = 325\text{ V}$	–	1870	–	pF
Output Capacitance	C_{OSS}		–	162	–	
Reverse Transfer Capacitance	C_{RSS}		–	14	–	
Total Gate Charge	$Q_{G(TOT)}$	$V_{GS} = -5/18\text{ V}, V_{DS} = 520\text{ V}, I_D = 25\text{ A}$	–	105	–	nC
Gate-to-Source Charge	Q_{GS}		–	27	–	
Gate-to-Drain Charge	Q_{GD}		–	30	–	
Gate-Resistance	R_G	$f = 1\text{ MHz}$	–	3.1	–	Ω

SWITCHING CHARACTERISTICS

Turn-On Delay Time	$t_{d(ON)}$	$V_{GS} = -5/18\text{ V}, V_{DS} = 400\text{ V}, I_D = 25\text{ A}, R_G = 2.2\ \Omega,$ Inductive Load	–	13	–	ns
Rise Time	t_r		–	14	–	
Turn-Off Delay Time	$t_{d(OFF)}$		–	26	–	
Fall Time	t_f		–	7	–	
Turn-On Switching Loss	E_{ON}		–	47	–	μJ
Turn-Off Switching Loss	E_{OFF}		–	33	–	
Total Switching Loss	E_{TOT}		–	80	–	

SOURCE-DRAIN DIODE CHARACTERISTICS

Continuous Source-Drain Diode Forward Current	I_{SD}	$V_{GS} = -5\text{ V}, T_J = 25^\circ\text{C}$	–	–	45	A
Pulsed Source-Drain Diode Forward Current (Note 3)	I_{SDM}	$V_{GS} = -5\text{ V}, T_J = 25^\circ\text{C}$	–	–	197	A
Forward Diode Voltage	V_{SD}	$V_{GS} = -5\text{ V}, I_{SD} = 25\text{ A}, T_J = 25^\circ\text{C}$	–	4.4	–	V

NTMT045N065SC1

ELECTRICAL CHARACTERISTICS ($T_J = 25^\circ\text{C}$ unless otherwise stated) (continued)

Parameter	Symbol	Test Condition	Min	Typ	Max	Unit
SOURCE-DRAIN DIODE CHARACTERISTICS						
Reverse Recovery Time	t_{RR}	$V_{GS} = -5/18\text{ V}$, $I_{SD} = 25\text{ A}$, $di_S/dt = 1000\text{ A}/\mu\text{s}$	-	20	-	ns
Reverse Recovery Charge	Q_{RR}		-	108	-	nC
Reverse Recovery Energy	E_{REC}		-	4.5	-	μJ
Peak Reverse Recovery Current	I_{RRM}		-	11	-	A
Charge time	T_a		-	11	-	ns
Discharge time	T_b		-	8.5	-	ns

Product parametric performance is indicated in the Electrical Characteristics for the listed test conditions, unless otherwise noted. Product performance may not be indicated by the Electrical Characteristics if operated under different conditions.

TYPICAL CHARACTERISTICS

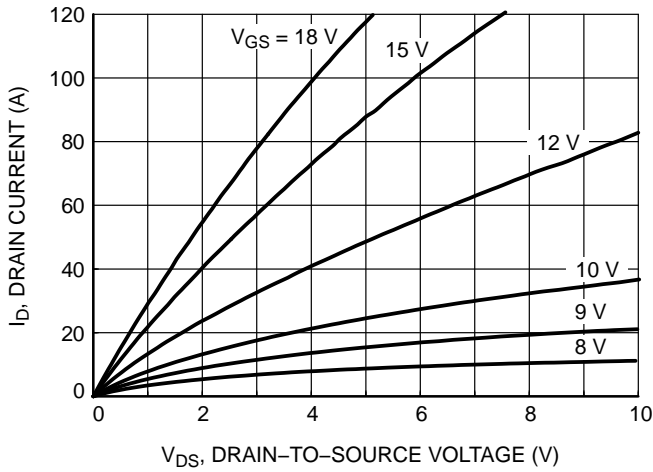

Figure 1. On-Region Characteristics

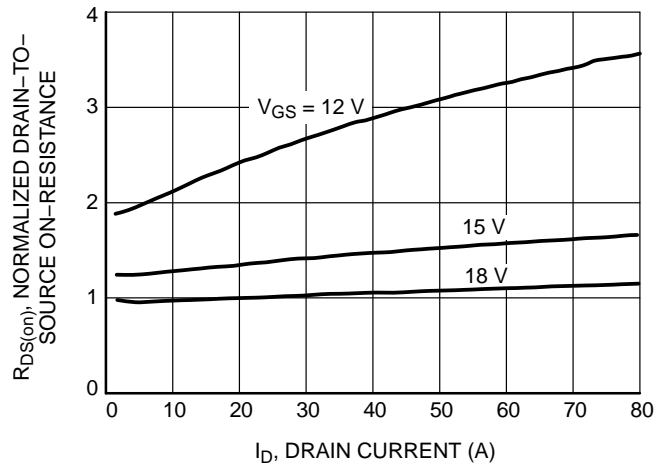

Figure 2. Normalized On-Resistance vs. Drain Current and Gate Voltage

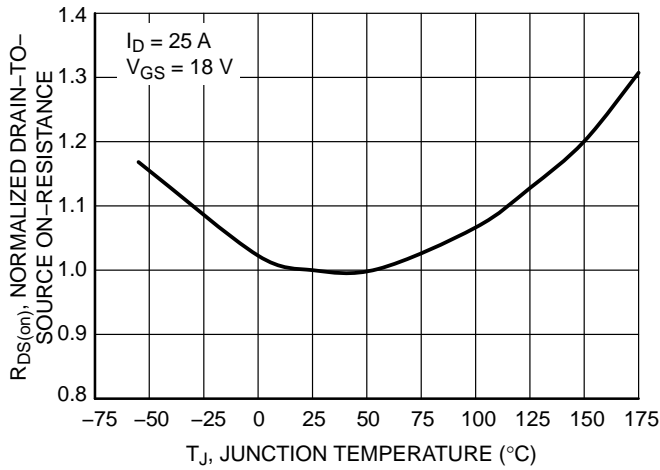

Figure 3. On-Resistance Variation with Temperature

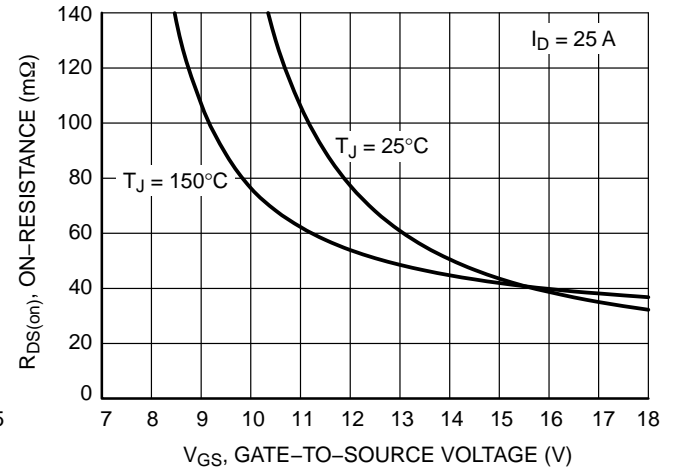

Figure 4. On-Resistance vs. Gate-to-Source Voltage

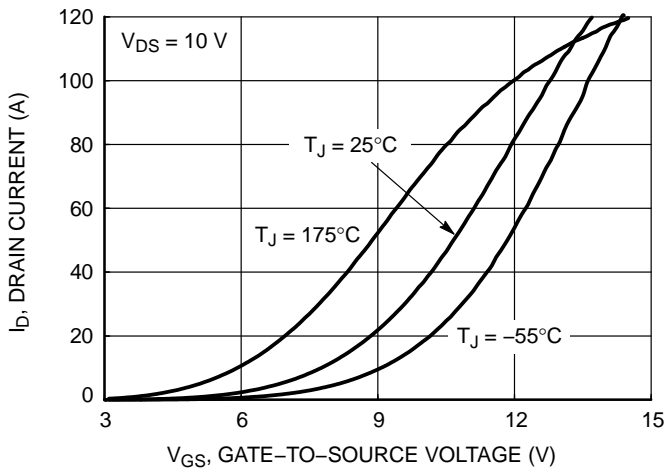

Figure 5. Transfer Characteristics

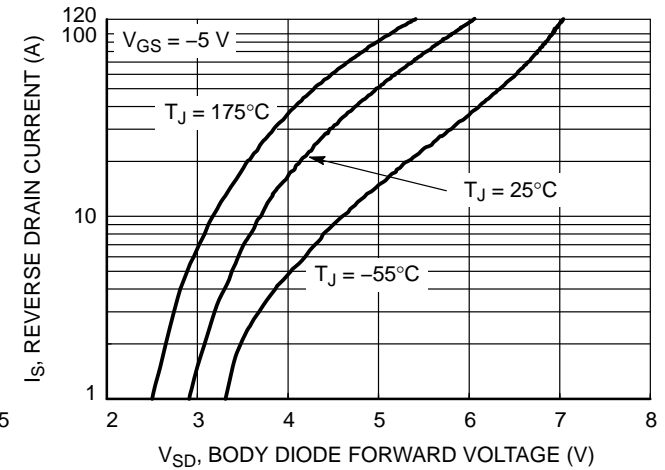

Figure 6. Diode Forward Voltage vs. Current

TYPICAL CHARACTERISTICS (Continued)

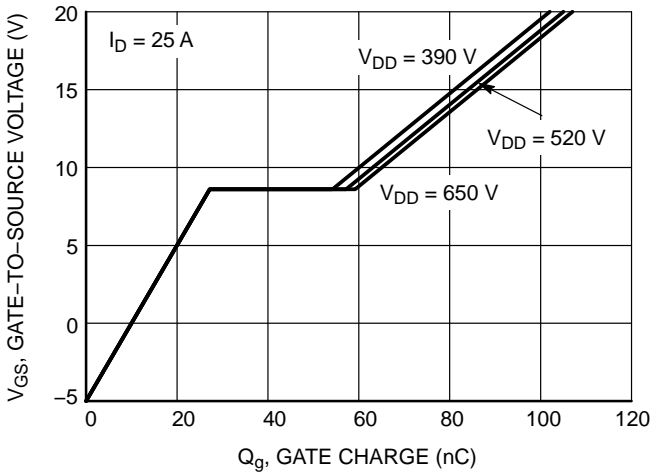

Figure 7. Gate-to-Source Voltage vs. Total Charge

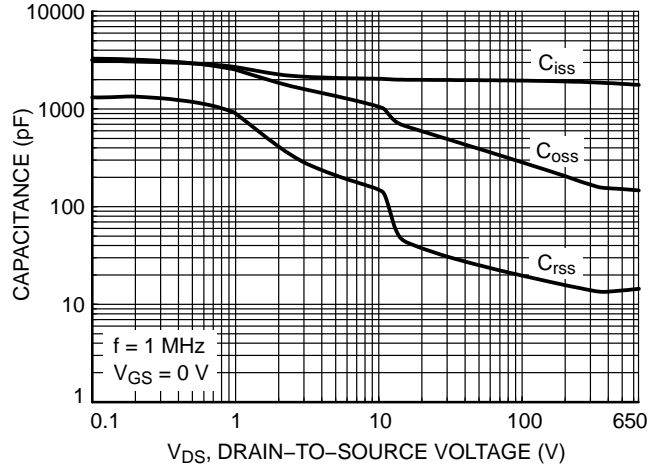

Figure 8. Capacitance vs. Drain-to-Source Voltage

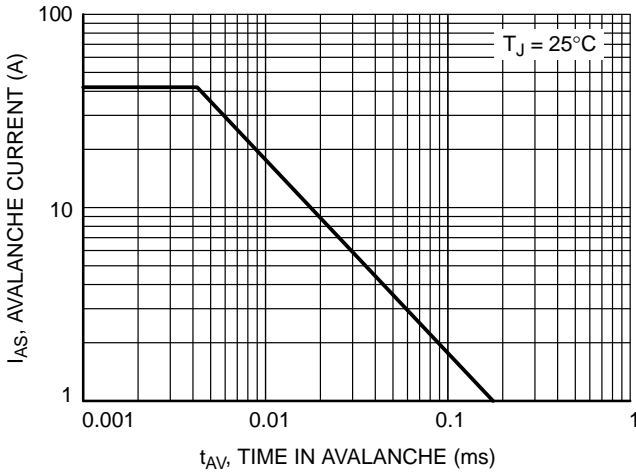

Figure 9. Unclamped Inductive Switching Capability

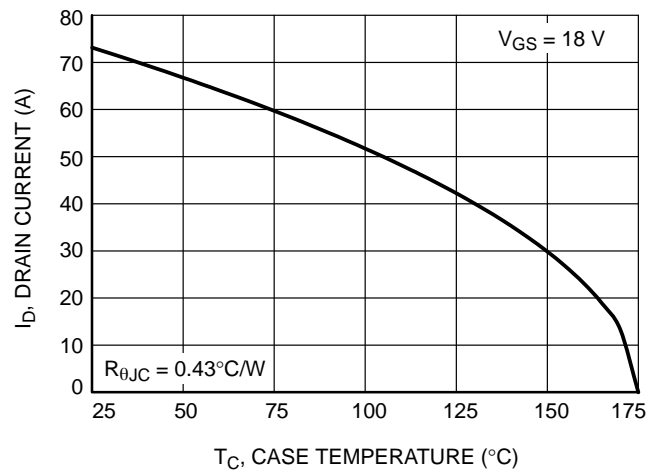

Figure 10. Maximum Continuous Drain Current vs. Case Temperature

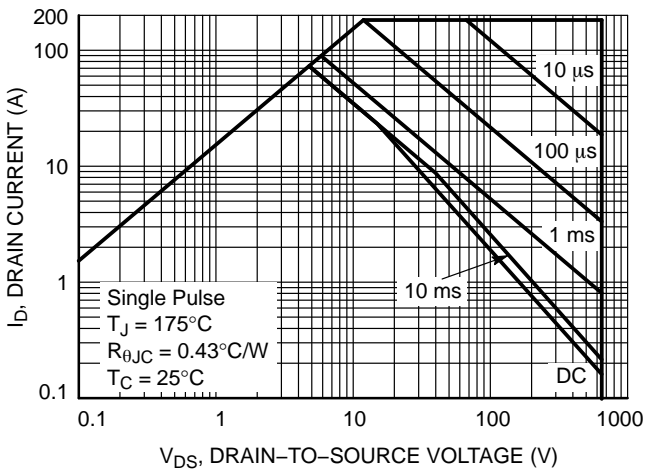

Figure 11. Safe Operating Area

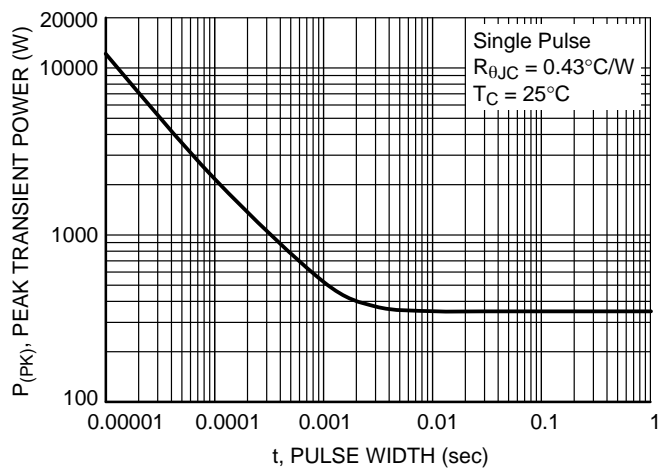

Figure 12. Single Pulse Maximum Power Dissipation

NTMT045N065SC1

TYPICAL CHARACTERISTICS (Continued)

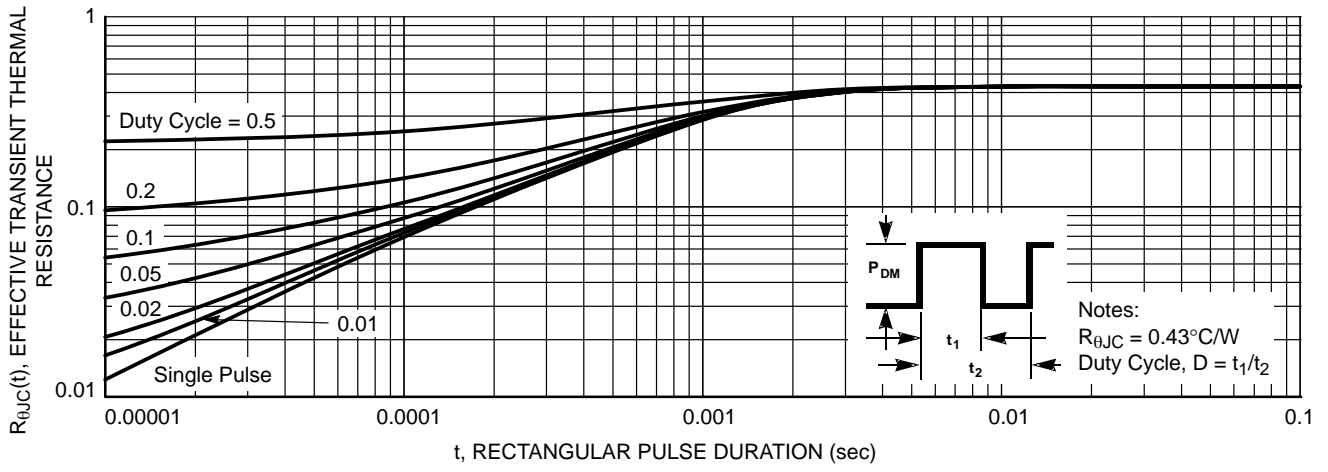
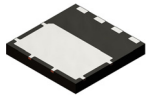

Figure 13. Transient Thermal Impedance

MECHANICAL CASE OUTLINE

PACKAGE DIMENSIONS

ON Semiconductor®



TDFN4 8x8, 2P
CASE 520AB
ISSUE O

DATE 24 APR 2019

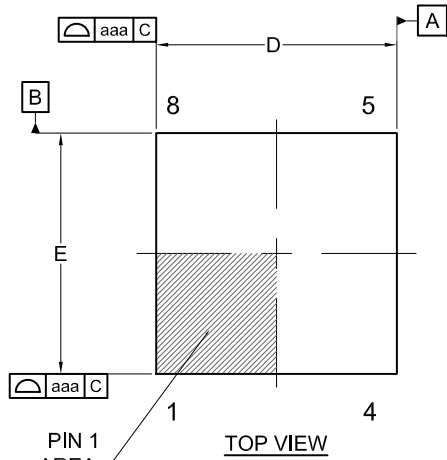

NOTES: UNLESS OTHERWISE SPECIFIED
 A) DOES NOT FULLY CONFORM TO JEDEC REGISTRATION MO-220.
 B) ALL DIMENSIONS ARE IN MILLIMETERS.
 C) DIMENSIONS DO NOT INCLUDE BURRS OR MOLD FLASH. MOLD FLASH OR BURRS DOES NOT EXCEED 0.10MM.
 D) IT IS RECOMMENDED TO HAVE NO TRACES OR VIAS WITHIN THE KEEP OUT AREA.

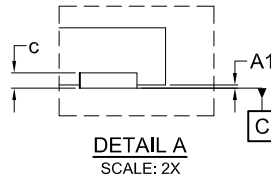

DIM	MILLIMETERS		
	MIN.	NOM.	MAX.
A	0.90	1.00	1.10
A1	0.00	---	0.05
b	0.90	1.00	1.10
c	0.10	0.20	0.30
D	7.90	8.00	8.10
D1	7.10	7.20	7.30
E	7.90	8.00	8.10
E1	4.25	4.35	4.45
E2	0.15	0.25	0.35
e	2.00 BSC		
e1	6.00 BSC		
e2	3.10 BSC		
K	(2.75)		
L	0.40	0.50	0.60
aaa	0.10		
bbb	0.10		
ccc	0.05		
eee	0.05		
fff	0.10		
ggg	0.15		

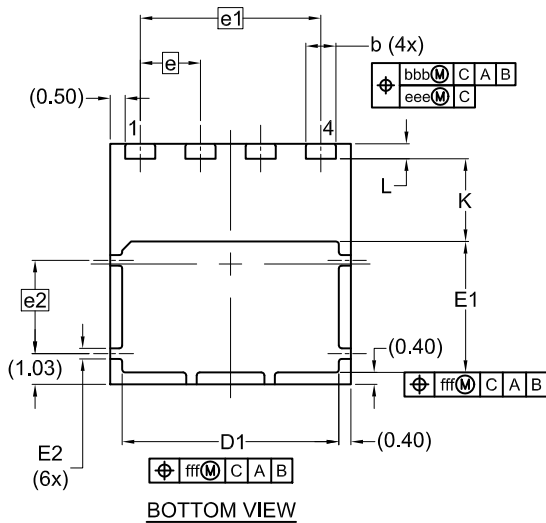
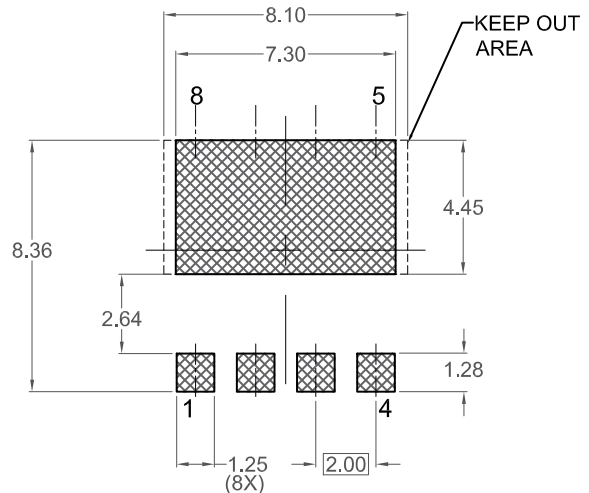
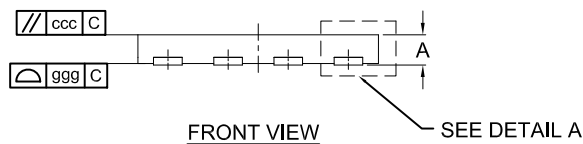

GENERIC MARKING DIAGRAM*

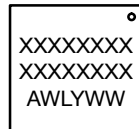

XXXX = Specific Device Code
 A = Assembly Location
 L = Wafer Lot
 Y = Year
 W = Work Week
 ■ = Pb-Free Package

*This information is generic. Please refer to device data sheet for actual part marking. Pb-Free indicator, "G" or microdot "■", may or may not be present. Some products may not follow the Generic Marking.

DOCUMENT NUMBER:	98AON73688G	Electronic versions are uncontrolled except when accessed directly from the Document Repository. Printed versions are uncontrolled except when stamped "CONTROLLED COPY" in red.
DESCRIPTION:	TDFN4 8x8, 2P	PAGE 1 OF 1

ON Semiconductor and ON are trademarks of Semiconductor Components Industries, LLC dba ON Semiconductor or its subsidiaries in the United States and/or other countries. ON Semiconductor reserves the right to make changes without further notice to any products herein. ON Semiconductor makes no warranty, representation or guarantee regarding the suitability of its products for any particular purpose, nor does ON Semiconductor assume any liability arising out of the application or use of any product or circuit, and specifically disclaims any and all liability, including without limitation special, consequential or incidental damages. ON Semiconductor does not convey any license under its patent rights nor the rights of others.

onsemi, **Onsemi**, and other names, marks, and brands are registered and/or common law trademarks of Semiconductor Components Industries, LLC dba "**onsemi**" or its affiliates and/or subsidiaries in the United States and/or other countries. **onsemi** owns the rights to a number of patents, trademarks, copyrights, trade secrets, and other intellectual property. A listing of **onsemi**'s product/patent coverage may be accessed at www.onsemi.com/site/pdf/Patent-Marking.pdf. **onsemi** reserves the right to make changes at any time to any products or information herein, without notice. The information herein is provided "as-is" and **onsemi** makes no warranty, representation or guarantee regarding the accuracy of the information, product features, availability, functionality, or suitability of its products for any particular purpose, nor does **onsemi** assume any liability arising out of the application or use of any product or circuit, and specifically disclaims any and all liability, including without limitation special, consequential or incidental damages. Buyer is responsible for its products and applications using **onsemi** products, including compliance with all laws, regulations and safety requirements or standards, regardless of any support or applications information provided by **onsemi**. "Typical" parameters which may be provided in **onsemi** data sheets and/or specifications can and do vary in different applications and actual performance may vary over time. All operating parameters, including "Typicals" must be validated for each customer application by customer's technical experts. **onsemi** does not convey any license under any of its intellectual property rights nor the rights of others. **onsemi** products are not designed, intended, or authorized for use as a critical component in life support systems or any FDA Class 3 medical devices or medical devices with a same or similar classification in a foreign jurisdiction or any devices intended for implantation in the human body. Should Buyer purchase or use **onsemi** products for any such unintended or unauthorized application, Buyer shall indemnify and hold **onsemi** and its officers, employees, subsidiaries, affiliates, and distributors harmless against all claims, costs, damages, and expenses, and reasonable attorney fees arising out of, directly or indirectly, any claim of personal injury or death associated with such unintended or unauthorized use, even if such claim alleges that **onsemi** was negligent regarding the design or manufacture of the part. **onsemi** is an Equal Opportunity/Affirmative Action Employer. This literature is subject to all applicable copyright laws and is not for resale in any manner.

ADDITIONAL INFORMATION

TECHNICAL PUBLICATIONS:

Technical Library: www.onsemi.com/design/resources/technical-documentation
onsemi Website: www.onsemi.com

ONLINE SUPPORT: www.onsemi.com/support

For additional information, please contact your local Sales Representative at www.onsemi.com/support/sales