

THIS DOCUMENT IS SUBJECT TO CHANGE WITHOUT NOTICE. IT IS CONFIDENTIAL AND A PROPERTY OF AMPHENOL LTW. DISCLOSURE TO THIRD PARTY HAS TO BE AUTHORIZED BY AMPHENOL LTW.

REV.	ECN NO.	DATE	SIGN	DESCRIPTION
A		2022-01-20	Jiahe Lin	Rev.01 To Rev.A

MI2D-XXPMMR-EE0001
 XX: No. Of Pin

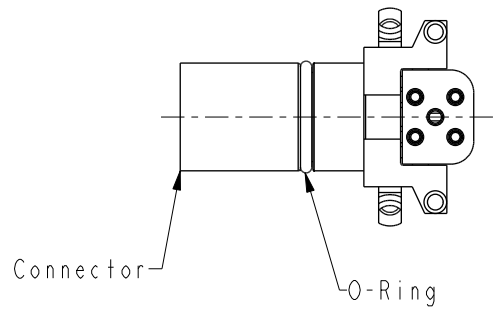
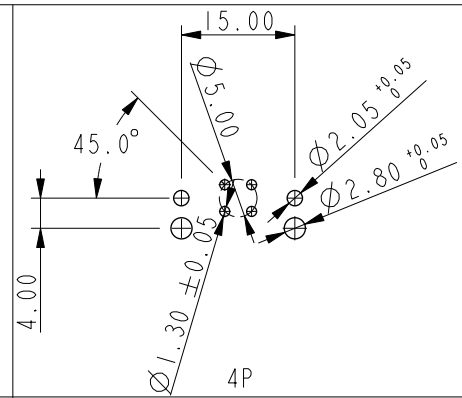
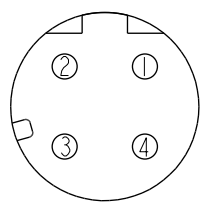
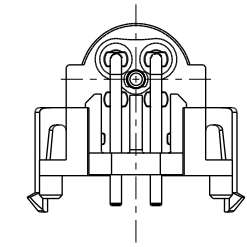
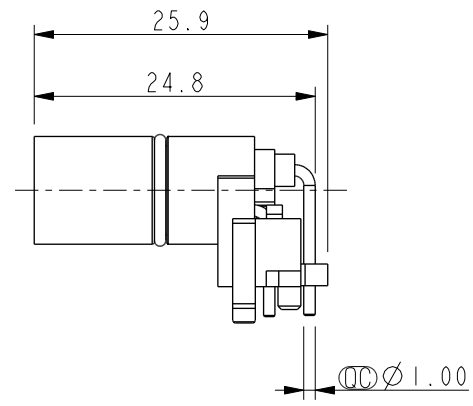
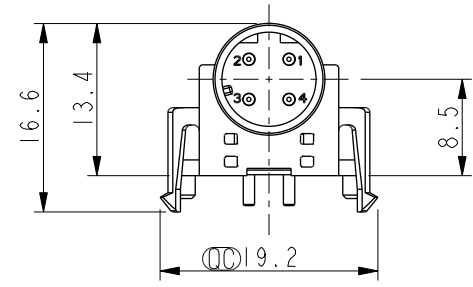
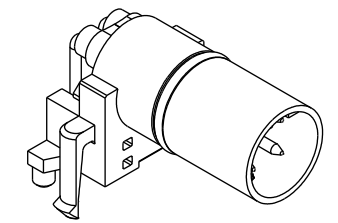
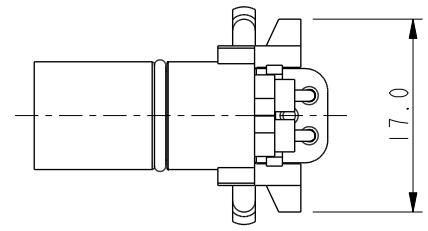

Note:
 * RoHS Compliant
 * \varnothing Important dimension
 * Waterproof rate: Non-Waterproof
 * Connector
 Housing: Thermoplastic, Black
 Pin: Copper alloy, Gold plated
 O-Ring: Rubber, Black
 * For pcb thickness max: 1.6mm

Pin Assignment
Front View

Recommended PCB Layout

UNIT:mm		
TOLERANCE	.X ±0.25	
	.XX ±0.1	
	.XXX ±0.05	
ANGLES	±1°	

TITLE N SEN, MI2 D, RECEPTACLE, M, M, PCB R		
SCALE 3:2	SIZE A4	SHEET 1 OF 1
REV. A	WC-REV. A.1	\varnothing : Inspection item

Amphenol LTW
 安費諾亮泰企業股份有限公司

ITEM NO	DRAWN BY Jiahe Lin	DATE 2022-01-20
DWG NO MI2D-XXPMMR-EE0001	CHECKED BY Allen Pan	DATE 2022-01-20
CUSTOMER ALTW	APPROVED BY Fred Lee	DATE 2022-01-20