

MIRELLA-50-W-PIN

~40° wide beam

SPECIFICATION:

Dimensions	Ø 49.9 mm
Height	23.9 mm
Fastening	pin
ROHS compliant	yes ⓘ

MATERIALS:

Component	Type	Material	Colour	Finish	Coating
MIRELLA-50-W-PIN	Reflector	PC	metal		lacquer





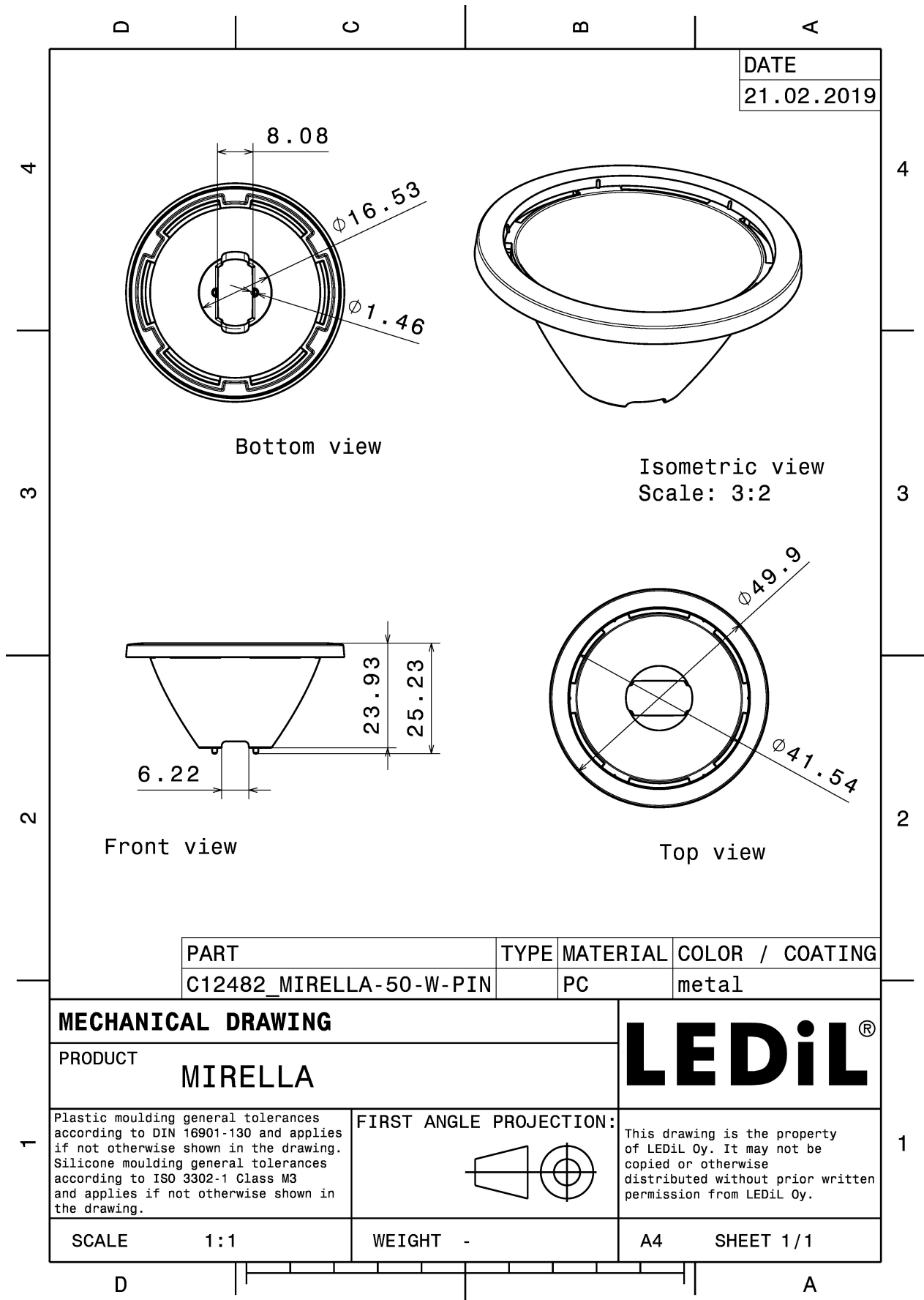

ORDERING INFORMATION:

Component	Qty in box	MOQ	MPQ	Box weight (kg)
C12482_MIRELLA-50-W-PIN » Box size: 480 x 280 x 300 mm	336	112	28	2.7



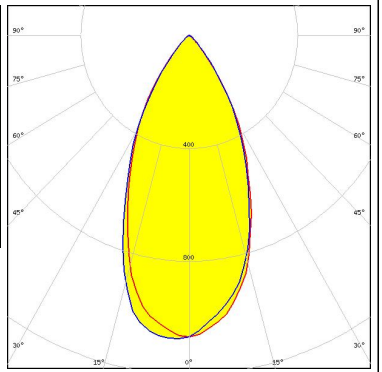

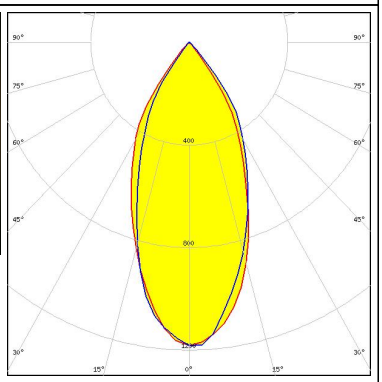
See also our general installation guide: www.ledil.com/installation_guide

OPTICAL RESULTS (MEASURED):

<p>bridgelux</p> <p>LED SM4 FWHM / FWTM 49.0° / 82.0° Efficiency 77 % Peak intensity 1.1 cd/lm LEDs/each optic 1 Light colour White Required components: C12479_MIRELLA-DL</p>		
<p>bridgelux</p> <p>LED SM4 FWHM / FWTM 44.0° / 78.0° Efficiency 78 % Peak intensity 1.2 cd/lm LEDs/each optic 1 Light colour White Required components: C13333_MIRELLA-CL</p>		
<p>CREE LED</p> <p>LED MHB-A/B FWHM / FWTM 49.0° / 82.0° Efficiency 82 % Peak intensity 1.2 cd/lm LEDs/each optic 1 Light colour White Required components: C13333_MIRELLA-CL</p>		
<p>CREE LED</p> <p>LED MHB-A/B FWHM / FWTM 45.0° / 88.0° Efficiency 87 % Peak intensity 1.4 cd/lm LEDs/each optic 1 Light colour White Required components:</p>		

OPTICAL RESULTS (MEASURED):

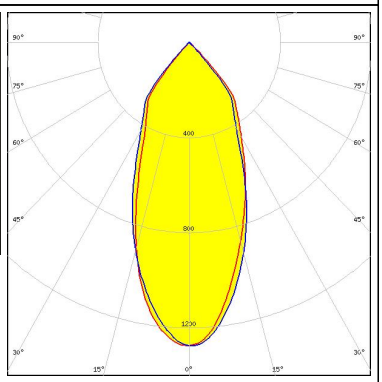
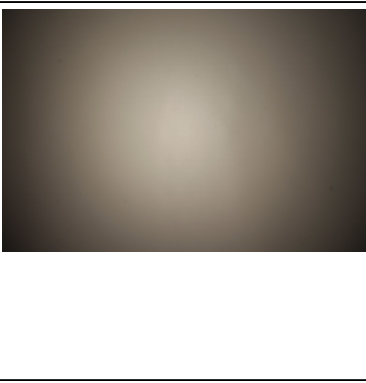
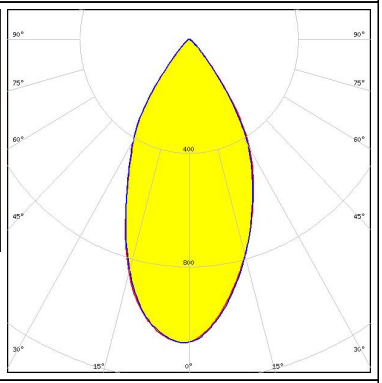
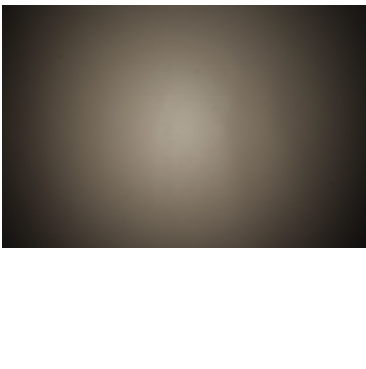
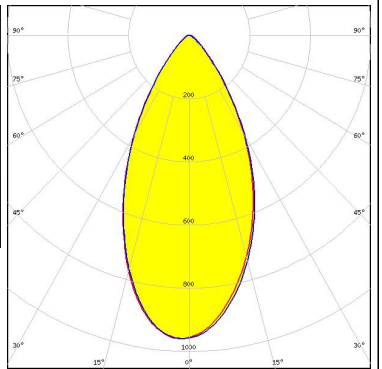
<p>CREE ⇄ LED</p> <p>LED MHB-A/B FWHM / FWTM 51.0° / 84.0° Efficiency 82 % Peak intensity 1.2 cd/lm LEDs/each optic 1 Light colour White Required components: C12479_MIRELLA-DL</p>		
<p>CREE ⇄ LED</p> <p>LED XHP50 FWHM / FWTM 44.0° / 86.0° Efficiency 89 % Peak intensity 1.3 cd/lm LEDs/each optic 1 Light colour White Required components:</p>		
<p>CREE ⇄ LED</p> <p>LED XHP50 FWHM / FWTM 51.0° / 83.0° Efficiency 84 % Peak intensity 1.1 cd/lm LEDs/each optic 1 Light colour White Required components: C12479_MIRELLA-DL</p>		
<p>CREE ⇄ LED</p> <p>LED XHP50 FWHM / FWTM 51.0° / 88.0° Efficiency 81 % Peak intensity 1 cd/lm LEDs/each optic 1 Light colour White Required components: C13723_MIRELLA-RZL</p>		

OPTICAL RESULTS (MEASURED):

CREE LED

LED XHP50
 FWHM / FWTM 48.0° / 80.0°
 Efficiency 83 %
 Peak intensity 1.1 cd/lm
 LEDs/each optic 1
 Light colour White
 Required components:
 C13333_MIRELLA-CL

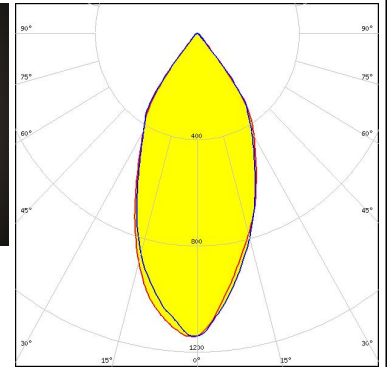
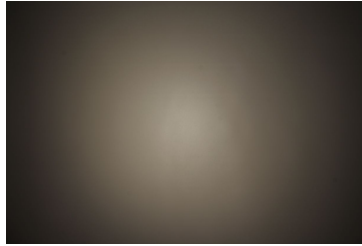

CREE LED

LED XM-L
 FWHM / FWTM 45.0° / 79.0°
 Efficiency 86 %
 Peak intensity 1.4 cd/lm
 LEDs/each optic 1
 Light colour White
 Required components:
 C13333_MIRELLA-CL

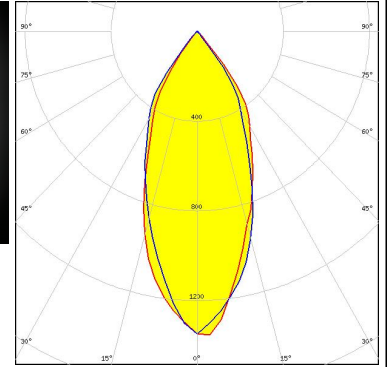

CREE LED

LED XM-L
 FWHM / FWTM 46.0° / 86.0°
 Efficiency 80 %
 Peak intensity 1 cd/lm
 LEDs/each optic 1
 Light colour White
 Required components:
 C12479_MIRELLA-DL

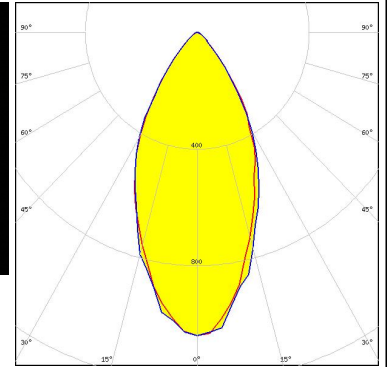
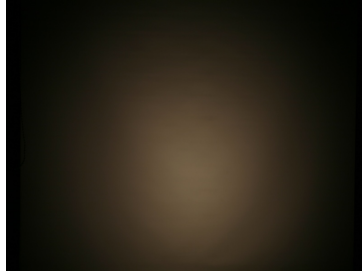





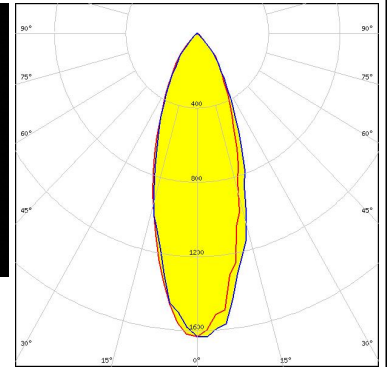

CREE LED

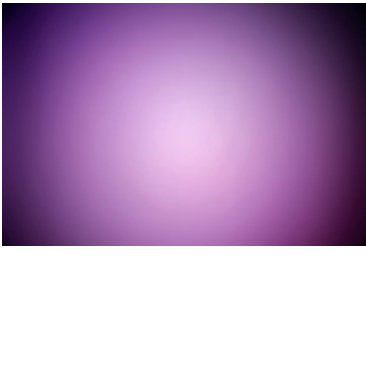
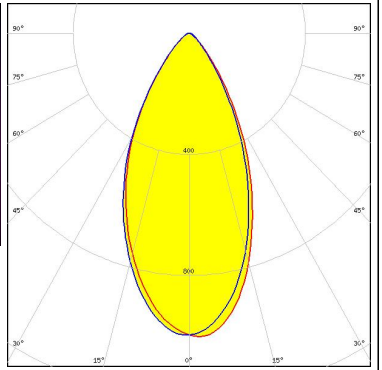
LED XM-L
 FWHM / FWTM 32.0° / 80.0°
 Efficiency 88 %
 Peak intensity 1.6 cd/lm
 LEDs/each optic 1
 Light colour White
 Required components:

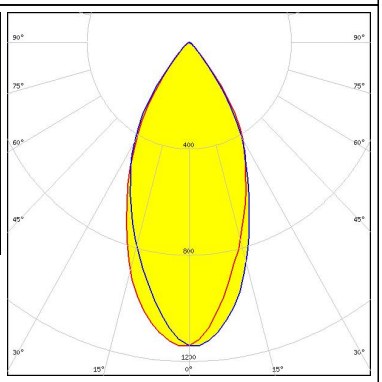

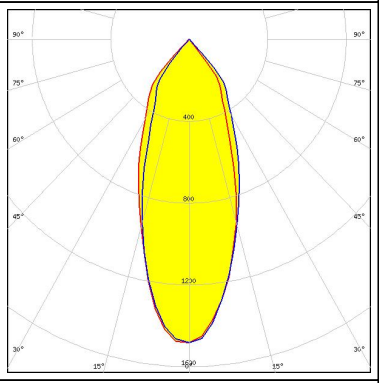
OPTICAL RESULTS (MEASURED):

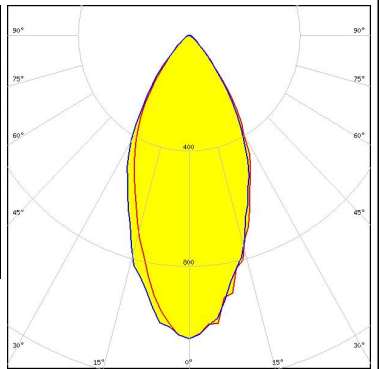
<p>CREE  LED</p> <p>LED XM-L RGBW (XMLCTW) FWHM / FWTM 50.0° / 87.0° Efficiency 81 % Peak intensity 1 cd/lm LEDs/each optic 1 Light colour White Required components: C13723_MIRELLA-RZL</p>		
<p>CREE  LED</p> <p>LED XM-L2 FWHM / FWTM 49.0° / 83.0° Efficiency 81 % Peak intensity 1.1 cd/lm LEDs/each optic 1 Light colour White Required components: C12479_MIRELLA-DL</p>		
<p>CREE  LED</p> <p>LED XM-L2 FWHM / FWTM 39.0° / 83.0° Efficiency 89 % Peak intensity 1.5 cd/lm LEDs/each optic 1 Light colour White Required components:</p>		
<p>CREE  LED</p> <p>LED XP-G FWHM / FWTM 50.0° / 86.0° Efficiency 80 % Peak intensity 1.1 cd/lm LEDs/each optic 1 Light colour White Required components: C12479_MIRELLA-DL</p>		

OPTICAL RESULTS (MEASURED):

CREE → LED

LED XP-G
 FWHM / FWTM 34.0° / 78.0°
 Efficiency 86 %
 Peak intensity 1.7 cd/m
 LEDs/each optic 1
 Light colour White
 Required components:

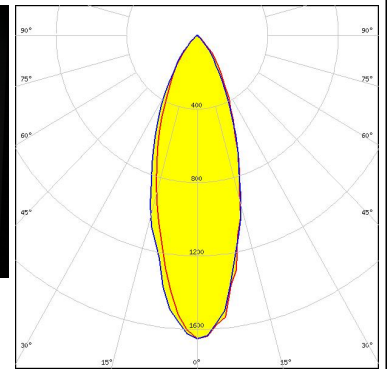

CREE → LED

LED XP-G
 FWHM / FWTM 41.0° / 79.0°
 Efficiency 81 %
 Peak intensity 1.4 cd/m
 LEDs/each optic 1
 Light colour White
 Required components:
 C13333_MIRELLA-CL

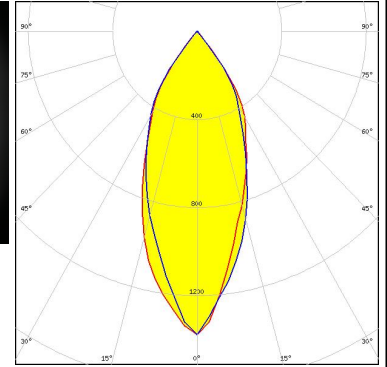

CREE → LED

LED XP-G2
 FWHM / FWTM 45.0° / 81.0°
 Efficiency 83 %
 Peak intensity 1.3 cd/m
 LEDs/each optic 1
 Light colour White
 Required components:
 C12479_MIRELLA-DL

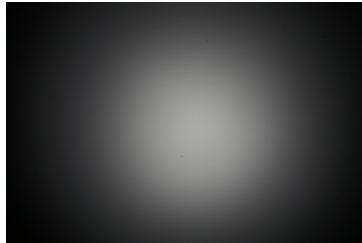

CREE → LED

LED XP-G2
 FWHM / FWTM 36.0° / 84.0°
 Efficiency 88 %
 Peak intensity 1.7 cd/m
 LEDs/each optic 1
 Light colour White
 Required components:



OPTICAL RESULTS (MEASURED):

CREE LED

LED XP-L HI
 FWHM / FWTM 35.0° / 84.0°
 Efficiency 87 %
 Peak intensity 1.7 cd/lm
 LEDs/each optic 1
 Light colour White
 Required components:



CREE LED

LED XT-E
 FWHM / FWTM 31.0° / 80.0°
 Efficiency 84 %
 Peak intensity 1.2 cd/lm
 LEDs/each optic 1
 Light colour White
 Required components:

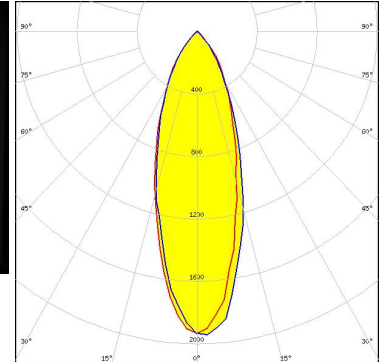

CREE LED

LED XT-E
 FWHM / FWTM 46.0° / 86.0°
 Efficiency 77 %
 Peak intensity 1 cd/lm
 LEDs/each optic 1
 Light colour White
 Required components:
 C12479_MIRELLA-DL

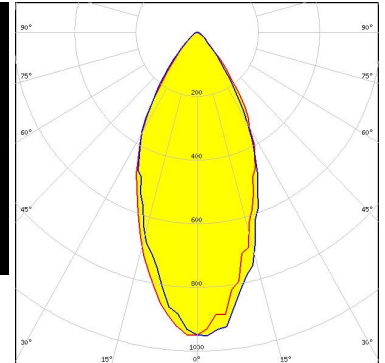

CREE LED

LED XT-E
 FWHM / FWTM 41.0° / 77.0°
 Efficiency 83 %
 Peak intensity 1.4 cd/lm
 LEDs/each optic 1
 Light colour White
 Required components:
 C13333_MIRELLA-CL

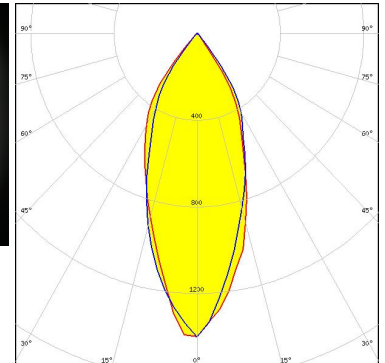
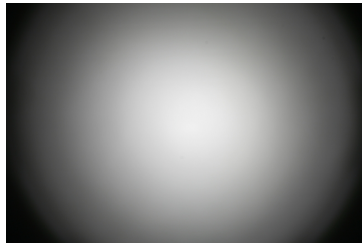

OPTICAL RESULTS (MEASURED):

LUMILEDS

LED LUXEON 5050 Round LES
 FWHM / FWTM 38.0° / 83.0°
 Efficiency 89 %
 Peak intensity 1.5 cd/lm
 LEDs/each optic 1
 Light colour White
 Required components:

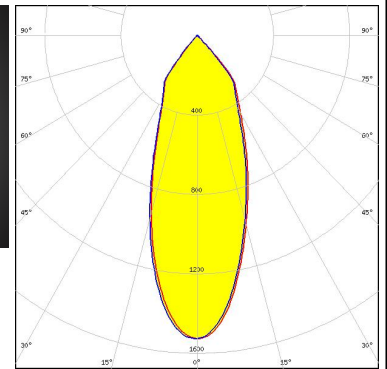

LUMILEDS

LED LUXEON A
 FWHM / FWTM 48.0° / 86.0°
 Efficiency 80 %
 Peak intensity 1 cd/lm
 LEDs/each optic 1
 Light colour White
 Required components:
 C12479_MIRELLA-DL

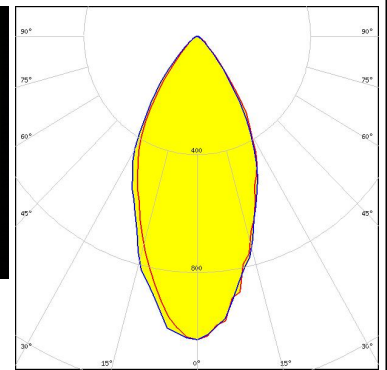
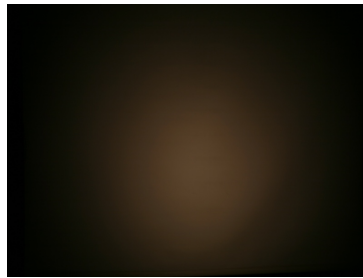

LUMILEDS

LED LUXEON A
 FWHM / FWTM 41.0° / 78.0°
 Efficiency 84 %
 Peak intensity 1.4 cd/lm
 LEDs/each optic 1
 Light colour White
 Required components:
 C13333_MIRELLA-CL

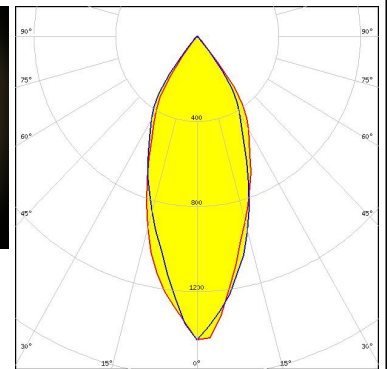
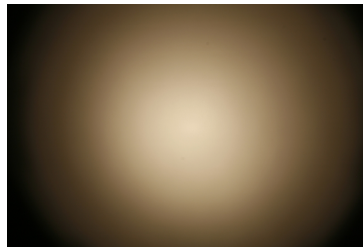

LUMILEDS

LED LUXEON A
 FWHM / FWTM 30.0° / 76.0°
 Efficiency 86 %
 Peak intensity 1.7 cd/lm
 LEDs/each optic 1
 Light colour White
 Required components:

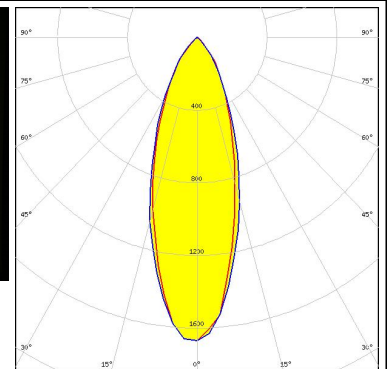
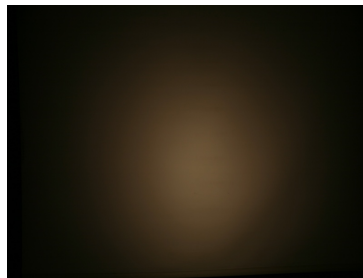

OPTICAL RESULTS (MEASURED):

LUMILEDS

LED LUXEON C
 FWHM / FWTM 47.0° / 85.0°
 Efficiency 77 %
 Peak intensity 1 cd/lm
 LEDs/each optic 4
 Light colour RGBW
 Required components:
 C13723_MIRELLA-RZL

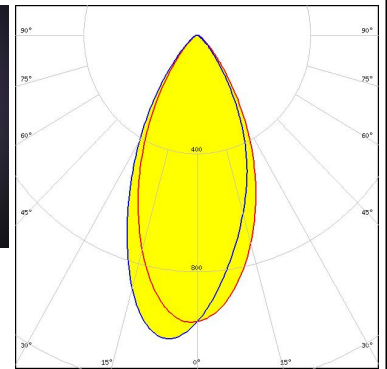
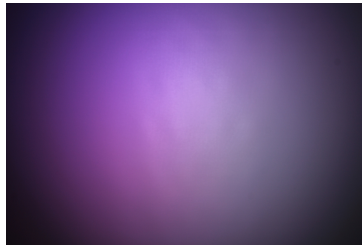

LUMILEDS

LED LUXEON M/MX
 FWHM / FWTM 47.0° / 80.0°
 Efficiency 83 %
 Peak intensity 1.2 cd/lm
 LEDs/each optic 1
 Light colour White
 Required components:
 C13333_MIRELLA-CL

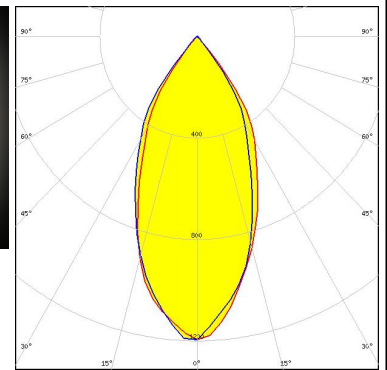
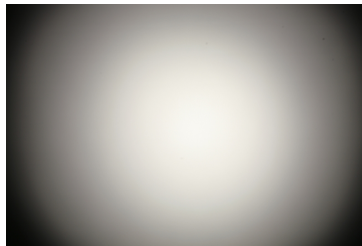

LUMILEDS

LED LUXEON M/MX
 FWHM / FWTM 39.0° / 84.0°
 Efficiency 87 %
 Peak intensity 1.4 cd/lm
 LEDs/each optic 1
 Light colour White
 Required components:

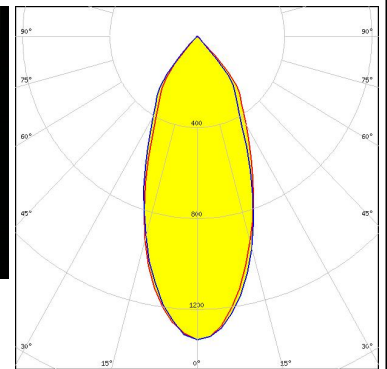

LUMILEDS

LED LUXEON M/MX
 FWHM / FWTM 54.0° / 90.0°
 Efficiency 80 %
 Peak intensity 1 cd/lm
 LEDs/each optic 1
 Light colour White
 Required components:
 C12479_MIRELLA-DL

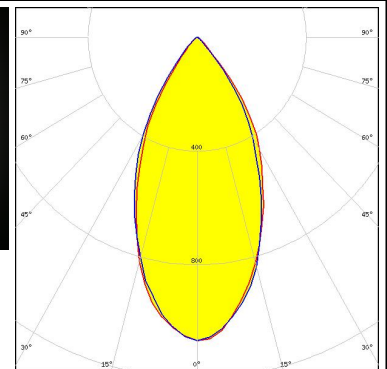
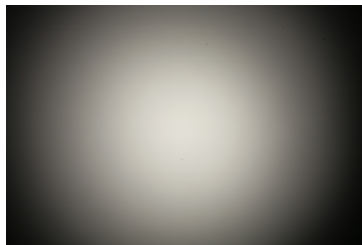

OPTICAL RESULTS (MEASURED):

LUMILEDS

LED LUXEON MZ
 FWHM / FWTM 32.0° / 79.0°
 Efficiency 87 %
 Peak intensity 2 cd/lm
 LEDs/each optic 1
 Light colour White
 Required components:

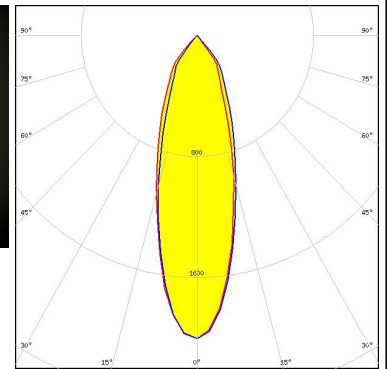

LUMILEDS

LED LUXEON MZ
 FWHM / FWTM 40.0° / 77.0°
 Efficiency 82 %
 Peak intensity 1.5 cd/lm
 LEDs/each optic 1
 Light colour White
 Required components:
 C12479_MIRELLA-DL

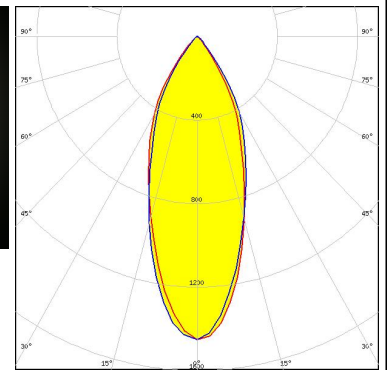

LUMILEDS

LED LUXEON Z
 FWHM / FWTM 46.0° / 84.0°
 Efficiency 80 %
 Peak intensity 1.1 cd/lm
 LEDs/each optic 4
 Light colour RGBW
 Required components:
 C13723_MIRELLA-RZL

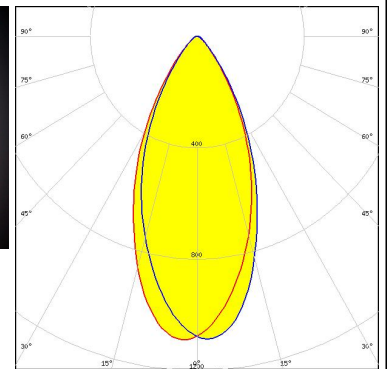
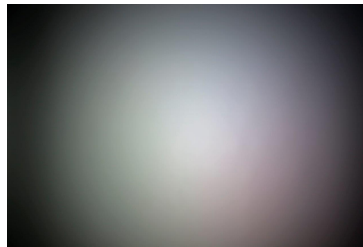



NICHIA

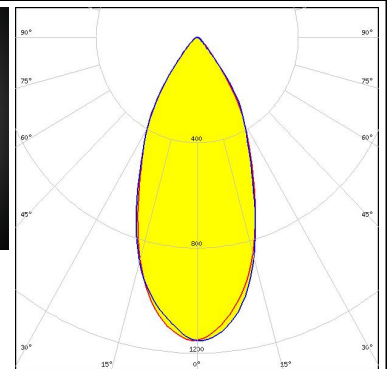
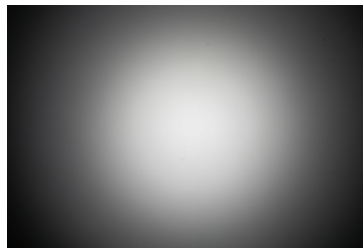

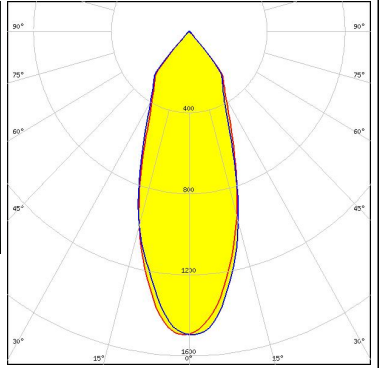

LED NS9x383
 FWHM / FWTM 46.0° / 81.0°
 Efficiency 83 %
 Peak intensity 1.2 cd/lm
 LEDs/each optic 1
 Light colour White
 Required components:
 C12479_MIRELLA-DL

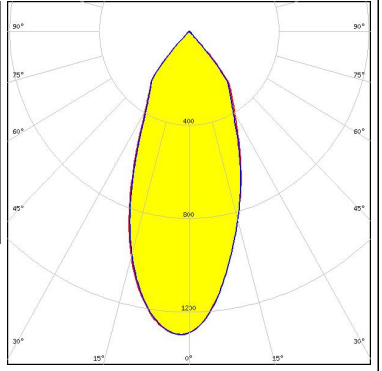
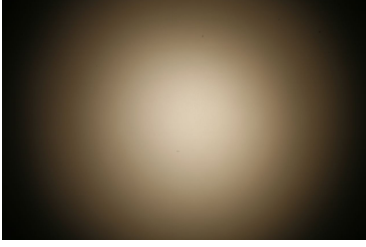
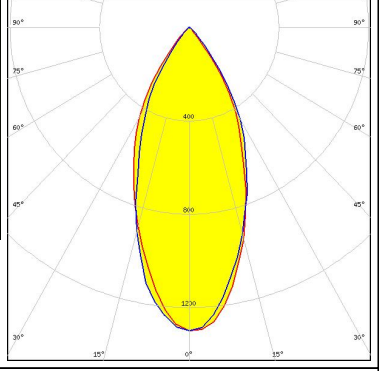
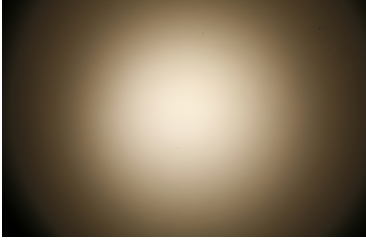
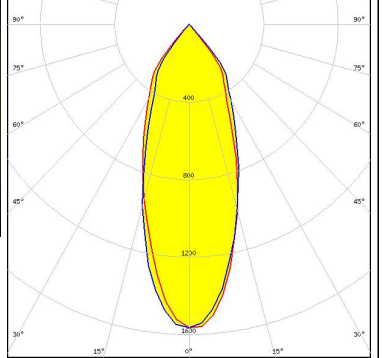

OPTICAL RESULTS (MEASURED):

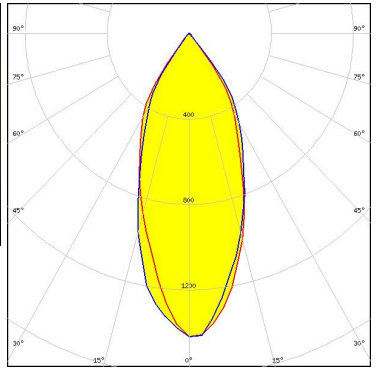
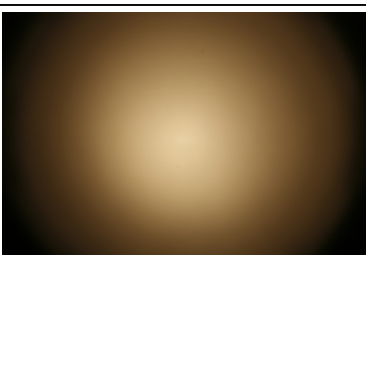
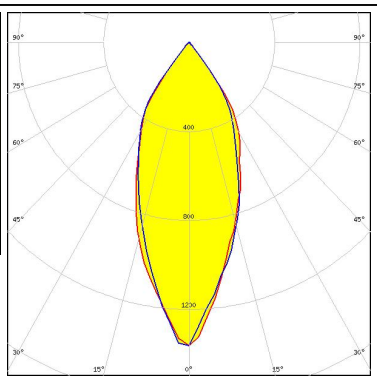
<p>NICHIA</p> <p>LED NS9x383 FWHM / FWTM 39.0° / 84.0° Efficiency 89 % Peak intensity 1.5 cd/m LEDs/each optic 1 Light colour White Required components:</p>		
<p>NICHIA</p> <p>LED NV4x144A FWHM / FWTM 43.0° / 85.0° Efficiency 87 % Peak intensity 1.3 cd/m LEDs/each optic 1 Light colour White Required components:</p>		
<p>OSRAM <small>Opto Semiconductors</small></p> <p>LED Duris S8 FWHM / FWTM 44.0° / 75.0° Efficiency 83 % Peak intensity 1.3 cd/m LEDs/each optic 1 Light colour White Required components: C12479_MIRELLA-DL</p>		
<p>OSRAM <small>Opto Semiconductors</small></p> <p>LED Duris S8 FWHM / FWTM 39.0° / 82.0° Efficiency 88 % Peak intensity 1.6 cd/m LEDs/each optic 1 Light colour White Required components:</p>		

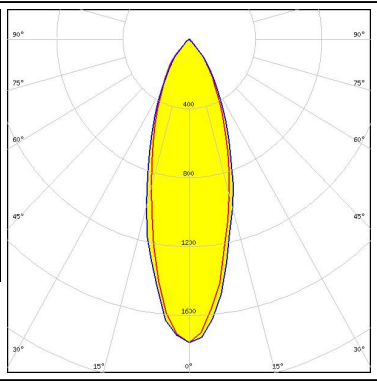
OPTICAL RESULTS (MEASURED):

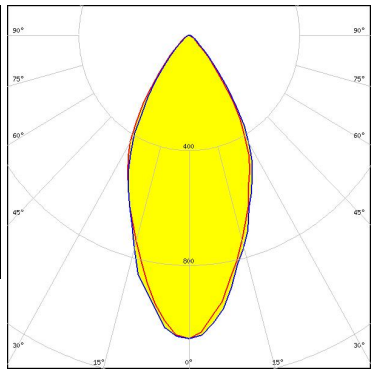
<p>OSRAM Opto Semiconductors</p> <p>LED Duris S8</p> <p>FWHM / FWTM 42.0° / 78.0°</p> <p>Efficiency 84 %</p> <p>Peak intensity 1.4 cd/m</p> <p>LEDs/each optic 1</p> <p>Light colour White</p> <p>Required components: C13333_MIRELLA-CL</p>		
<p>OSRAM Opto Semiconductors</p> <p>LED OSLOM Square EC</p> <p>FWHM / FWTM 41.0° / 78.0°</p> <p>Efficiency 83 %</p> <p>Peak intensity 1.4 cd/m</p> <p>LEDs/each optic 1</p> <p>Light colour White</p> <p>Required components: C13333_MIRELLA-CL</p>		
<p>OSRAM Opto Semiconductors</p> <p>LED OSLOM Square EC</p> <p>FWHM / FWTM 32.0° / 76.0°</p> <p>Efficiency 85 %</p> <p>Peak intensity 1.8 cd/m</p> <p>LEDs/each optic 1</p> <p>Light colour White</p> <p>Required components:</p>		
<p>OSRAM Opto Semiconductors</p> <p>LED OSLOM Square EC</p> <p>FWHM / FWTM 50.0° / 85.0°</p> <p>Efficiency 79 %</p> <p>Peak intensity 1.1 cd/m</p> <p>LEDs/each optic 1</p> <p>Light colour White</p> <p>Required components: C12479_MIRELLA-DL</p>		

OPTICAL RESULTS (MEASURED):

OSRAM

Opto Semiconductors

LED Ostar-SMT RGB
 FWHM / FWTM 48.0° / 85.0°
 Efficiency 81 %
 Peak intensity 1.1 cd/lm
 LEDs/each optic 1
 Light colour White
 Required components:
 C13723_MIRELLA-RZL

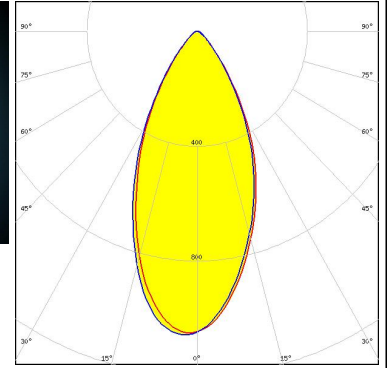
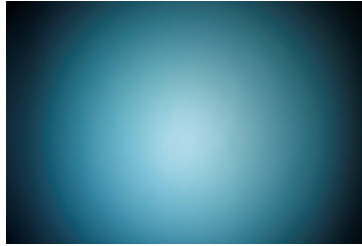

SAMSUNG

LED LH508A
 FWHM / FWTM 38.0° / 82.0°
 Efficiency 87 %
 Peak intensity 1.5 cd/lm
 LEDs/each optic 1
 Light colour White
 Required components:

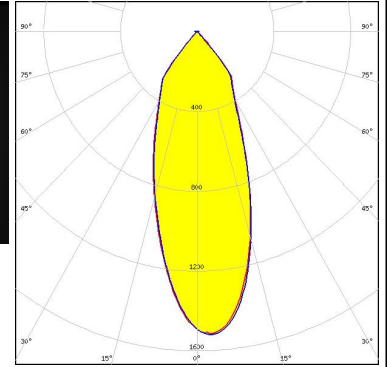

SEOUL SEMICONDUCTOR

LED F50360 (RGB)
 FWHM / FWTM 46.0° / 86.0°
 Efficiency 81 %
 Peak intensity 1.2 cd/lm
 LEDs/each optic 1
 Light colour White
 Required components:
 C13723_MIRELLA-RZL

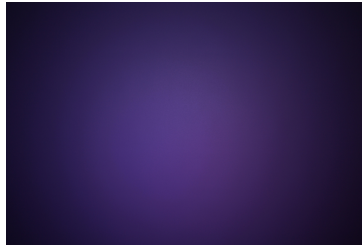

OPTICAL RESULTS (SIMULATED):

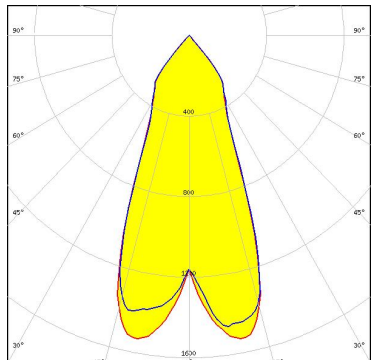
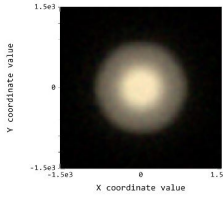
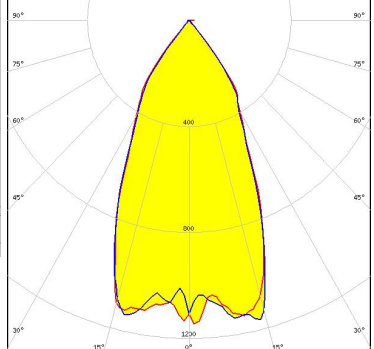
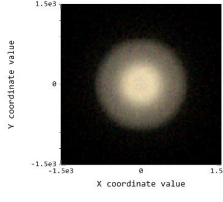
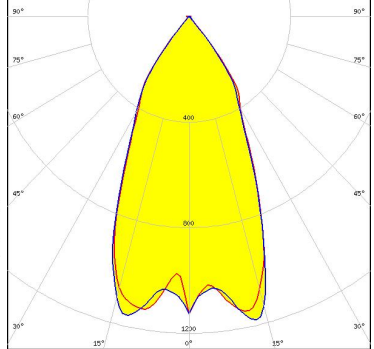
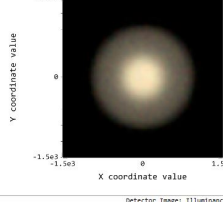
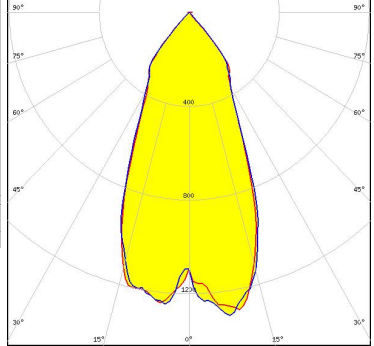
<p>LUMILEDS</p> <p>LED LUXEON 5258</p> <p>FWHM / FWTM 41.0° / 82.0°</p> <p>Efficiency 91 %</p> <p>Peak intensity 1.5 cd/lm</p> <p>LEDs/each optic 1</p> <p>Light colour White</p> <p>Required components:</p>		
<p>OSRAM Opto Semiconductors</p> <p>LED OSCONIQ P 7070</p> <p>FWHM / FWTM 50.0° / 81.0°</p> <p>Efficiency 87 %</p> <p>Peak intensity 1.2 cd/lm</p> <p>LEDs/each optic 1</p> <p>Light colour White</p> <p>Required components: C12479_MIRELLA-DL</p>	 <p>detector image: Illuminance</p> <p>21.4.2018 Detector: 1.000 Surface: 1 Size: 1000.000 V x 1000.000 = 1.000000m² Peak Intensity: 1.200000 Lumen/m² Total Power: 1.200000 Lumen</p>	
<p>OSRAM Opto Semiconductors</p> <p>LED OSCONIQ P 7070</p> <p>FWHM / FWTM 46.0° / 79.0°</p> <p>Efficiency 87 %</p> <p>Peak intensity 1.2 cd/lm</p> <p>LEDs/each optic 1</p> <p>Light colour White</p> <p>Required components: C13333_MIRELLA-CL</p>	 <p>detector image: Illuminance</p> <p>21.4.2018 Detector: 1.000 Surface: 1 Size: 1000.000 V x 1000.000 = 1.000000m² Peak Intensity: 1.200000 Lumen/m² Total Power: 1.200000 Lumen</p>	
<p>OSRAM Opto Semiconductors</p> <p>LED OSCONIQ P 7070</p> <p>FWHM / FWTM 45.0° / 84.0°</p> <p>Efficiency 91 %</p> <p>Peak intensity 1.3 cd/lm</p> <p>LEDs/each optic 1</p> <p>Light colour White</p> <p>Required components:</p>	 <p>detector image: Illuminance</p> <p>21.4.2018 Detector: 1.000 Surface: 1 Size: 1000.000 V x 1000.000 = 1.000000m² Peak Intensity: 1.300000 Lumen/m² Total Power: 1.300000 Lumen</p>	

OPTICAL RESULTS (SIMULATED):



GENERAL INFORMATION:

NOTE: The typical beam angle will be changed by different color, chip size and chip position tolerance. The typical total beam angle is the full angle measured where the luminous intensity is half of the peak value.

MATERIALS:

As part of our continuous research and improvement processes, and to ensure the best possible quality and availability of our products, LEDiL reserves the right to change material grades without notice.

PRODUCT DATA USER AGREEMENT AND DISCLAIMER:

The measured data in the provided downloadable LEDiL Product Datasheets and Mechanical 2D-Drawings is rounded and provided as reference for planning. LEDiL Oy's optical specifications have been verified by conducting performance testing of the products in accordance with the company's quality system. The reported data are averaged results of multiple measurements with typical variation. LEDiL Oy reserves the right to without prior notification make changes and improvements to its products.

LEDiL Oy assumes neither warranty, nor guarantee nor any other liability of any kind for the contents and correctness of the provided data. The provided data has been generated with highest diligence but the provided data may in reality not represent the complete possible variation range of all intrinsic parameters. Therefore, in certain cases a deviation from the provided data could occur.

LEDiL Oy reserves the right to undertake technical changes of its products without further notification which could lead to changes in the provided data. LEDiL Oy assumes no liability of any kind for the possible deviation from any provided data or any other damage resulting from the usage of the provided data.

The user agrees to this disclaimer and user agreement with the download or usage of the provided files.

LEDiL Oy

Joensuunkatu 13
FI-24240 SALO
Finland

LEDiL Inc.

228 West Page Street
Suite D
Sycamore IL 60178
USA

Ledil Optics Technology (Shenzhen) Co., Ltd.

405 , Block B
Casic Motor Building
Shenzhen 518057
P.R.CHINA

Local sales and technical support

[www.ledil.com/
where_to_buy](http://www.ledil.com/where_to_buy)

Shipping locations

Salo, Finland
Hong Kong, China

Distribution Partners

[www.ledil.com/
where_to_buy](http://www.ledil.com/where_to_buy)